

# INSTRUCTION MANUAL

## WITHSTANDING VOLTAGE TESTER STW-9000 SERIES

**STW-9901**

**STW-9801**

**STW-9902**

**STW-9802**

**STW-9903**

**STW-9803**

**STW-9904**

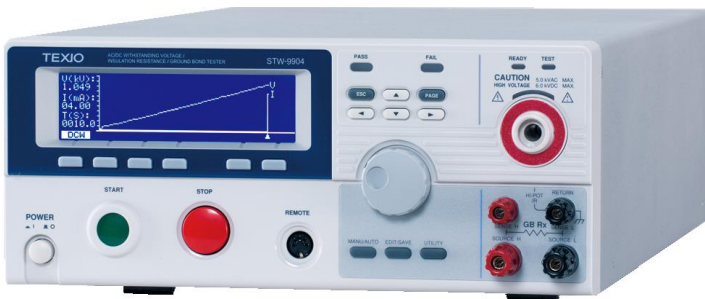

## ■ About Brands and Trademarks

“TEXIO” is the product brand name of our industrial electronic devices.

All company names and product names mentioned in this manual are the trademark or the registered trademark of each company or group in each country and region.

## ■ About the Instruction Manual

Permission from the copyright holder is needed to reprint the contents of this manual, in whole or in part. Be aware that the product specifications and the contents of this manual are subject to change for the purpose of improvement.

## ■ About firmware version

Firmware version corresponding to this manual will be as follows.

STW-9800 Series: Ver3.00 or higher

STW-9900 Series: Ver2.00 or higher

# CONTENTS

USING THE PRODUCT SAFELY .....	I -IV
1. GETING STARTED .....	1
1.1 STW-9000 Series Overview .....	1
1.2 Model Overview .....	2
1.3 Main Features .....	2
1.4 Accessories .....	2
1.5 Package Contents .....	3
1.6 Appearance .....	4
1.6.1 STW-9000 Front Panel .....	4
1.6.2 STW-9904 Front Panel .....	4
1.6.3 STW-9901/9902/9903 Rear Panel .....	6
1.6.4 STW-9904 Rear Panel .....	6
1.6.5 STW-9801/9802/9803 Rear Panel .....	7
1.7 Set Up .....	8
1.7.1 Line Voltage Connection and Power Up .....	8
1.7.2 Installing the Optional GP-IB Card .....	9
1.7.3 Workplace Precautions .....	10
1.7.4 Operating Precautions .....	11
1.7.5 Basic Safety Checks .....	12
2. OPERATION .....	13
2.1 Menu Tree .....	13
2.1.1 Menu Tree Overview .....	14
2.2 Test Lead Connection .....	16
2.2.1 ACW, DCW, IR Connection .....	16
2.2.2 GB Connection .....	17
2.3 ACW, DCW and GB Manual Testing .....	17
2.3.1 Choose/Recall a Manual Test Number .....	18
2.3.2 Edit Manual Test Settings .....	18
2.3.3 Setting the Test Function .....	19
2.3.4 Setting the Test Voltage or Test Current .....	19
2.3.5 Setting the Test Frequency .....	20
2.3.6 Setting the Upper and Lower Limits .....	20
2.3.7 Setting a Reference Value .....	22
2.3.8 Setting the Test Time (Timer) .....	22
2.3.9 Setting the Ramp Up Time .....	24
2.3.10 Creating a MANU Test File Name .....	24
2.3.11 Setting the ARC Mode .....	25
2.3.12 Setting PASS HOLD .....	26
2.3.13 Setting FAIL MODE .....	27
2.3.14 Setting MAX HOLD .....	28
2.3.15 Setting the Grounding Mode .....	29
2.3.16 Saving and Exiting EDIT Status .....	32
2.3.17 Running a MANU Test .....	32
2.3.18 PASS / FAIL MANU Test .....	35
2.3.19 Zeroing of the Test Leads (GB only) .....	39

2.3.20 Special MANU Test Mode (000) .....	41
2.4 Automatic Tests .....	44
2.4.1 Choose/Recall an Automatic Test .....	44
2.4.2 Edit Automatic Test Settings .....	45
2.4.3 Adding a Step to the Automatic Test .....	45
2.4.4 Creating an AUTO Test File Name .....	46
2.4.5 Saving and Exiting EDIT Status .....	47
2.4.6 Automatic Test Page View .....	47
2.4.7 Running an Automatic Test .....	49
2.4.8 Automatic Test Results .....	52
2.5 Common Utility Settings .....	55
2.5.1 LCD Settings .....	55
2.5.2 Buzzer Settings .....	56
2.5.3 Interface Settings .....	57
2.5.4 Control Settings .....	58
3. EXTERNAL CONTROL .....	60
3.1 External Control Overview .....	60
3.1.1 Remote Terminal Overview .....	60
3.1.2 Remote Controller Operation .....	60
3.2 SIGNAL I/O Overview .....	61
3.2.1 Using the SIGNAL I/O to Start/Stop Tests .....	62
3.2.2 Using the Interlock Key .....	62
4. REMOTE CONTROL .....	64
4.1 Interface Configuration .....	64
4.1.1 USB Remote Interface .....	64
4.1.2 RS-232C Remote Interface .....	64
4.1.3 GP-IB Remote Interface .....	65
4.2 USB/RS-232C Remote Control Function Check .....	65
4.3 Return to Panel Control .....	66
4.4 Command Syntax .....	66
4.5 Command List .....	68
4.6 System Commands .....	70
4.6.1 SYSTem:LCD:CONTRast .....	70
4.6.2 SYSTem:LCD:BRIGHtness .....	70
4.6.3 SYSTem:BUZZer:PSOUND .....	70
4.6.4 SYSTem:BUZZer:FSOUND .....	70
4.6.5 SYSTem:BUZZer:PTIME .....	71
4.6.6 SYSTem:BUZZer:FTIME .....	71
4.6.7 SYSTem:ERRor .....	71
4.6.8 SYSTem:GPIB:VERSion .....	72
4.7 Function Commands .....	72
4.7.1 FUNCTion:TEST .....	72
4.7.2 MEASure<x> .....	72
4.7.3 MAIN:FUNCTion .....	73
4.8 Manual Commands .....	73
4.8.1 MANU:STEP .....	73
4.8.2 MANU:NAME .....	74

4.8.3	MANU:RTIME	74
4.8.4	MANU:EDIT:MODE	74
4.8.5	MANU:ACW:VOLTage	75
4.8.6	MANU:ACW:CHISet	75
4.8.7	MANU:ACW:CLOSet	75
4.8.8	MANU:ACW:TTime	76
4.8.9	MANU:ACW:FREQuency	76
4.8.10	MANU:ACW:REF	76
4.8.11	MANU:ACW:ARCCurrent	77
4.8.12	MANU:DCW:VOLTage	77
4.8.13	MANU:DCW:CHISet	77
4.8.14	MANU:DCW:CLOSet	78
4.8.15	MANU:DCW:TTime	78
4.8.16	MANU:DCW:REF	79
4.8.17	MANU:DCW:ARCCurrent	79
4.8.18	MANU:IR:VOLTage	79
4.8.19	MANU:IR:RHISet	80
4.8.20	MANU:IR:RLOSet	80
4.8.21	MANU:IR:TTime	80
4.8.22	MANU:IR:REF	80
4.8.23	MANU:GB:CURREnt	81
4.8.24	MANU:GB:RHISet	81
4.8.25	MANU:GB:RLOSet	81
4.8.26	MANU:GB:TTime	81
4.8.27	MANU:GB:FREQuency	82
4.8.28	MANU:GB:REF	82
4.8.29	MANU:GB:ZEROCHECK	82
4.8.30	MANU:UTILity:ARCMode	83
4.8.31	MANU:UTILity:PASShold	83
4.8.32	MANU:UTILity:FAILmode	83
4.8.33	MANU:UTILity:MAXHold	83
4.8.34	MANU:UTILity:GROUNDMODE	84
4.8.35	MANU<x>:EDIT:SHOW	84
4.9	Sweep Commands	84
4.9.1	SWEEP:DATA:STATus	84
4.9.2	SWEEP<X>:DATA:SHOW	85
4.9.3	SWEEP:GRAPh:SHOW	85
4.9.4	SWEEP :GRAPh:LINE	86
4.9.5	SWEEP:STARt:TIME	86
4.10	Auto Commands	86
4.10.1	AUTO:STEP	86
4.10.2	AUTO<x>:PAGE:SHOW	87
4.10.3	AUTO:PAGE:MOVE	87
4.10.4	AUTO:PAGE:SWAP	87
4.10.5	AUTO:PAGE:SKIP	88
4.10.6	AUTO:PAGE:DEL	88
4.10.7	AUTO:NAME	88

4.10.8 AUTO:EDIT:ADD .....	89
4.10.9 TESTok:RETurn.....	89
4.11 Common Commands .....	89
4.11.1 *CLS .....	89
4.11.2 *IDN .....	89
4.11.3 *RMTOFF.....	90
4.12 Error Messages .....	91
5. FAQ .....	92
5.1 The tester will not turn on.....	92
5.2 The panel keys are not working. ....	92
5.3 When I press the START button the tester will not start testing? ..	92
5.4 The accuracy does not match the specification.....	92
6. APPENDIX .....	93
6.1 Fuse Replacement .....	93
6.2 Error Messages .....	94
6.2.1 System Self-Test.....	94
6.2.2 Test Errors .....	94
6.3 STW-9000 Specifications .....	95
6.3.1 Specifications.....	95
6.4 Dimensions .....	100
6.4.1 STW-9801/9802/9803 Dimensions .....	100
6.4.2 STW-9901/9902/9903 Dimensions .....	101
6.4.3 STW-9904 Dimensions .....	102



# USING THE PRODUCT SAFELY

## ■ Preface

To use the product safely, read instruction manual to the end. Before using this product, understand how to correctly use it. If you read the manuals but you do not understand how to use it, ask us or your local dealer. After you read the manuals, save it so that you can read it anytime as required.

## ■ Pictorial indication

The manuals and product show the warning and caution items required to safely use the product. The following pictorial indication is provided.

Pictorial indication	
	Some part of this product or the manuals may show this pictorial indication. In this case, if the product is incorrectly used in that part, a serious danger may be brought about on the user's body or the product. To use the part with this pictorial indication, be sure to refer to the manuals.
 	If you use the product, ignoring this indication, you may get killed or seriously injured. This indication shows that the warning item to avoid the danger is provided.  If you incorrectly use the product, ignoring this indication, you may get slightly injured or the product may be damaged. This indication shows that the caution item to avoid the danger is provided.

Please be informed that we are not responsible for any damages to the user or to the third person, arising from malfunctions or other failures due to wrong use of the product or incorrect operation, except such responsibility for damages as required by law.

---

---

## USING THE PRODUCT SAFELY

---

---



### ■ Do not remove the product's covers and panels

Never remove the product's covers and panels for any purpose. Otherwise, the user's electric shock or fire may be incurred.

### ■ Warning on using the product

Warning items given below are to avoid danger to user's body and life and avoid the damage or deterioration of the product. Use the product, observing the following warning and caution items.

### ■ Warning items on power supply

#### ● Power supply voltage

The rated power supply voltages of the product are 100, 120, 220 and 240VAC. The rated power supply voltage for each product should be confirmed by reading the label attached on the back of the product or by the "rated" column shown in the instruction manual. The specification of power cord attached to the products is rated to 125VAC for all products which are designed to be used in the areas where commercial power supply voltage is not higher than 125VAC. Accordingly, you must change the power cord if you want to use the product at the power supply voltage higher than 125VAC. If you use the product without changing power cord to 250VAC rated one, electric shock or fire may be caused. When you used the product equipped with power supply voltage switching system, please refer to the corresponding chapter in the instruction manuals of each product.

#### ● Power cord

**(IMPORTANT) The attached power cord set can be used for this device only.**

If the attached power cord is damaged, stop using the product and call us or your local dealer. If the power cord is used without the damage being removed, an electric shock or fire may be caused.

#### ● Protective fuse

If an input protective fuse is blown, the product does not operate. For a product with external fuse holder, the fuse may be replaced. As for how to replace the fuse, refer to the corresponding chapter in the instruction manual. If no fuse replacement procedures are indicated, the user is not permitted to replace it. In such case, keep the case closed and consult us or your local dealer. If the fuse is incorrectly replaced, a fire may occur.



---

---

## USING THE PRODUCT SAFELY

---

---

### ■ Warning item on Grounding

If the product has the GND terminal on the front or rear panel surface, be sure to ground the product to safely use it.

### ■ Warnings on Installation environment

#### ● Operating temperature and humidity

Use the product within the operating temperature indicated in the “rating” temperature column. If the product is used with the vents of the product blocked or in high ambient temperatures, a fire may occur. Use the product within the operating humidity indicated in the “rating” humidity column. Watch out for condensation by a sharp humidity change such as transfer to a room with a different humidity. Also, do not operate the product with wet hands. Otherwise, an electric shock or fire may occur.

#### ● Use in gas

Use in and around a place where an inflammable or explosive gas or steam is generated or stored may result in an explosion and fire. Do not operate the product in such an environment. Also, use in and around a place where a corrosive gas is generated or spreading causes a serious damage to the product. Do not operate the product in such an environment.

#### ● Installation place

Do not insert metal and inflammable materials into the product from its vent and spill water on it. Otherwise, electric shock or fire may occur.

### ■ Do not let foreign matter in

Do not insert metal and inflammable materials into the product from its vent and spill water on it. Otherwise, electric shock or fire may occur.

### ■ Warning item on abnormality while in use

If smoke or fire is generated from the product while in use, stop using the product, turn off the switch, and remove the power cord plug from the outlet. After confirming that no other devices catch fire, ask us or your local dealer.

---

---

## USING THE PRODUCT SAFELY

---

---

### ■ Input / Output terminals

Maximum input to terminal is specified to prevent the product from being damaged. Do not supply input, exceeding the specifications that are indicated in the "Rating" column in the instruction manual of the product. Also, do not supply power to the output terminals from the outside. Otherwise, a product failure is caused.

### ■ Calibration

Although the performance and specifications of the product are checked under strict quality control during shipment from the factory, they may be deviated more or less by deterioration of parts due to their aging or others.

It is recommended to periodically calibrate the product so that it is used with its performance and specifications stable. For consultation about the product calibration, ask us or your local dealer.

### ■ Daily Maintenance

When you clean off the dirt of the product covers, panels, and knobs, avoid solvents such as thinner and benzene. Otherwise, the paint may peel off or resin surface may be affected. To wipe off the covers, panels, and knobs, use a soft cloth with neutral detergent in it.

During cleaning, be careful that water, detergents, or other foreign matters do not get into the product.

If a liquid or metal gets into the product, an electric shock and fire are caused.

During cleaning, remove the power cord plug from the outlet.

Use the product correctly and safely, observing the above warning and caution items. Because the instruction manual indicates caution items even in individual items, observe those caution items to correctly use the product.

If you have questions or comments about the manuals, ask us or E-Mail us.

# 1. GETING STARTED

This chapter describes the safety tester in a nutshell, including its main features and front / rear panel introduction. After going through the overview, please read the safety considerations in the Set Up chapter.



## 1.1 STW-9000 Series Overview

---

The STW-9000 Series Safety Testers are AC/DC withstanding voltage, insulation resistance and ground bond safety testers.

The STW-9901/9801 are AC withstanding voltage testers, the STW-9902/9802 are AC/DC withstanding voltage testers and the STW-9903/9803 are AC/DC withstanding voltage and insulation resistance testers. The STW-9904 includes all the test functions of the other models as well as ground bond testing. All models can operate at up to 5kVAC for AC withstanding voltage testing and at up to 6kVDC for DC withstanding voltage testing (excluding the STW-9901/9801).

For the STW-9000 models, the testing terminals are also mirrored on the rear panel for added safety and for more permanent safety testing environments. They also include an innovative sweep function to view test results as a graph.

The STW-9000 Series can store up to 100 manual tests, as well as run up to 16 manual tests sequentially as an automatic test, allowing the safety testers to accommodate any number of safety standards, including IEC, EN, UL, CSA, GB, JIS and others.

Note: Throughout this user manual, the terms ACW, DCW, IR and GB refer to AC Withstanding, DC Withstanding, Insulation Resistance and Ground Bond testing, respectively.

## 1.2 Model Overview

Model name	ACW	DCW	IR	GB	Sweep	Rated Load
STW-9901	✓				✓	500VA/100W
STW-9902	✓	✓			✓	500VA/100W
STW-9903	✓	✓	✓		✓	500VA/100W
STW-9904	✓	✓	✓	✓	✓	500VA/100W
STW-9801	✓					200VA/50W
STW-9802	✓	✓				200VA/50W
STW-9803	✓	✓	✓			200VA/50W

## 1.3 Main Features

Performance	<ul style="list-style-type: none"> <li>• ACW: 5kVAC</li> <li>• DCW: 6kVDC</li> <li>• IR: 50V~1000V (50V steps)</li> <li>• GB: 3A~32A (STW-9904)</li> </ul>
Features	<ul style="list-style-type: none"> <li>• Ramp up time control</li> <li>• Safety discharge</li> <li>• 100 test conditions (MANU mode)</li> <li>• 100 automatic tests (AUTO mode)</li> <li>• Over temperature, voltage and current protection</li> <li>• Pass, Fail, Test, High Voltage and Ready indicators</li> <li>• PWM output (90% efficiency, increased reliability)</li> <li>• Interlock (configurable).</li> <li>• Sweep Function.</li> </ul>
Interface	<ul style="list-style-type: none"> <li>• Remote control start/stop interface terminal</li> <li>• RS-232C/USB interface for programming</li> <li>• Optional GP-IB interface for programming</li> <li>• Signal I/O port for pass/fail/test monitoring and start/stop control/interlock</li> </ul>

## 1.4 Accessories

Standard Accessories	Part number	Description
	GHT-114	Test lead
	Power cord	Region dependent
	GTL-115	GB Test leads (STW-9904 only)
	N/A	Remote terminal male plug
	N/A	Interlock key
	N/A	Accessories CD (Instruction manual, USB Driver)

Optional Accessories	Part number	Description
	GHT-205	High Voltage Test Probe
	GHT-113	High Voltage Test Pistol
	GTL-232	RS-232C cable
	GTL-248	GP-IB cable
	GTL-247	USB cable(A-A)
	GRA-417	Rack Adapter Panel (19",4U) (STW-9901/02/03/9801/9802/9803)
Options	Part number	Description
	Opt.1 GP-IB Interface	GP-IB module

## 1.5 Package Contents

Check the contents before using the STW-9000.

### Opening the box

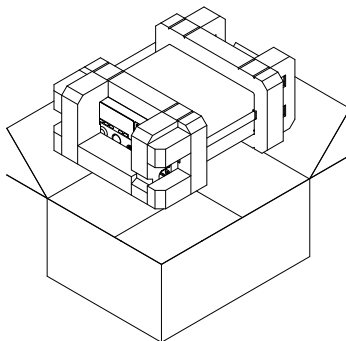

Contents (single unit)	<ul style="list-style-type: none"> <li>• STW-9000 unit</li> <li>• Accessories CD (Instruction manual, USB Driver)</li> <li>• Power cord x1 (region dependent)</li> <li>• GHT-114 test leads x1</li> <li>• GTL-115 test leads x1(STW-9904)</li> <li>• Remote terminal male plug</li> <li>• Interlock key</li> </ul>
---------------------------	--



Note

Keep the packaging, including the box, polystyrene foam and plastic envelopes should the need arise to return the unit to TEXIO TECHNOLOGY.





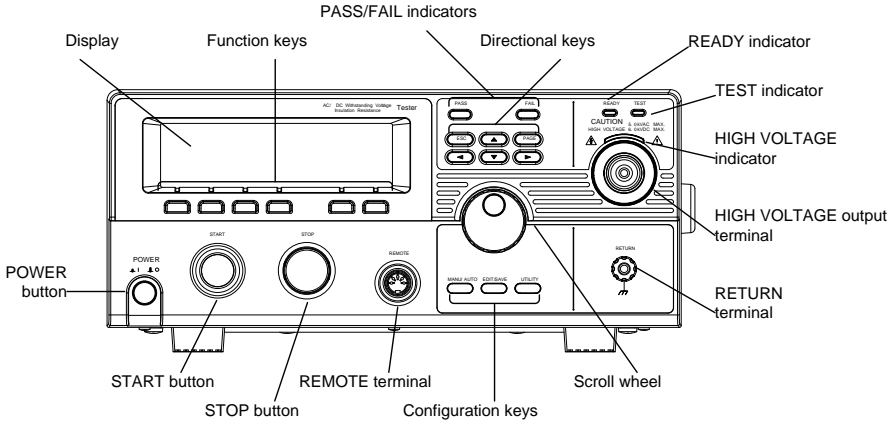

# 1.6 Appearance

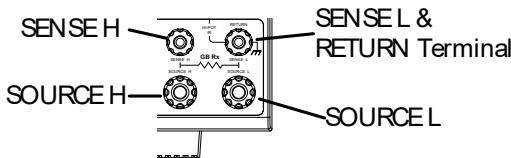
## 1.6.1 STW-9000 Front Panel



## 1.6.2 STW-9904 Front Panel

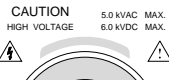

Display	240 X 64 dot matrix display (LCD)	
Function keys	The function keys correspond to the soft-keys directly above on the main display.	
Pass/Fail indicators		The PASS and FAIL indicators light up upon a PASS or FAIL test result at the end of a manual test or automatic test.
ESC key		The ESC key is used to exit out of a menu or cancel a setting.
PAGE key		The PAGE key is used to view automatic test information and test results.
Directional arrow keys		The directional arrow keys are used to navigate menus and parameter settings.
READY indicator		The READY indicator is lit when the tester is ready to begin testing. The STOP button is used to put the tester into READY status.
TEST indicator		The TEST indicator is lit when a test is on. The START button is used to put the tester into TEST status.
HIGH VOLTAGE indicator		The HIGH VOLTAGE indicator will light up when an output terminal is active. Only after the test has finished or stopped will the indicator turn off.

HIGH VOLTAGE output terminal

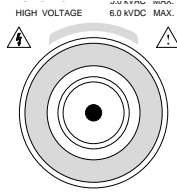

The HIGH VOLTAGE terminal output is used for outputting the testing voltage. The terminal is recessed for safety. This terminal is used in conjunction with the RETURN terminal.



WARNING

USE EXTREME CAUTION.

Do not touch the HIGH VOLTAGE terminal during testing.

RETURN terminal

Except STW-9904 RETURN

The RETURN terminal is used for IR, DCW and ACW tests.

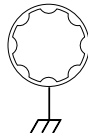

RETURN, SENSE and SOURCE terminals

Only STW-9904

The RETURN terminal is used for IR, DCW and ACW tests. The SOURCE H, SOURCE L, SENSE H and SENSE L terminals are used for GB tests.

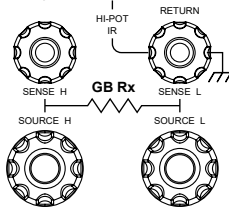

Scroll wheel

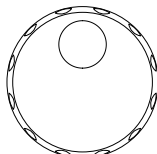

The scroll wheel is used to edit parameter values.

UTILITY key

UTILITY

Used to enter the MANU Utility or Common Utility menu.



EDIT/SAVE key

EDIT/SAVE

Used to start editing MANU/AUTO tests as well as save settings and parameters.



MANU/AUTO key

MANU/AUTO

The MANU/AUTO key is used to select manual tests (MANU) or automatic tests (AUTO).



REMOTE terminal

REMOTE

The REMOTE terminal is used to connect to a remote controller.



STOP button

STOP

The STOP button is used to stop/cancel tests. The STOP button will also put the safety tester in the READY status to begin testing.

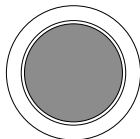

START button

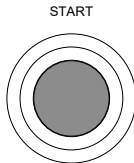

The START button is used to start tests. The START button can be used to start tests when the tester is in the READY status. Pressing the START button will put the tester in the TEST status.

POWER switch

POWER

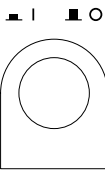

Turns the power on. The safety tester will always start up with the last test setting from when the instrument was last powered down.

### 1.6.3 STW-9901/9902/9903 Rear Panel

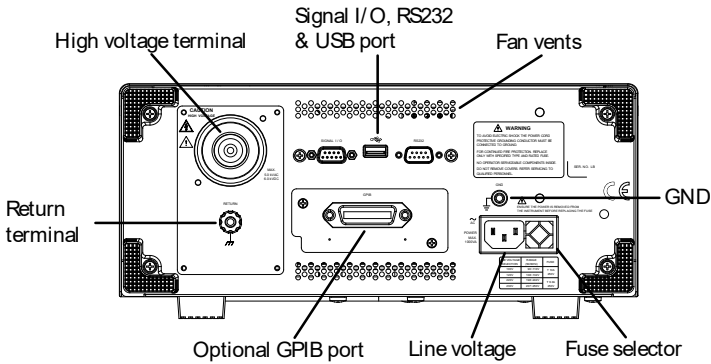

### 1.6.4 STW-9904 Rear Panel

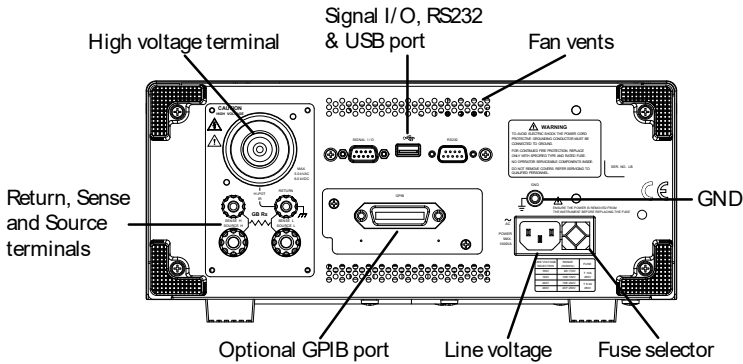



### 1.6.5 STW-9801/9802/9803 Rear Panel

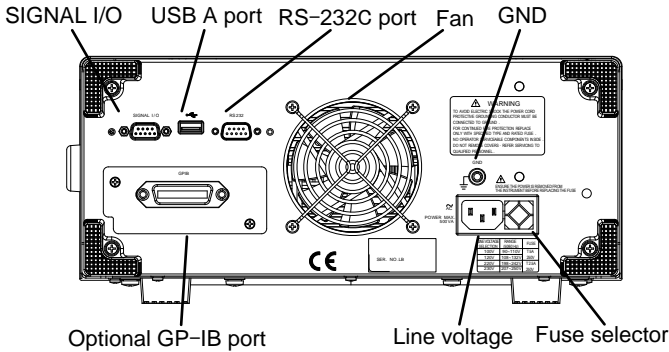

SIGNAL I/O port

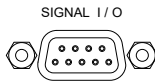

The SIGNAL I/O port is used to monitor the tester status (PASS, FAIL, TEST) and input (START/ STOP signals). It is also used with the Interlock key.

USB A port



Used for remote control.

RS-232C interface port

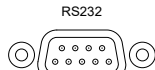

Used for remote control and firmware updates.

Fan/Fan Vents



Exhaust fan. Allow enough room for the fan to vent. Do not block the fan openings.

GND

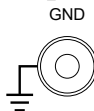

Connect the GND (ground) terminal to the earth ground.

Line voltage input

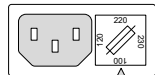

Line voltage input: 100/120/220/230VAC  $\pm 10\%$

Line voltage fuse

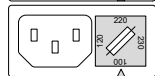

Line voltage selector and fuse:

	STW-9900	STW-9800
100V/120V	T10A 250V	T5A 250V
220V/230V	T6.3A 250V	T2.5A 250V

Optional GP-IB port

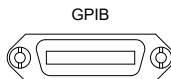

Optional GP-IB interface for remote control.

HIGH VOLTAGE output terminal

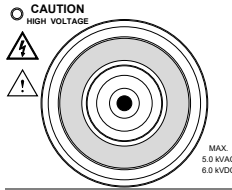

The HIGH VOLTAGE terminal output is used for outputting the testing voltage.



**WARNING**  
RETURN terminal

**USE EXTREME CAUTION.**

Do not touch the HIGH VOLTAGE terminal during testing.

STW-9901/9902/9903

RETURN

The RETURN terminal is used for IR, DCW and ACW tests.

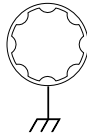

RETURN/  
SENSE and  
SOURCE  
terminals

Only STW-9904

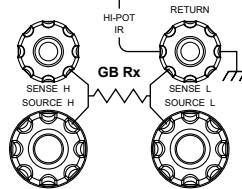

The RETURN terminal is used for IR, DCW and ACW tests.  
The SOURCE L/H AND SENSE L/H terminals are for GB tests only.

## 1.7 Set Up

### 1.7.1 Line Voltage Connection and Power Up

Background

Before powering up the STW-9000 ensure the correct voltage has been selected on the rear panel. The STW-9000 supports line voltages of 100V/120V/220V and 230V.

Steps

1. Check the line voltage and the fuse in the fuse holder.  
The desired line voltage should line up with the arrow on the fuse holder.

Page 93

2. Connect the power cord to the AC voltage input.

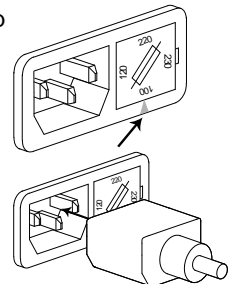

- If the power cord does not have an earth ground, ensure the ground terminal is connected to an earth ground.

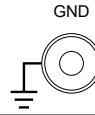

Warning

Ensure the power cord is connected to an earth ground. Failure could be harmful to the operator and instrument.

- Press the Power button.

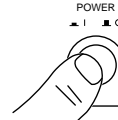

- When the unit is powering up, all the LED indicators will light. Check to make sure all 5 LED indicators are working.
- Check to make sure the System Self-Test passes without errors.



After the System Self-Test completes, the tester will go into VIEW status and be ready to operate.

VIEW status

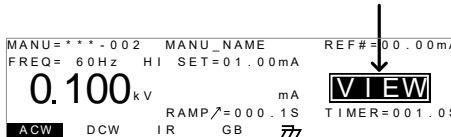

WARNING

See the Appendix on page 94 for details if a self-test error is detected.

## 1.7.2 Installing the Optional GP-IB Card

Background

The optional GP-IB is a user-installable option. Follow the instructions below to install the GP-IB card.



WARNING

Before installing the optional GP-IB card ensure the STW-9000 is turned off and disconnected from power.

Steps

- Remove the screws from the rear panel cover plate.

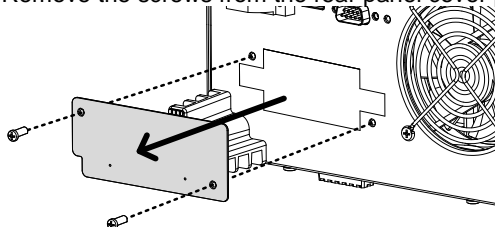

2. Insert the GP-IB card into the two slots on either side of the opening. Push the card gently until it is fully inserted.

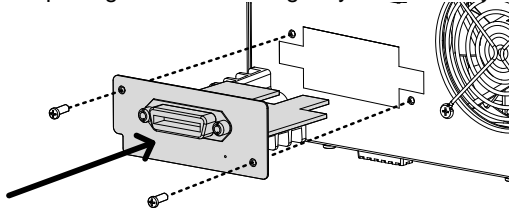

### 1.7.3 Workplace Precautions

#### Background

The STW-9000 is a high voltage instrument that outputs dangerous voltages. The following section describes precautions and procedures that must be followed to ensure a safe work environment.



#### WARNING

The STW-9000 generates voltages in excess of 5kVAC or 6kVDC. Follow all safety precautions, warnings and directions given in the following section when using the instrument.

1. Only technically qualified personnel should be allowed to operate the safety tester.
2. The operating workplace must be fully isolated, especially when the instrument is in operation. The instrument should be clearly labeled with appropriate warning signage.
3. The operator should not wear any conductive materials, jewelry, badges, or other items, such as wrist watches.
4. The operator should wear insulation gloves for high voltage protection.
5. Ensure the earth ground of the line voltage is properly grounded.
6. Ensure any devices that are adversely affected by magnetic fields are not placed near the tester.

## 1.7.4 Operating Precautions

---

### Background

The STW-9000 is a high voltage instrument that outputs dangerous voltages. The following section describes precautions and procedures that must be followed to ensure that the tester is operated in a safe manner.

---



### WARNING

The STW-9000 generates voltages of up to 5kVAC or 6kVDC. Follow all safety precautions, warnings and directions given in the following section when using the instrument.

---

1. Never touch the safety tester, lead wires, terminals, probes and other connected equipment when the tester is testing.
2. Do not turn the safety tester on and off quickly or repeatedly. When turning the power off, please allow a few moments before turning the power back on. This will allow the protection circuits to properly initialize.  
Do not turn the power off when a test is running, unless in an emergency.
3. Only use those test leads supplied with the instrument. Leads with inappropriate gauges can be dangerous to both the operator and the instrument.  
For GB testing, never use the Sense leads on the SOURCE terminals.
4. Do not short the HIGH VOLTAGE terminal with ground. Doing so could charge the chassis to dangerously high voltages.
5. Ensure the earth ground of the line voltage is properly grounded.
6. Only connect the test leads to the HIGH VOLTAGE/SOURCE H/SENSE H terminals before the start of a test. Keep the test leads disconnected at all other times.
7. Always press the STOP button when pausing testing.
8. Do not leave the safety tester unattended. Always turn the power off when leaving the testing area.
9. When remotely controlling the safety tester, ensure adequate safety measures are in place to prevent:
  - Inadvertent output of the test voltage.
  - Accidental contact with the instrument during testing. Ensure that the instrument and DUT are fully isolated when the instrument is remotely controlled.

10. Ensure an adequate discharge time for the DUT.  
 When DCW or IR tests are performed, the DUT, test leads and probes become highly charged. The STW-9000 has discharge circuitry to discharge the DUT after each test. The time required for a DUT to discharge depends on the DUT and test voltage.  
 Never disconnect the safety tester before a discharge is completed.

### 1.7.5 Basic Safety Checks

---

Background	The STW-9000 is a high voltage device and as such, daily safety checks should be made to ensure safe operation.
	<ol style="list-style-type: none"> <li>1. Ensure all test leads are not broken and are free from defects such as cracks or splitting.</li> <li>2. Ensure the safety tester is always connected to an earth ground.</li> <li>3. Test the safety tester operation with a low voltage/current output:            Ensure the safety tester generates a FAIL judgment when the HIGH VOLTAGE and RETURN terminals are shorted (using the lowest voltage/current as the testing parameters).</li> </ol>



**WARNING**

Do not use high voltages/currents when the HIGH VOLTAGE and RETURN terminals are shorted. It may result in damage to the instrument.

---

## 2. OPERATION

### 2.1 Menu Tree

This section describes the overall structure of the operation statuses and modes for the STW-9000 safety testers. The testers have two main testing modes (MANU, AUTO) and 5 main operation statuses (VIEW, EDIT, READY, TEST and STOP).

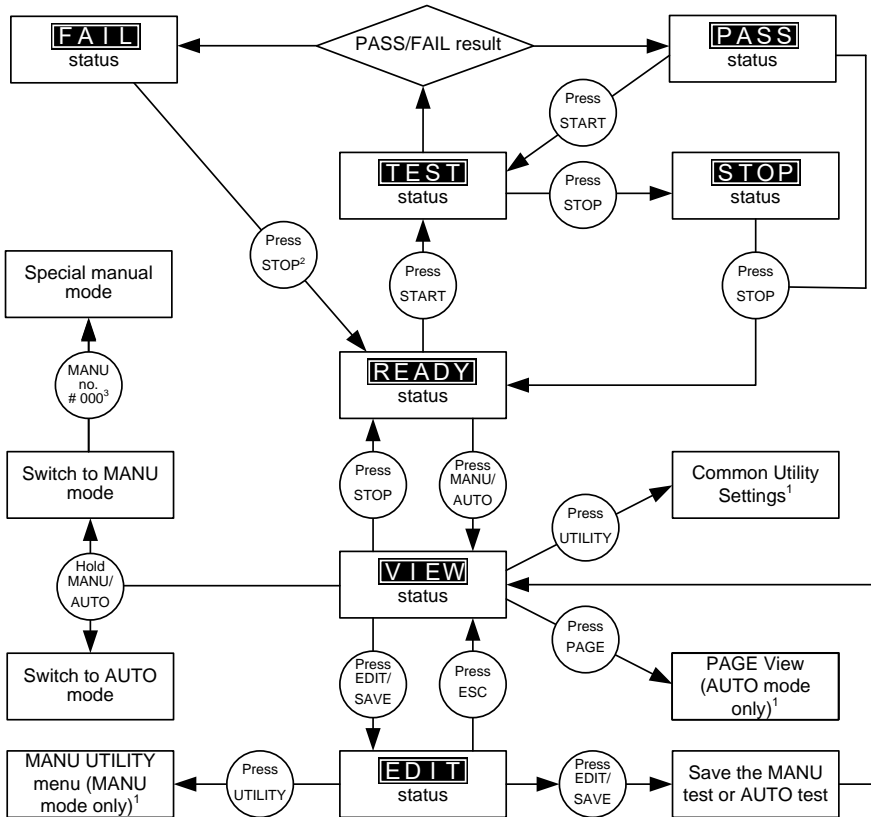

<sup>1</sup> Press EDIT/SAVE to save settings, or ESC to cancel and return to the previous screen.

<sup>2</sup> Press the STOP key twice for a FAIL result.

<sup>3</sup> When in MANU mode, selecting MANU number 000 will enter the special manual mode.

<sup>4</sup> The Sweep mode function is only accessible in the special manual mode.

## 2.1.1 Menu Tree Overview

### VIEW status

VIEW status is used to view the parameters of the selected manual test/automatic test. The VIEW status is also used to put the tester into MANU or AUTO mode.

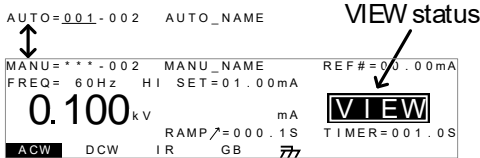

### EDIT status

EDIT status is used to edit the manual test or automatic test parameters. Pressing the EDIT/SAVE key will save any changes. Pressing the ESC key will cancel any changes.

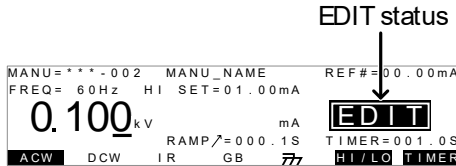

### READY status

When the tester is in READY status, it is ready to begin testing. Pressing the START button will begin testing and put the tester into TEST status. Pressing the MANU/AUTO key will return the tester to VIEW status.

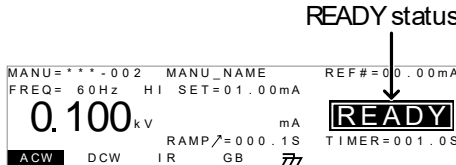

### TEST status

TEST status is active when a MANU test or AUTO test is running. Pressing STOP will cancel the MANU test or the remaining steps in an AUTO test.

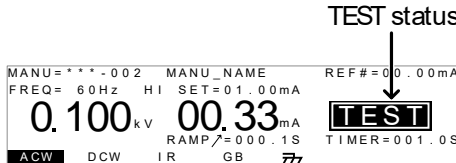



STOP status

STOP status is shown when a manual test or automatic test did not finish running and has been stopped by the operator. Pressing STOP will return the tester to READY status.

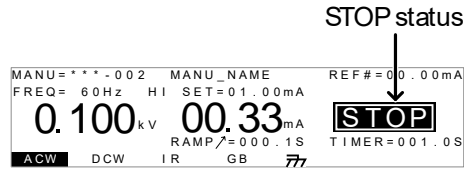

Page View

Up to 16 tests can be used to create an automatic test. Page View is used to see which manual tests (steps) an automatic test is composed of. The steps can be re-arranged and deleted in Page View.

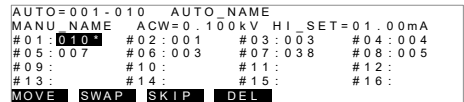

AUTO mode

AUTO indicates that the tester is in AUTO mode. AUTO mode is for creating/running a sequence of up to 16 MANU tests.

AUTO mode

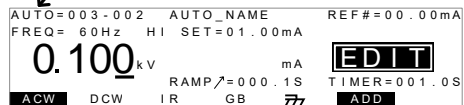

MANU mode

MANU mode is used to create and/or execute a single test. MANU indicates that the manual test mode is active.

MANU mode

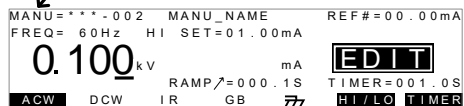

Common Utility Settings

This utility controls the LCD, buzzer, interface and control settings. These settings are system wide.

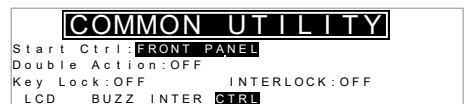

## MANU Utility Settings

The Manu Utility settings are configured for each MANU test separately. The settings include: ARC MODE, PASS HOLD, FAIL MODE, MAX HOLD and GROUND MODE.

```
MANU=***-002  MANU UTILITY
ARC  MODE:OFF
PASS HOLD:OFF
FAIL  MODE:STOP
MAX  HOLD:OFF
GROUND MODE:ON
```

## 2.2 Test Lead Connection

This section describes how to connect the STW-9000 to a DUT for withstanding, insulation resistance or ground bond testing.

### 2.2.1 ACW, DCW, IR Connection

---

**Background** ACW, DCW and IR tests use the HIGH VOLTAGE terminal and RETURN terminal with the GHT-114 test leads.

---

**ACW, DCW, IR Connection**

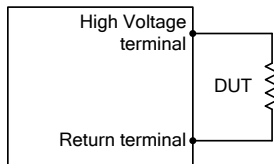

**Steps**

1. Turn the power off on the safety tester.
2. Connect the high voltage test lead (red) to the HIGH VOLTAGE terminal and screw firmly into place.
3. Connect the return test lead (white) into the RETURN terminal and screw the protector bar into place, as shown below.

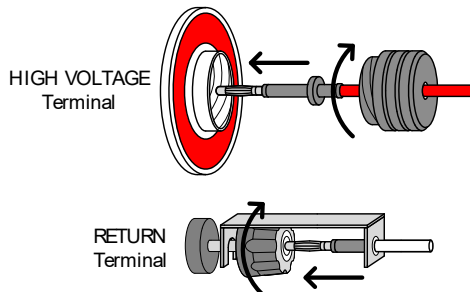

## 2.2.2 GB Connection

**Background** GB tests use the SENSE H/L and SOURCE H/L terminals with the GTL-115 test leads.

**GB Connection**

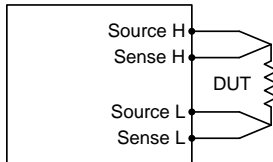

**Steps**

1. Turn the power off on the safety tester.
2. Connect the Sense H lead to the SENSE H terminal.
3. Connect the Sense L lead to the SENSE L terminal.
4. Connect the Source H lead to the SOURCE H terminal.
5. Connect the Source L lead to the SOURCE L terminal.

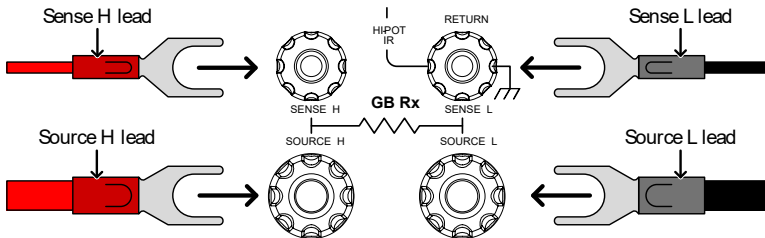

## 2.3 ACW, DCW and GB Manual Testing

This section describes how to create, edit and run a *single* ACW, DCW, IR or GB safety test. Each Manual setting described in this chapter *only applies to the selected manual test – no other manual tests are affected.*

Each manual test can be stored/recalled to/from one of 100 memory locations. Each stored manual test can be used as a test step when creating an AUTO test (page 44).

Before operating the STW-9000 please read the safety precautions as outlined in the Set Up chapter on page 8.

### 2.3.1 Choose/Recall a Manual Test Number

#### Background

ACW, DCW, IR and GB tests can only be created in the MANU (manual) mode. MANU number 001 to 100 can be saved and thus be loaded when editing/creating a MANU test or AUTO test. MANU number 000 is a special mode. See page 39 for details on the special mode.

#### Steps

1. If the tester is in AUTO mode, press and hold the MANU/AUTO key for three seconds to switch to MANU mode.  
The tester can only switch between AUTO and MANU mode when in the VIEW status.

MANU/AUTO

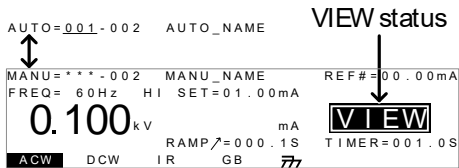

2. Use the scroll wheel to choose the MANU number.

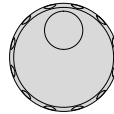

MANU # 001~100  
(MANU# 000 is a special mode)

MANU number

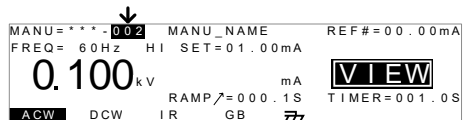

Note

The MANU number can only be chosen in VIEW status. If in the EDIT status, switch to the VIEW status by pressing the EDIT/SAVE or ESC key.

### 2.3.2 Edit Manual Test Settings

#### Background

To edit any of the manual test settings, the tester must be in EDIT status.  
Any settings or parameters that are edited only apply to the currently selected MANU number.

#### Steps

1. Press the EDIT/SAVE key when in VIEW status to enter the EDIT status. This will enter the EDIT status for the chosen test number.

EDIT/SAVE



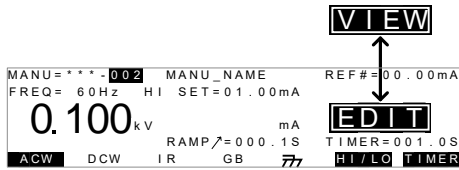

- The Status changes from VIEW to EDIT.



Note

Pressing the EDIT/SAVE key again will save the settings for the current test and return back to VIEW status.

### 2.3.3 Setting the Test Function

Background

After a MANU number has been chosen and the tester is in EDIT status, a test function can be set. There are four test functions, AC Withstand, DC Withstand, Insulation Resistance and Ground Bond.

Steps

- To choose the test function, press the ACW, DCW, IR or GB soft-keys.



- The test function soft-key is highlighted.

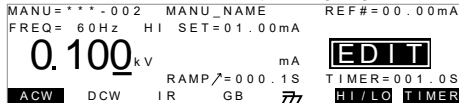

test function



Note

The chosen test function only applies to the current test.

### 2.3.4 Setting the Test Voltage or Test Current

Background

The test voltage can be set from 0.100kV to 5kV for ACW, 0.100kV to 6kV for DCW and 0.050 to 1kV for IR (50V steps). For GB tests the test current can be set from 3A to 32A.

Steps

- Press the UP / DOWN arrow keys to bring the cursor to the voltage setting.

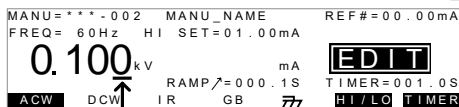

cursor

- Use the scroll wheel to set the voltage level.

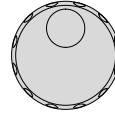

ACW	0.100kV ~ 5kV
DCW	0.100kV ~ 6kV
IR	0.05kV ~ 1kV (50V steps)
GB	3.00A~ 32.00A (STW-9904)



Note

When setting the voltage for STW-9900, be aware that a maximum of 500VA can be set for ACW and 100W for DCW, or for STW-9800, be aware that a maximum of 200VA can be set for ACW and 50W for DCW. The ground bond voltage (GBV) is calculated as the HI SET limit x Test Current.

### 2.3.5 Setting the Test Frequency

**Background** A test frequency of 60Hz or 50Hz can be set, regardless of the input line voltage. The test frequency setting only applies to ACW and GB tests.

- Press the UP / DOWN arrow keys to bring the cursor to the FREQ setting.

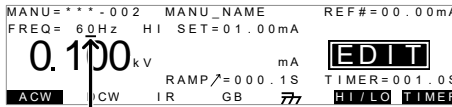

cursor

- Use the scroll wheel to set the test frequency.

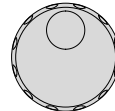

ACW, GB 50Hz, 60Hz



Note

The test frequency can only be set for ACW or GB tests.

### 2.3.6 Setting the Upper and Lower Limits

**Background** There is both a LO and HI judgment setting. When the measured value is below the LO SET setting, the test will be judged as FAIL. When the value exceeds the HI SET setting the test will be judged as FAIL. Any measurement between the LO SET and HI SET setting is judged as PASS. The LO SET limit cannot be made greater than the HI SET limit.

Steps

1. Press the HI/LO soft-key or use the UP / DOWN arrow keys to bring the cursor to the HI SET (ACW/DCW/GB) setting or the LO SET (IR) setting.

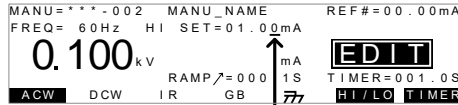
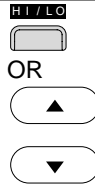

cursor

2. Use the scroll wheel to set the HI SET/LO SET limit.

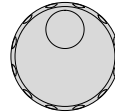

HI SET	STW-9900	STW-9800
ACW (HI)	0.001mA~110.0mA	0.001mA~042.0mA
DCW (HI)	0.001mA~021.0mA	0.001mA~011.0mA
IR (LO)	0.001GΩ ~ 50.00GΩ	0001MΩ ~ 9999MΩ
GB (HI)	000.1mΩ ~ 650.0mΩ	-

3. Press the HI/LO soft-key again or press the DOWN arrow key to switch between HI SET and LO SET.

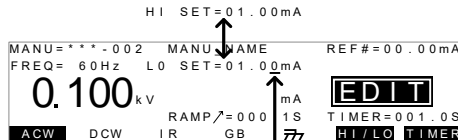
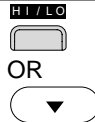

cursor

4. Use the scroll wheel to set the HI SET/LO SET limit.

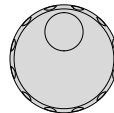

LO SET	STW-9900	STW-9800
ACW (LO)	0.000mA~109.9mA	0.001mA~042.0mA
DCW (LO)	0.000mA~020.9mA	0.001mA~011.0mA
IR (HI)	0.001GΩ~50.00GΩ	0001MΩ ~ 9999MΩ
GB (LO)	000.0mΩ ~ 649.9mΩ	-



Note

The LO SET setting is limited by the HI SET setting. The LO SET limit cannot be greater than the HI SET limit. When setting the current, be aware that a maximum of 500VA can be set for ACW and 100W for DCW.

### 2.3.7 Setting a Reference Value

**Background** The REF# acts as an offset. The REF# value is subtracted from the measured current (ACW, DCW) or measured resistance (IR, GB).

**Steps** 1. Press the UP / DOWN arrow keys to bring the cursor to the REF# setting.



cursor

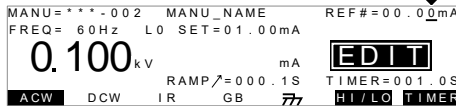

2. Use the scroll wheel to set the REF# value.

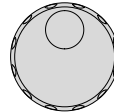

ACW 0.000mA~HI SET current-0.1mA  
 DCW 0.000mA~HI SET current-0.1mA  
 IR 0000MΩ~HI SETΩ-1MΩ  
 GB 000.0mΩ~HI SETΩ-0.1mΩ



Note

For GB tests, a reference offset can be automatically created using the zeroing function. See page 39 for details.

### 2.3.8 Setting the Test Time (Timer)

**Background** The TIMER setting is used to set the test time for the current test. The test time determines how long the test voltage or current is applied to the DUT. This test time does not include Ramp^, initial start time or discharge time (note: GB does not have Ramp^ or discharge times). The test time can be set from 0.5 seconds to 999.9 seconds for ACW, DCW and GB and 1.0 second to 999.9 seconds for IR, with a resolution of 0.1 seconds for all modes. The timer can be turned off when in the special MANU test mode when using the ACW or DCW test functions.

Each test has an initial test time of approximately 150ms and a discharge time (except GB). The total discharge time depends on the DUT and test voltage.



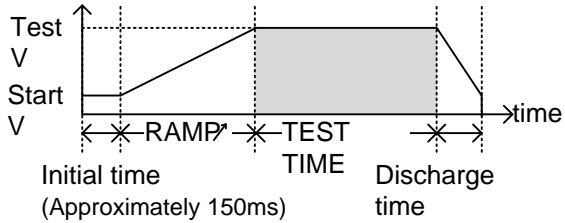

Steps

1. Press the **TIMER** soft-key or use the UP/DOWN arrow keys to bring the cursor to the **TIMER** setting.

**TIMER**



OR

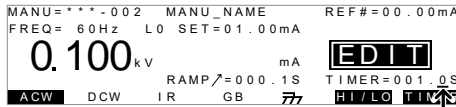

cursor

2. Use the scroll wheel to set the **TIMER** value.

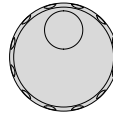

ACW	000.5s~999.9s
DCW	000.5s~999.9s
IR	001.0s~999.9s
GB	000.5s~999.9s



Note

With the ACW test function, when the test current is between 80mA and 100mA, the ramp time + test time cannot exceed 240 seconds. At this current level, the tester also needs to pause after a test for a time equal to or greater than the output time. See the specifications on page 95 for details.

Special Manual Mode

When in special MANU test mode (page 39) the Timer can be turned off when using the DCW or ACW test function. Hold the **TIMER** soft-key for 3 seconds to turn the timer off.

**TIMER**



Note

The timer can only be turned off under special MANU test mode, however there is a limitation: The timer cannot be turned off (limited to 240s) if the test current is between 80mA and 100mA in ACW mode. The discharge time and initial test time cannot be edited.

### 2.3.9 Setting the Ramp Up Time

#### Background

The Ramp Up time is the total time taken for the tester to reach the test voltage level. The Ramp Up time starts after the initial time (approximately 150ms) with a start voltage of 50 volts. The Ramp Up time can be set from 000.1 to 999.9 seconds. The Ramp Up time is only applicable for ACW, DCW and IR tests.

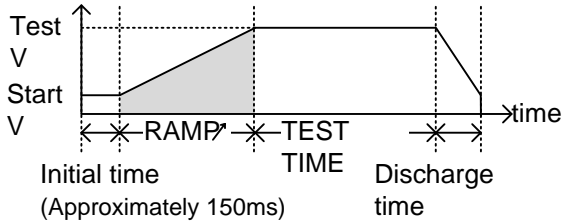

#### Steps

1. Use the UP/DOWN arrow keys to bring the cursor to the RAMP ↗ setting.

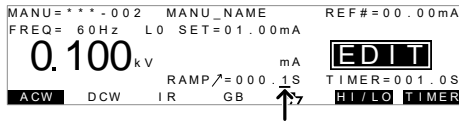

cursor

2. Use the scroll wheel to set the RAMP ↗ value.

ACW            000.1s~999.9s  
 DCW           000.1s~999.9s  
 IR             000.1s~999.9s

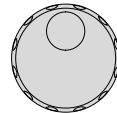

Note

The discharge time and initial test time cannot be edited.

### 2.3.10 Creating a MANU Test File Name



#### Background

Each manual test can have a user-defined test file name (default: MANU\_NAME) up to 10 characters long. See the character list below for the allowed characters.



Character List

0	1	2	3	4	5	6	7	8	9																
A	B	C	D	E	F	G	H	I	J	K	L	M	N	O	P	Q	R	S	T	U	V	W	X	Y	Z
a	b	c	d	e	f	g	h	i	j	k	l	m	n	o	p	q	r	s	t	u	v	w	x	y	z
+	-	*	/	_	=	:	Ω	?	(	)	<	>	[	]											

Steps

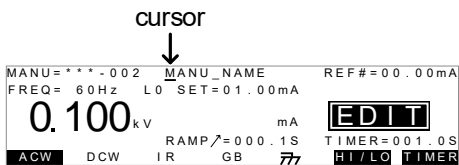
1. Use the UP/DOWN arrow keys to bring the cursor to the MANU test file name at the top of the screen. The test file name is initially set as MANU\_NAME.  

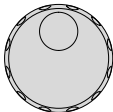

2. Use the scroll wheel to scroll through the available characters. 
3. Press the Left/Right arrow keys to go the next character.  
4. The MANU test file name is set when the current test setting is saved or when the cursor is moved to another setting.

### 2.3.11 Setting the ARC Mode

Background

ARC detection, otherwise known as flashover detection, detects fast voltage or current transients that are not normally detected. Arcing is usually an indicator of poor withstanding insulation, electrode gaps or other insulating problems that cause temporary spikes in current or voltage during ACW and DCW testing. There are three ARC detection settings: OFF, ON AND CONTINUE, ON AND STOP. The ON AND CONTINUE setting will detect arcs over the ARC current level and continue the test, the ON AND STOP setting will stop the test when an arc is detected. ARC mode settings only apply to ACW and DCW tests.

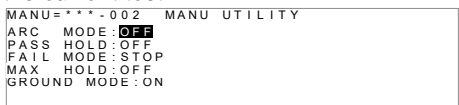

Steps

1. Press the UTILITY key on the front panel when the tester is in EDIT status.  The tester will go to the MANU Utility for the *current test*.



Note

The MANU UTILITY settings only apply to the selected MANU test.

2. Use the UP/DOWN arrow keys to move to the ARC MODE setting.  

- Use the scroll wheel to set the ARC mode.

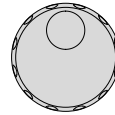

ARC MODES: OFF, ON AND CONTINUE,  
ON AND STOP

- Press the EDIT/SAVE key to save and exit the MANU Utility and go back to EDIT status.

EDIT/SAVE



Note

The ESC key can be pressed at any time in the Utility menu to cancel and exit.

- If the ARC MODE was set to either ON AND CONTINUE, or ON AND STOP, the ARC current level can be edited.
- Use the UP/DOWN arrow keys to move the cursor to the ARC setting.



- Use the scroll wheel to edit the ARC level.

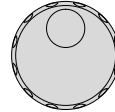

ACW	2.000mA~200.0mA
DCW	2.000mA~040.0mA



Note

The ARC setting range is directly related to the HI SET current limit.

ACW:

HI SET Limit	ARC Range
0.001mA~1.100mA	2.000mA
01.11mA~11.00mA	02.00mA ~20.00mA
011.1mA~110.0mA	002.0mA ~200.0mA

DCW:

HI SET Limit	ARC Range
0.001mA~1.100mA	2.000mA
01.11mA~11.00mA	02.00mA ~20.00mA
011.1mA~021.0mA	002.0mA ~040.0mA

### 2.3.12 Setting PASS HOLD







Background

The PASS HOLD settings only apply to the selected test in an AUTO test. When the PASS HOLD setting is set to ON, a PASS judgment is held until the START button is pressed.

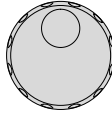

Note

The PASS HOLD setting only applies to AUTO tests. This setting is ignored when running a *single* MANU test.

Steps	<ol style="list-style-type: none"> <li>1. Press the UTILITY key on the front panel when the tester is in EDIT status. The display will go from the normal EDIT status to the MANU Utility menu for <i>the current test</i>.</li> </ol>	
 Note	<p>The MANU UTILITY settings only apply to the selected MANU test.</p> <ol style="list-style-type: none"> <li>2. Use the UP/DOWN arrow keys to move to the PASS HOLD setting.</li> <li>3. Use the scroll wheel to set PASS HOLD.</li> <li>4. Press the EDIT/SAVE key to save and exit the MANU Utility menu.</li> </ol>	    
 Note	<p>The ESC key can be pressed at any time in the MANU Utility menu to cancel and exit.</p>	

### 2.3.13 Setting FAIL MODE

Background	<p>The FAIL MODE settings only apply to the selected test in AUTO tests. FAIL MODE has three options, CONTINUE, HOLD and STOP.</p> <p>When FAIL MODE is set to CONTINUE the tester will continue testing after a FAIL judgment.</p> <p>When set to HOLD, the tester will hold the test on a FAIL judgment, and then continue testing after the START key is pressed.</p> <p>The STOP mode will completely stop the test after a FAIL judgment.</p>	
 Note	<p>The FAIL MODE setting only applies to AUTO tests. This setting is ignored when running MANU tests.</p>	

Steps

1. Press the UTILITY key on the front panel when the tester is in MANU/EDIT status. The display will go from the normal EDIT status to the MANU Utility menu for the current test.



```
MANU=***-002  MANU UTILITY
ARC  MODE:OFF
PASS HOLD:OFF
FAIL MODE:STOP
MAX  HOLD:OFF
GROUND MODE:ON
```

2. Use the UP/DOWN arrow keys to move to the FAIL MODE setting.



3. Use the scroll wheel to set FAIL MODE.

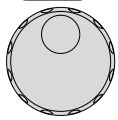

FAIL MODE CONTINUE, HOLD, STOP

4. Press the EDIT/SAVE key to save and exit the MANU Utility menu.



Note

The ESC key can be pressed at any time in the MANU Utility menu to cancel and exit.

### 2.3.14 Setting MAX HOLD

Background

The MAX HOLD setting will hold the maximum current measured in the ACW and DCW tests or the maximum resistance measured in IR and GB tests.

Steps

1. Press the UTILITY key on the front panel when the tester is in EDIT status. The display will go from the normal EDIT status to the MANU Utility menu for *the current test*.



```
MANU=***-002  MANU UTILITY
ARC  MODE:OFF
PASS HOLD:OFF
FAIL MODE:STOP
MAX  HOLD:OFF
GROUND MODE:ON
```



Note

The MANU UTILITY settings only apply to the selected MANU test.

2. Use the UP/DOWN arrow keys to move to the MAX HOLD setting.



3. Use the scroll wheel to set MAX HOLD.

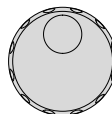

MAX HOLD OFF, ON

4. Press the EDIT/SAVE key to save and exit the MANU Utility menu.

EDIT/SAVE



Note

The ESC key can be pressed at any time in the MANU Utility menu to cancel and exit.

### 2.3.15 Setting the Grounding Mode

#### Background

When GROUND MODE is set to ON, the STW-9000 grounds the return terminal to the ground. This mode is best for DUTs that are grounded to an earth ground by their chassis, fixtures or operation environment. This mode measures the potential of the HIGH VOLTAGE terminal with respect to earth ground. This means that any stray capacitance/resistance that leaks to earth ground will also be measured. This is the safest testing mode, though potentially not as accurate.

When GROUND MODE is set to OFF, the return terminal is floating with respect to the earth ground. This mode is for DUT that are floating and not directly connected to an earth ground. This is more accurate than when GROUND MODE is set to ON as any stray capacitance/resistance that leaks to the earth ground from the DUT side of the testing circuit will not be measured. For this reason, this testing mode is able to measure to a higher resolution. The GROUND MODE is always set to OFF for IR and GB tests.

GROUND MODE = ON, DUT grounded

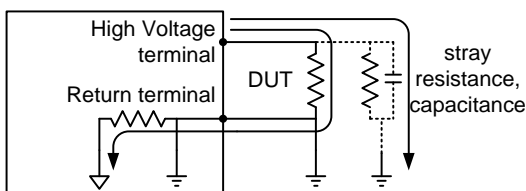

GROUND MODE = ON, DUT floating

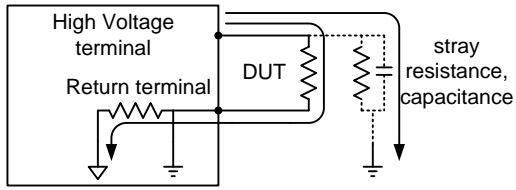

GROUND MODE = OFF, DUT floating

STW-9901/9902/9903

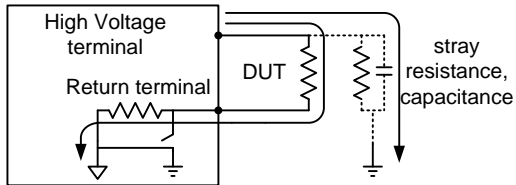

STW-9904 (GB testing)

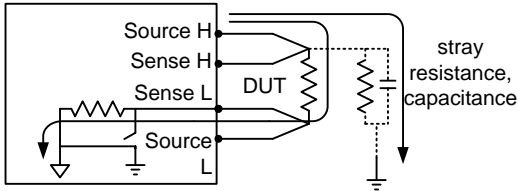

GROUND MODE = OFF, DUT grounded

STW-9901/9902/9903

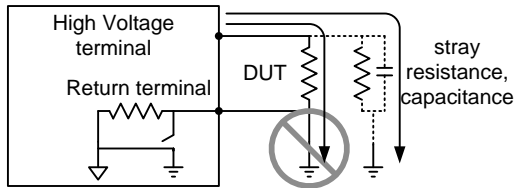

STW-9904 (GB testing)

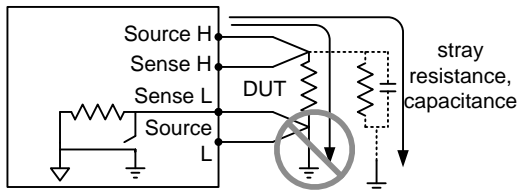





**Warning**

When GROUND MODE is set to OFF, the DUT, fixtures or connected instrumentation cannot be grounded. This will short circuit the internal circuitry during a test. For ACW and DCW tests, if it is not known whether the DUT test setup is grounded or not, always set GROUND MODE to ON. Only set GROUND MODE to OFF when the DUT is floating electrically.

**Steps**

1. Press the UTILITY key on the front panel when the tester is in EDIT status. The display will go from the normal EDIT status to the MANU Utility menu for *the current test*.

UTILITY



```

MANU=***-002  MANU UTILITY
ARC  MODE:OFF
PASS HOLD:OFF
FAIL  MODE:STOP
MAX  HOLD:OFF
GROUND MODE: ON

```



**Note**

The MANU UTILITY settings only apply to the selected MANU test.

2. Use the UP/DOWN arrow keys to move the cursor to the GROUND MODE setting.
3. Use the scroll wheel to set the GROUND MODE.

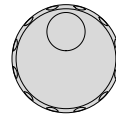

GROUND MODE OFF, ON

4. Press the EDIT/SAVE key to save and exit the MANU Utility menu.
5. The GROUND MODE icon on the display changes accordingly.

EDIT/SAVE



```

_NAME      REF#=
= 01 . 00mA

mA
/ = 000 . 1S  TIMER
GB  [ ]  [HI / L]

```



GROUND  
MODE = OFF

```

_NAME      REF#=
= 01 . 00mA

mA
/ = 000 . 1S  TIMER
GB  [ / ]  [HI / L]

```



GROUND  
MODE = ON



**Note**

The ESC key can be pressed at any time in the MANU Utility menu to cancel and exit. IR and GB tests can only have GROUND MODE set to OFF.

### 2.3.16 Saving and Exiting EDIT Status

**Background** After all test parameters have been set, the test can be saved. After a test is saved it can be used when creating an AUTO test.



**Warning**

The special MANU number, 000, can be saved, however it cannot be used for AUTO tests. See page 39 for details.

**Steps**

1. When in EDIT status, press the EDIT/SAVE key to save the current test. This will enter the VIEW status for the chosen test number.

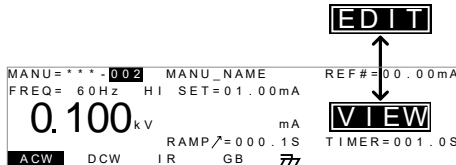

2. The Status changes from EDIT to VIEW.



**Note**

Pressing the EDIT/SAVE key again will return the tester back to EDIT status for the current test.

### 2.3.17 Running a MANU Test

**Background** A test can be run when the tester is in READY status.



**Note**

The tester cannot start to run a test under the following conditions:

- A protection setting has been tripped; when a protection setting has been tripped the corresponding error message is displayed on the screen. See page 94 for a comprehensive list of the all the setting errors.
- The INTERLOCK function is ON and the Interlock key is not inserted in the signal I/O port (page 58).
- The STOP signal has been received remotely.

If Double Action is ON, ensure the START button is pressed immediately after the STOP button (<0.5s).



**Note**

When a test is running the voltage output cannot be changed, unless the test is under the special manual mode. See page 39 for details.

**Steps**

1. Ensure the tester is in VIEW status for the current test. Save the current test if necessary. Page 32

### VIEW status

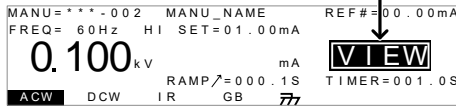

2. Press the STOP button to put the tester into the READY status.

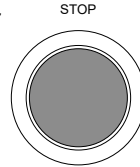

### READY status

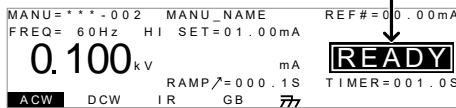

3. The READY indicator will be lit blue when in the READY status.
4. Press the START button when the tester is in the READY status. The manual test starts automatically and the tester goes into the TEST status.

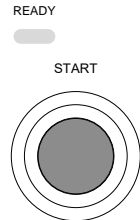

5. The TEST indicator will be lit orange when in the TEST status.

### TEST status

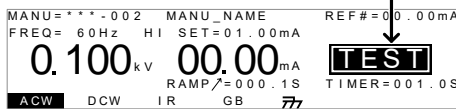

6. The test will start by showing the remaining ramp up time, followed by the remaining test time. The test will continue until the test is finished or the test is stopped.



remaining RAMP<sup>^</sup> time

remaining TIMER time

## ACW Example

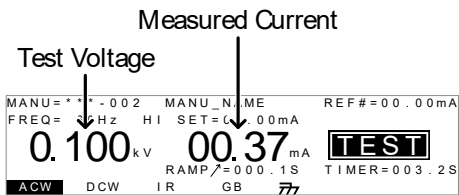

## DCW Example

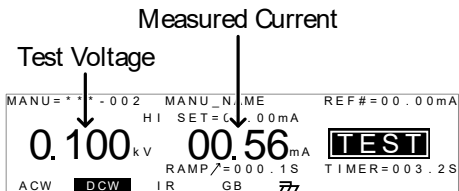

## IR Example

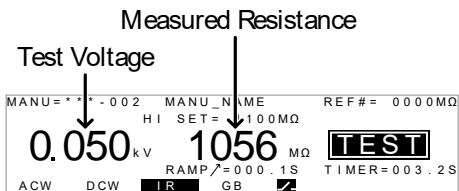

## GB Example

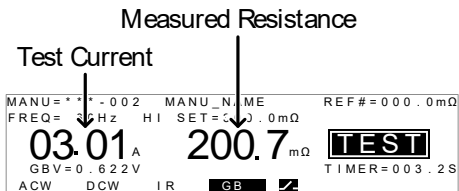

## Stop the Test

- To stop the test at any time when it is running, press the STOP button. The test will stop immediately. When the STOP button is pressed, a judgment is not made on the test. All panel keys except the STOP button are locked when the tester is in STOP status.

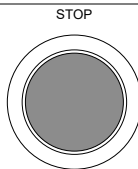

## STOP status



- To put the tester back into READY status, press the STOP button again.

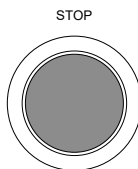

## Exit TEST Status

To exit testing, press the MANU/AUTO key when the tester is in the READY status. The tester will revert to the VIEW status for the current test.

MANU/AUTO

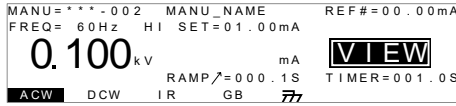

Note

Do not touch any terminals, test leads or any other connections when the test is on.

## 2.3.18 PASS / FAIL MANU Test

### Background

If the test is allowed to run to completion (the test is not stopped or a protection setting is not tripped) then the tester will judge the test as either PASS or FAIL.



Note

The test will be judged PASS when:

- The HI SET and LO SET limits have not been tripped during the test time.

The test will be judged FAIL when:

- Either the HI SET or LO SET limit has been tripped during the test time.
- A protection setting has been tripped during the test time. See page 94 for a list of error messages.

### PASS Judgment

1. When the test is judged as PASS, PASS will be displayed, the buzzer will sound and the PASS indicator will be lit green.

PASS

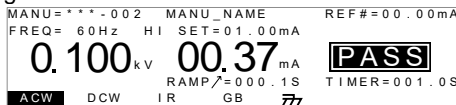

2. The PASS judgment will be held on the display until the STOP or START button is pressed.

Pressing the STOP button will return the tester to the READY status.

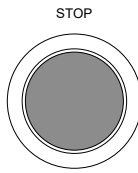

Pressing the START button will restart the test.

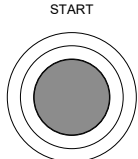



Note

The buzzer will only sound if the Pass Sound is set to ON. See page 55 for details.

The START button is disabled when the buzzer is beeping.

### PASS Timing Diagrams

The timing diagrams below show the ACW, DCW, IR and GB timing for the START status, TEST status and PASS judgment.

#### ACW PASS Timing

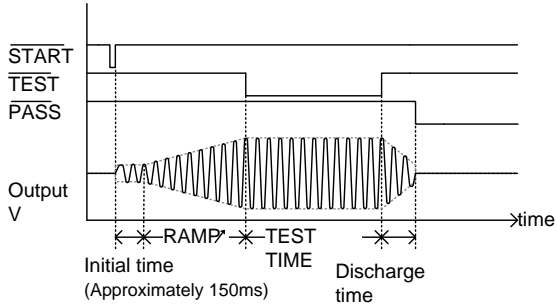

#### DCW PASS Timing

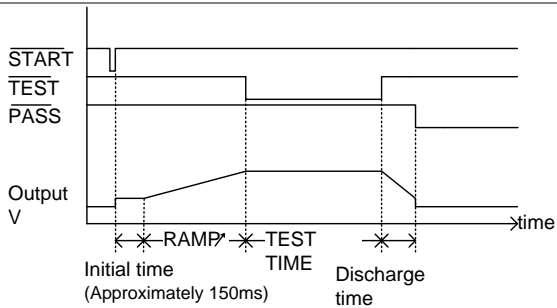

#### IR PASS Timing

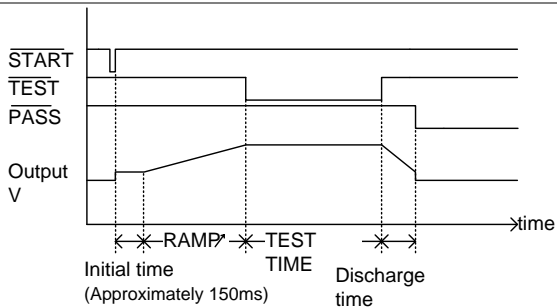

## GB PASS Timing

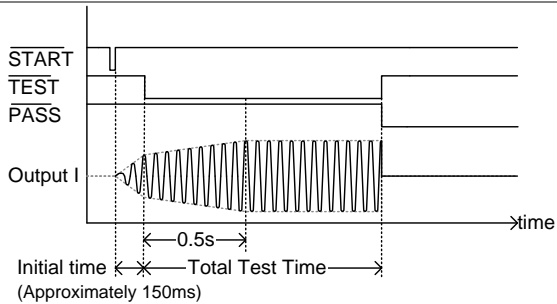

## FAIL Judgment

1. When the test is judged as FAIL, FAIL will be displayed, the buzzer will sound and the FAIL indicator will be lit red. As soon as a test is judged FAIL, power is cut from the terminals.

FAIL

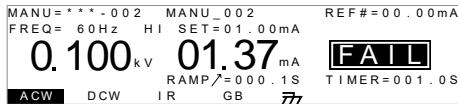

2. The FAIL judgment will be held on the display until the STOP button is pressed. Pressing the STOP button twice will return the tester to the READY status.

STOP

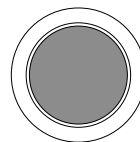

3. The READY indicator will be lit blue in the READY status.

READY



READY status

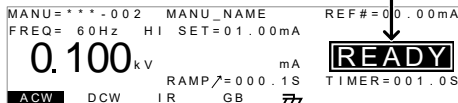

Note

The buzzer will only sound if Fail Sound is set to ON. See page 55 for details.

## FAIL Timing Diagrams

The timing diagrams below show the ACW, DCW, IR and GB timing for the START status, TEST status and FAIL judgment.

### ACW FAIL Timing

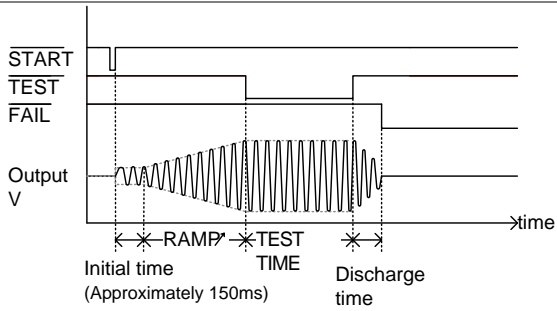

### DCW FAIL Timing

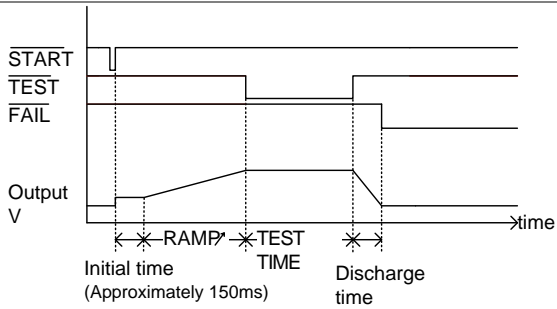

### IR FAIL Timing

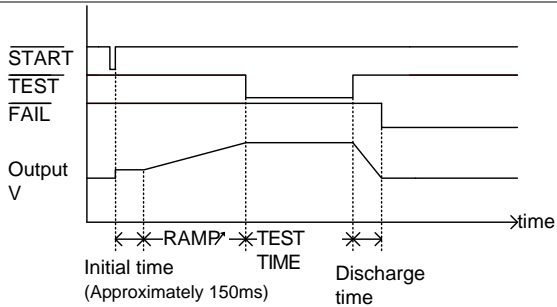

### GB FAIL Timing

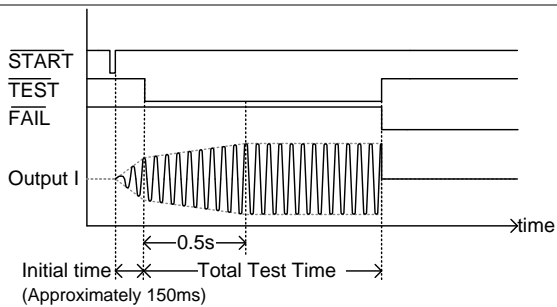



### 2.3.19 Zeroing of the Test Leads (GB only)

#### Background

The Zeroing function is used to determine the resistance of the test leads for GB tests. When a zero check is performed, the reference is automatically set to the measured resistance of the test leads. This function is only available for GB testing.

#### Steps

1. Ensure the tester is in VIEW status for Page 32 the current GB test. Save the current test if necessary.



2. Short the positive and negative alligator clips as shown below.

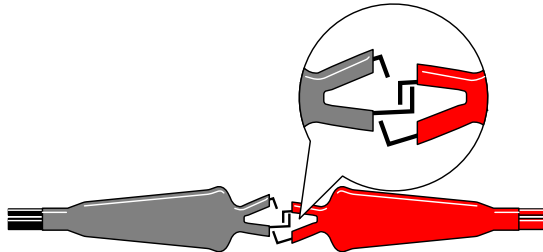

3. Press the STOP button to put the tester into the READY status.

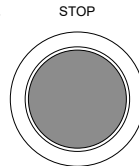

4. The ZERO function can be activated by pressing the corresponding soft-key in the READY status. The ZERO soft-key will be highlighted.



5. Press the START button to perform the zero check. The tester will go into the ZERO status.

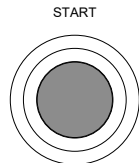

Measured Resistance

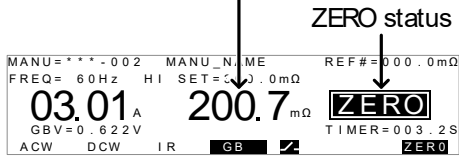

- When the zero check has finished, the tester will return back to the VIEW status. The resistance of the test leads will be automatically set as the Reference value.

Reference value

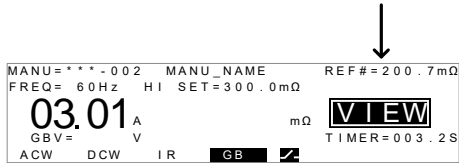

Note

Remember to replace the test leads to the proper position on the DUT before testing.

I<SET

If SOURCE H/L terminals are open or poorly connected, then an I<SET error will appear on the screen. Stop the test and re-check the connection again and try again.

I<SET error message



R = 0

Stop the test and perform the zero check again.

R = 0 error message

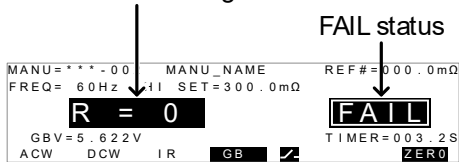

### 2.3.20 Special MANU Test Mode (000)

**Special Test Mode Overview** When MANU number 000 is selected, the special test mode is activated. Under the special test mode, the voltage can be changed during a test, in real time (ACW, DCW only). The test function can also be changed when in READY or VIEW status, unlike under normal operation. Separate settings can be saved under the special test mode for each of the testing functions: ACW, DCW, IR and GB. This means a different ACW, DCW, IR and GB test setup can be saved for MANU number 000.

**Sweep Function Overview** The STW-9900 has access to the sweep mode function. The sweep function creates a graph of one of the ACW, DCW, IR or GB tests in the special manual mode. The graph will plot the output voltage, current or resistance versus time. After the test has been completed, the test current, voltage or resistance at any point in time can be viewed in the graph. Below is an example of the resultant sweep plot of a DCW test where a DC voltage is ramped up to a user-defined level until the HI SET current level has been tripped or the test time runs out.

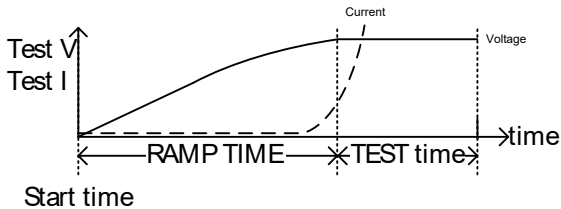

Start time

Legend: Voltage: ——— Current - - -

The test items that are plotted on the sweep graph depend on the type of test that is performed.

TEST	Graph Test Items
ACW	Test voltage, test current (V, I)
DCW	Test voltage, test current (V, I)
IR	Test voltage, test resistance (V, R)
GB	Test current, test resistance (I, R)

Steps

1. Choose MANU number 000 to enter the special test mode. Page 18
2. The settings of a previous test can be loaded by pressing the corresponding soft-key in the VIEW or READY status.  Example: ACW  
For example, if you are currently in DCW mode, pressing the ACW key will load the ACW settings that were previously used in the special manual mode.
3. Set all the necessary parameters for a test and save. Pages 18~32  
Note: A different test setup can be saved for each test function (ACW, DCW, IR and GB).

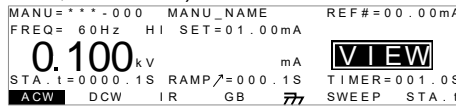

STW-9000 shown.



Note

The TIMER settings can be set OFF when in the special test mode for ACW and DCW tests. If the TIMER settings are set to OFF, the sweep function will not produce a graph.

Setting the Sweep Start Time

1. When in the VIEW status, press the STA.t key and set the starting time for the sweep graph. Make sure that the sweep start time is significantly less than the test time.   
This setting is only applicable for the STW-9900 series.

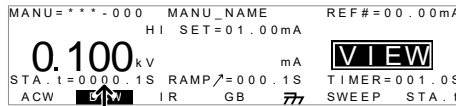

Start time

2. Press the EDIT/SAVE key to save the Start time. 

Running the Test

1. In special test mode (000), tests are started and stopped in the same way as for the normal manual test mode. Page 32  
See page 32 for details.

- If required, the scroll wheel can be used to set the voltage level in real-time as the test is running (this does not apply to IR or GB tests).

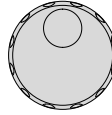

ACW 0.100kV ~ 5kV

DCW 0.100kV ~ 6kV

**Results** Test judgments are the same as those for the normal manual tests. Please see the PASS/FAIL MANU Test section for details. Page 35

**View Sweep Graph** Unlike normal manual tests, the special test mode also has an option to view the resultant test as a sweep graph. This option is only applicable for the STW-9900 series.

- When the test has finished, press the SWEEP key to view the results of the sweep in a graph. 

Graph Test Items:		
TEST	Primary	Secondary
ACW	Test voltage	test current
DCW	Test voltage	test current
IR	Test voltage	test resistance
GB	Test current	test resistance

**DCW Example**

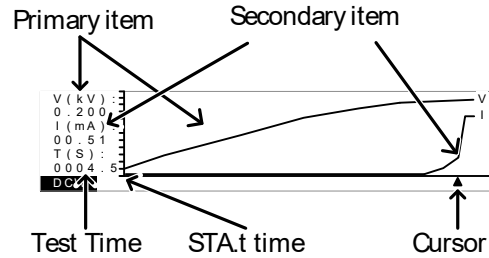

- Use the scroll wheel to move the cursor on the time axis (x-axis). The measured values for the primary and secondary items at that particular point in time are shown on the left-hand side.

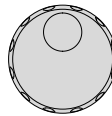

**Remove Lines from the Graph** 1. Pressing the F5 key will toggle the primary test item on/off.

- Pressing the F6 key will toggle the secondary test item on/off.

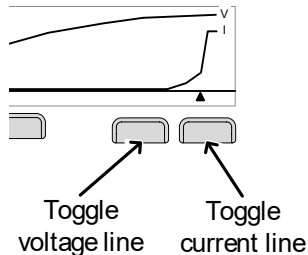

Example: DCW test

Exit the Results Graph

To exit the graph, press the ESC key. You will be returned back to MANU mode/VIEW status.



## 2.4 Automatic Tests

This section describes how to create, edit and run automatic tests. Automatic tests allow you to link together up to 16 different MANU tests and run them sequentially. Each stored MANU test is used as a test step when creating an AUTO test.

Before operating the STW-9000 please read the safety precautions as outlined in the Set Up chapter on page 8.

### 2.4.1 Choose/Recall an Automatic Test

Background

The tester must first be put into AUTO mode to create or run automatic tests. Up to 100 automatic tests can saved/recalled.

Steps

1. If the tester is in MANU mode, press and hold the MANU/AUTO key for three seconds. This will put the tester into Auto mode. The tester can only switch between AUTO and MANU mode when in the VIEW status.

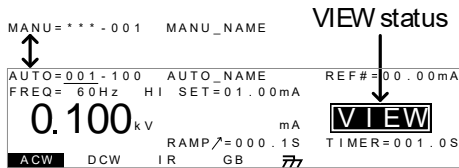

Note

If the chosen automatic test has not yet been setup, then the screen will be blank except for the status and mode.



2. Use the scroll wheel to choose the AUTO number.

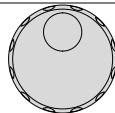

AUTO # 001~100  
AUTO number

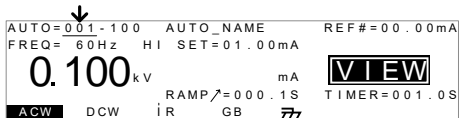



Note

The AUTO number can only be chosen in VIEW status. If in the EDIT status, switch to the VIEW status by pressing the EDIT/SAVE or ESC key.

### 2.4.2 Edit Automatic Test Settings

**Background** To edit an automatic test, the tester must be in EDIT status.  
Any settings or parameters that are edited only apply to the currently selected AUTO number.

- Steps**
1. Press the EDIT/SAVE key when in VIEW status to enter the EDIT status. This will enter the EDIT status for the chosen AUTO number.

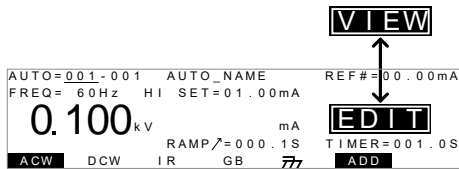

2. The Status changes from VIEW to EDIT. The tester is now ready to edit the current AUTO test.



Note

Pressing the EDIT/SAVE key again will save the settings or pressing the ESC will cancel the settings for the current AUTO test and return back to VIEW status.

### 2.4.3 Adding a Step to the Automatic Test

**Background** Up to 16 MANU tests (steps) can be added to an automatic (AUTO) test. Each step is added in a sequential order.

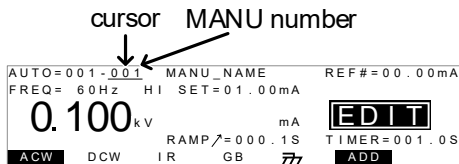

- Steps**
1. Press the DOWN arrow keys to bring the cursor to the MANU number.

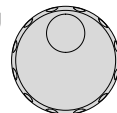

2. Use the scroll wheel to choose a MANU number to add to the automatic test.



MANU number 001~100

- Press the ADD soft-key to add the selected manual test to the automatic test as another step.  
- Repeat steps 2 and 3 for any other tests that you wish to add to the automatic test.



Note

After 16 steps have been added to an AUTO test, FULL will be shown on the display when you attempt to add another step to the AUTO test.

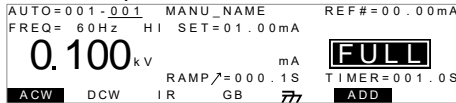

Note

The test order can be edited in the Page View menu after the AUTO test is saved. See page 47 for details.

## 2.4.4 Creating an AUTO Test File Name

### Background

Each automatic test can have a user-defined test file name (Default: AUTO\_NAME) up to 10 characters long. See the character list below for the allowed characters.

Character List

0	1	2	3	4	5	6	7	8	9																
A	B	C	D	E	F	G	H	I	J	K	L	M	N	O	P	Q	R	S	T	U	V	W	X	Y	Z
a	b	c	d	e	f	g	h	i	j	k	l	m	n	o	p	q	r	s	t	u	v	w	x	y	z
+	-	*	/	_	=	:	Ω	?	(	)	<	>	[	]											

### Steps

- Use the UP/DOWN arrow keys to bring the cursor to the AUTO number. A small cursor will also appear under the first character of the AUTO test file name. This is initially set as AAUTO\_NAME



cursor    AUTO test file name

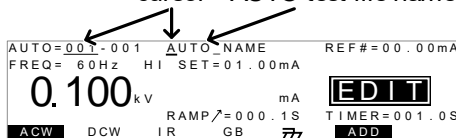

- Use the scroll wheel to scroll through the available characters.

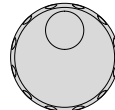

- Press the LEFT/RIGHT arrow keys to go to the next character.
- The AUTO test file name is set when the current AUTO test is saved or when the cursor is moved to another setting.







Note

To cancel the name changes, press the ESC key before the cursor is moved to another setting or the name is saved.

## 2.4.5 Saving and Exiting EDIT Status

Background

After all test steps have been added to an automatic test, the automatic test can be saved.

Steps

1. When in EDIT status, press the EDIT/SAVE key to save the automatic test. After the test is saved the tester will revert back to VIEW status.

EDIT/SAVE

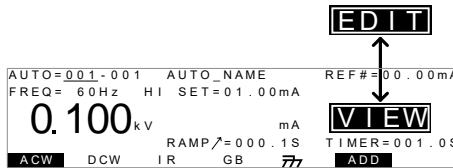

2. The status changes from EDIT to VIEW.



Note

Pressing the EDIT/SAVE key again will return the tester back to EDIT status for the selected AUTO test.

## 2.4.6 Automatic Test Page View

Background

Pressing the PAGE key will show an overview of the tests for the currently selected automatic test when in the VIEW status. The Page View will show the order of the AUTO test steps as well as the manual file name, function, test voltage/current and HI/LO SET limits.

Steps

1. Ensure the tester has had an automatic Page 44 test saved and the tester is in AUTO mode/VIEW status.

AUTO mode

VIEW status

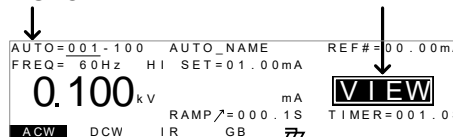

2. Press the PAGE key to bring up the Page view of the AUTO test.

PAGE



All the test steps are shown on the bottom of the screen along with the corresponding MANU numbers. The top of the screen shows the selected MANU test file name and the settings (test function, test voltage, HI/LO SET).

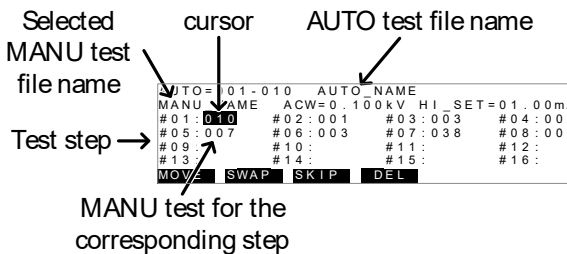

**Editing** When in the Page View, the automatic test steps can be edited. Steps can be deleted, skipped, moved or swapped.

**Moving a Step**

1. Use the UP/DOWN and LEFT/RIGHT arrow keys to move the cursor to the test step you wish to move.
2. Press the MOVE soft-key.
3. Use the UP/DOWN and LEFT/RIGHT arrow keys to move the cursor to the destination step.
4. Press the MOVE soft-key again. The manual test will be moved to the destination step. The remaining steps will move up/down to fill the empty step.

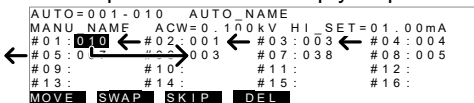
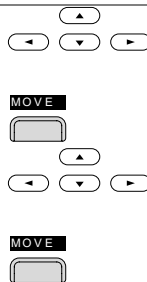

**Swapping Two Steps**

1. Use the UP/DOWN and LEFT/RIGHT arrow keys to move the cursor to the test step you wish to swap.
2. Press the SWAP soft-key.
3. Use the UP/DOWN and LEFT/RIGHT arrow keys to move the cursor to the second step.
4. Press the SWAP soft-key again. The tests will be swapped with each other.

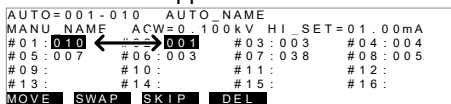
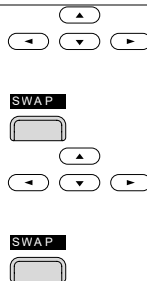

**Skip a Test Step**

1. Use the UP/DOWN and LEFT/RIGHT arrow keys to move the cursor to the test step you wish to skip.
2. Press the SKIP soft-key.

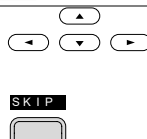

- The step will have an asterisk beside the MANU number.



```
AUTO=001-010 AUTO_NAME
MANU_NAME ACW=0.100kV HI SET=01.00mA
# 01: 010* # 02: 001 # 03: 003 # 04: 004
# 05: 007 # 06: 003 # 07: 038 # 08: 005
# 09:      # 10:      # 11:      # 12:
# 13:      # 14:      # 15:      # 16:
MOVE SWAP SKIP DEL
```



#### Note

The next time the automatic test is run, the steps with asterisks will be skipped.

#### Delete a Test Step

- Use the UP/DOWN and LEFT/RIGHT arrow keys to move the cursor to the test step you wish to delete.
- Press the DEL soft-key.
- The step will be deleted.



#### Save Changes and Exit

To save the changes made in Page View, press the EDIT/SAVE key. You will be returned back to AUTO mode/VIEW status.



#### Cancel and Exit Page View

To cancel any changes and to exit the Page View, press the ESC key. You will be returned back to AUTO mode/VIEW status.



## 2.4.7 Running an Automatic Test

#### Background

An automatic test can be run when the tester is in READY status.



#### Note

The tester cannot start to run an AUTO test under the following conditions:

- Any protection modes have been tripped.
- The INTERLOCK function is ON and the Interlock key is not inserted in the signal I/O port (page 62).
- The STOP signal has been received remotely. If Double Action is ON, ensure the START button is pressed immediately after the STOP button (<0.5s).



#### Warning

Do not touch any terminals, test leads or the DUT when a test is running.

#### Steps

- Ensure the tester is in VIEW status. Page 44  
Save the automatic test if necessary.

VIEW status

```
AUTO=001-100 AUTO_NAME REF#=00.00mA
FREQ=60Hz HI SET=01.00mA
0.100kV mA
RAMP=000.1S TIMER=001.0S
ACW DCW IR GB 77
```

2. Press the STOP button to put the tester into the READY status.

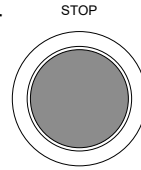

READY status

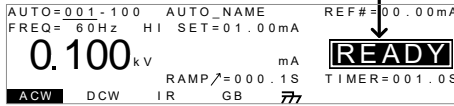

3. The READY indicator will be lit blue when in the READY status.
4. Press the START button when the tester is in the READY status. The AUTO test starts automatically and the display changes to TEST status.

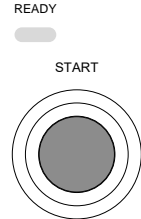

5. The TEST indicator will be lit orange when in the TEST status.
6. Each test will start by showing the remaining ramp up time, followed by the remaining test time. Each test will be tested in sequence until the last test has finished or the test is stopped.



remaining RAMP time  
remaining TIMER time

- 
- PASS/FAIL HOLD
1. If Pass Hold is set to ON or Fail Mode is set to HOLD for a manual test, then the tester will "hold" the testing after a Pass/Fail result for that particular test. See page 26, 27 for details.

HOLD status

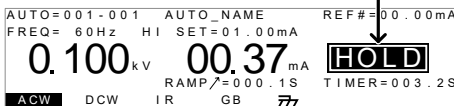

2. The PASS or FAIL indicator will also be lit. The buzzer will NOT sound.



- To continue to the next test after HOLD is displayed on-screen, press the START button.

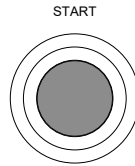

- To stop the test when HOLD is displayed on-screen, press the STOP button.

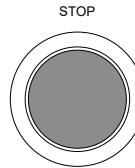

**Note**

When in HOLD status, only the START and STOP buttons can be pressed, all other keys are disabled.

**Stop a Running Test**

- To stop the AUTO test at any time when it is running, press the STOP button. The AUTO test will stop immediately. When the STOP button is pressed, a judgment is not made on the current test and any remaining tests are aborted.

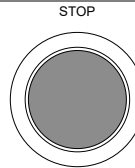

All panel keys except the STOP and START buttons are locked when the tester has been stopped. All the results up until when the AUTO test was stopped are shown on-screen. See page 52 for more details on automatic test results.

AUTO=001-***		AUTO_NAME	
# 01 : FAIL	# 02 : PASS	# 03 : STOP	# 04 : ---
# 05 : ---	# 06 : ---	# 07 : ---	# 08 : ---
# 09 :	# 10 :	# 11 :	# 12 :
# 13 :	# 14 :	# 15 :	# 16 :

Example of an automatic test that has been stopped. Dashes (-) indicate aborted test steps.

- To put the tester back into READY status, press the STOP button again.

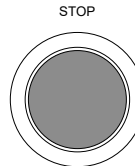

**Exit Testing**

To exit testing, press the MANU/AUTO key when the tester is in the READY status. The tester will revert to the VIEW status for the current automatic test.



AUTO=001-100		AUTO_NAME		REF#=00.00mA	
FREQ= 60Hz		HI SET=01.00mA			
<b>0.100</b> kV		mA		<b>VIEW</b>	
RAMP/ = 000.1S		TIMER=001.0S			
ACW	DCW	IR	GB	77	

## 2.4.8 Automatic Test Results

### Background

If all the test steps are allowed to run to completion (the AUTO test is not stopped or a protection setting is not tripped) then the tester will judge each step as either PASS or FAIL. This is shown as a table after the automatic test has finished running. If the test has been stopped, then any remaining tests will not be run and thus the AUTO test will not finish running.

### Overview

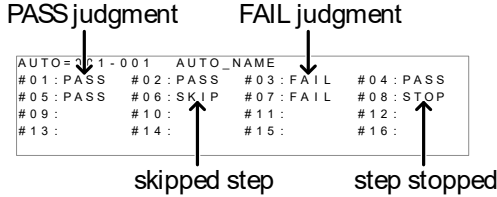

### Note

The PASS/FAIL judgment for an automatic test as a whole depends on the results of all the steps (manual tests) that compose the automatic test:

- Each step must be passed for a PASS judgment (excluding skipped tests).
- A FAIL result for a single step will result in FAIL for the whole automatic test.
- A STOP. No step can be stopped for a PASS/FAIL judgment to be made. In other words, if a test is stopped, it is judged as neither PASS nor FAIL.
- No step can contain an ERROR or ILOCK message.

ERROR message
ILOCK message

AUTO=001-001		AUTO_NAME			
# 01: ERROR	# 02: PASS	# 03: ILOCK	# 04: PASS		

**ERROR:** Indicates that V, I or R is not correct. This usually occurs if the testing leads are not properly connected.

**ILOCK:** Indicates that the interlock key is disconnected (if configured to be used).

### PASS Judgment

When all the tests have been judged as PASS, the PASS indicator will be lit green and the buzzer will sound.

PASS



AUTO=001-***		AUTO_NAME			
# 01: PASS	# 02: PASS	# 03: PASS	# 04: PASS		
# 05: PASS	# 06: PASS	# 07: PASS	# 08: PASS		
# 09:	# 10:	# 11:	# 12:		
# 13:	# 14:	# 15:	# 16:		



### Note

The Pass Sound setting must be set to ON for the buzzer to sound (page 56).

FAIL Judgment

When any of the tests have been judged as FAIL, the FAIL indicator will be lit red and the buzzer will sound.

FAIL



AUTO=001-*** AUTO_NAME			
# 01 : PASS	# 02 : PASS	# 03 : PASS	# 04 : PASS
# 05 : PASS	# 06 : FAIL	# 07 : FAIL	# 08 : PASS
# 09 :	# 10 :	# 11 :	# 12 :
# 13 :	# 14 :	# 15 :	# 16 :

Note

The Fail Sound setting must to set to ON for the buzzer to sound (page 56).

View Results

1. When the PASS or FAIL overview table is shown on the screen, turn the scroll wheel right to scroll through each test step.

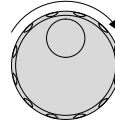

step number →

MANU number for current step →

PASS/FAIL result ↑

STEP: 02-003 MANU\_NAME REF#=00.00mA  
 FREQ= 60Hz HI SET=01.00mA  
 0.100 kV 00.37 mA PASS  
 RAMP/=000.0S TIME=003.2S  
 ACW DCW IR GB 77

2. Turn the scroll wheel left to return back to the overview table.

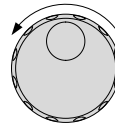

Return to Ready Status

1. The PASS/FAIL results will be held on the screen until the STOP button is pressed.
2. To put the tester back into READY status, press the STOP button (twice for a fail result).

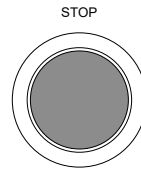

3. The READY indicator will be lit blue in the READY status.

READY

READY status

READY status ↓

AUTO=001-100 AUTO\_NAME REF#=00.00mA  
 FREQ= 60Hz HI SET=01.00mA  
 0.100 kV 00.37 mA READY  
 RAMP/=000.1S TIMER=001.0S  
 ACW DCW IR GB 77

### Exit Testing

To exit testing, press the MANU/AUTO key when the tester is in the READY status. The tester will revert to The VIEW status.

MANU/AUTO



AUTO=001-100	AUTO_NAME	REF#=00.00mA
FREQ=60Hz	HI SET=01.00mA	
<b>0.100</b> kV	mA	<b>VIEW</b>
ACW	DCW	RAMP/=000.1S
IR	GB	TIMER=001.0S
		77

### PASS Timing Diagram

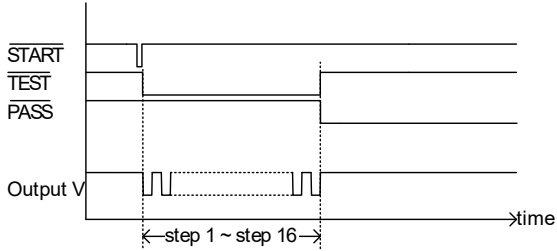

### FAIL Timing Diagram

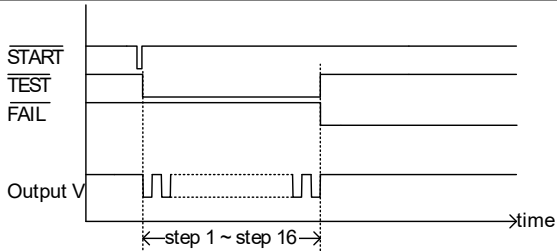



## 2.5 Common Utility Settings

The Common Utility settings are system-wide settings that apply to both MANU tests and AUTO tests.

The Common Utility menu includes the following settings:

### 2.5.1 LCD Settings

**Description** The LCD settings include contrast and brightness controls.

**Steps** 1. Ensure the tester is in VIEW status. Page 32  
Save the current test if necessary.

VIEW status

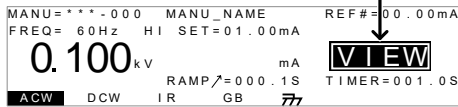

2. Press the UTILITY key.



3. Press the LCD soft-key to bring up the LCD Common Utility menu.



4. Use the UP/DOWN arrow keys to choose a menu item: LCD Contrast, LCD Brightness.



5. Use the scroll wheel to select a parameter for the chosen menu item.

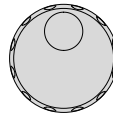

LCD Contrast      1(low) ~ 8(high)  
LCD Brightness    BRIGHT, DARK

6. Press EDIT/SAVE to save the settings and exit to VIEW status.



Note

The ESC key can be pressed at any time to cancel and exit back to VIEW status.

## 2.5.2 Buzzer Settings

**Description** The Buzzer settings allow you to set whether the buzzer will sound for PASS/FAIL judgments. The buzzer time can also be set for the PASS/FAIL judgments. The buzzer settings are system-wide.

**Steps** 1. Ensure the tester is in VIEW status. Page 32  
Save the current test if necessary.

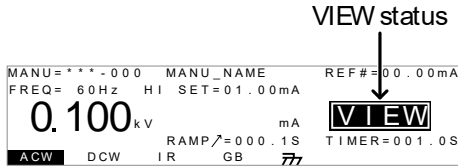

2. Press the UTILITY key.
3. Press the BUZZ soft-key to bring up the Buzzer Common Utility menu.

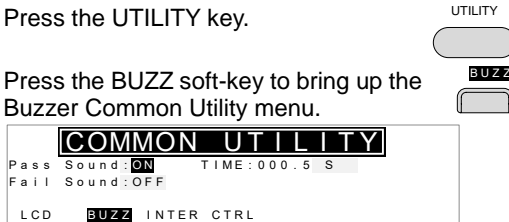

4. Use the UP/DOWN arrow keys to choose a menu item: Pass Sound or Fail Sound.
5. Use the scroll wheel to select a parameter for the chosen menu item.

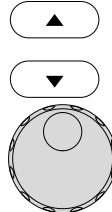

Pass Sound            ON (000.2s~999.9s), OFF  
Fail Sound            ON (000.2s~999.9s), OFF

6. Press EDIT/SAVE to save the settings and exit to the VIEW status.



Note

When in automatic tests, the Pass Sound and Fail Sound settings only apply to the overall PASS/FAIL of the *overall automatic test*, not each test step that make up the automatic tests.

Note

The ESC key can be pressed at any time to cancel and exit back to VIEW status.



## 2.5.3 Interface Settings

**Description** The interface settings choose the remote interface configuration. USB, RS-232C and GP-IB (optional) can be selected.

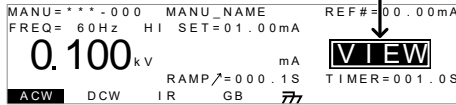

- Steps**
1. Ensure the tester is in VIEW status. Page 32  
Save the current test if necessary.

VIEW status



2. Press the UTILITY key. 
3. Press the INTER soft-key to bring up the Interface Common Utility menu. 

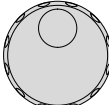

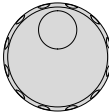
4. Use the scroll wheel to select USB, RS232 or GPIB. 
5. For RS232 or GPIB, use the UP/DOWN arrow keys to choose Baud or Address.   

6. Use the scroll wheel to select the baud rate or GP-IB address. 

Baud 9600, 19200, 38400, 57600, 115200  
GP-IB address 0~30

7. Press EDIT/SAVE to save the settings and exit to VIEW status. 



Note

Ensure the baud rate settings or GP-IB address matches the host machine.



Note

The ESC key can be pressed at any time to cancel and exit back to VIEW status.

## 2.5.4 Control Settings

### Description

The Control settings are accessed in the COMMON UTILITY menu. The Control settings include: Start Control, Double Action, Key Lock and Interlock. Start Control is used to determine how a test is started. Tests can be started via the front panel (START/STOP buttons), from a remote controller or via the SIGNAL I/O port.

The Double Action function is a safety feature used to prevent accidentally starting a test. Normally to start a test, the START button is pressed when the tester is in the READY status. To start a test when Double Action is ON, the STOP button must first be pressed, followed by the START button within 500ms.



Key Lock disables the front panel keys from changing the test number, mode or testing parameters. Only the Utility menu and any keys required for testing are not disabled.

The Interlock function is a safety feature. The interlock function prevents a test from running, unless the interlock pins on the signal I/O port connector are shorted. The included interlock key can be used for this purpose. See page 62 for details.

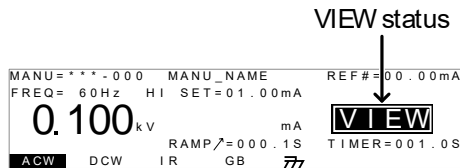

### Steps

1. Ensure the tester is in VIEW status. Page 32  
Save the current test if necessary.

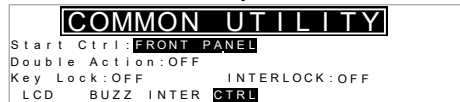

2. Press the UTILITY key. 
3. Press the CTRL soft-key to bring up the Control Common Utility menu. 

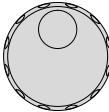

4. Use the UP/DOWN arrow keys to choose a menu item: Start Ctrl, Double Action, Key Lock or INTERLOCK.  
5. Use the scroll wheel to select setting for the chosen menu item. 

Start Ctrl	FRONT PANEL, REMOTE
	CONNECT, SIGNAL IO
Double Action	ON, OFF
Key Lock	ON, OFF
INTERLOCK	ON, OFF

6. Press EDIT/SAVE to save the settings and exit to VIEW status.

EDIT/SAVE



Note

The Double Action setting is ignored when the STW-9000 is being controlled remotely using the USB, RS-232C or GP-IB interfaces.



Note

If a test is started with INTERLOCK ON, but the interlock signal I/O pins are not shorted (either with the included interlock key or manually), the INTERLOCK OPEN message will be displayed, preventing the test from starting.

### Interlock open message

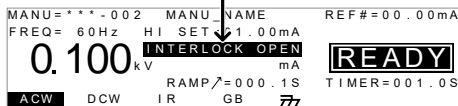

### 3. EXTERNAL CONTROL

The External Control chapter covers the REMOTE terminal and the SIGNAL I/O port.

#### 3.1 External Control Overview

The External Control section describes the front panel REMOTE terminal connection and the rear panel SIGNAL I/O port.

##### 3.1.1 Remote Terminal Overview

**Overview** The REMOTE terminal connector is a standard 5-pin DIN terminal suitable for a remote controller.



**WARNING**

Keep any cables that are connected to the REMOTE terminal away from the HIGH VOLTAGE and RETURN terminals.

**Pin Assignment and Connection**

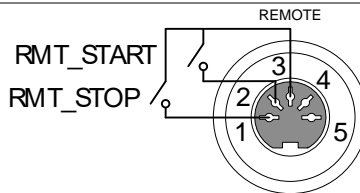

Pin	Pin name	Description
1	RMT_STOP	Remote Stop signal
2	RMT_START	Remote Start signal
3	COM	Common line
4	Not used	
5	Not used	

##### Signal Properties

High level input voltage	2.4V~3.3V
Low level input voltage	0~0.8V
Input period	minimum of 1ms

##### 3.1.2 Remote Controller Operation

**Description** The STW-9000 accepts external remote controllers with a START and STOP button. To use the REMOTE terminal, the STW-9000 must first be configured to accept a remote controller. Operating a remote controller is the same as operating the START and STOP buttons on the front panel.

**Steps**

1. Insert the lead of remote controller into the REMOTE terminal.

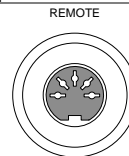

2. Configure the Start Ctrl option to REMOTE CONNECT in the Common Utility menu. Page 57
3. The tester will now only be able to start a test using a remote controller.



**NOTE**

Even if the STW-9000 is configured to use the REMOTE CONNECT option, the STOP button on the front panel can still be used to stop a test.

4. To return the operation control to the front panel, configure the Start Ctrl option to FRONT PANEL. Page 57

### 3.2 SIGNAL I/O Overview

**Overview** The SIGNAL I/O port can be used to remotely start/stop tests and monitor the test status of the instrument. The SIGNAL I/O port is also used for the interlock function (page 58). The SIGNAL I/O port uses a DB-9 pin female connector.

**Pin Assignment**

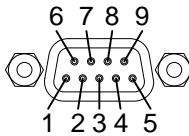

Pin name	Pin	Description
INTERLOCK1	1	When INTERLOCK is ON, a test is only allowed to start
INTERLOCK2	2	when both INTERLOCK pins are shorted.
INPUT_COM	3	Common input line
INPUT_START	4	Start signal input
INPUT_STOP	5	Stop signal input
OUTPUT_TEST	6	Indicates that a test is in progress
OUTPUT_FAIL	7	Indicates that a test has failed
OUTPUT_PASS	8	Indicates that a test has passed
OUTPUT_COM	9	Common output line

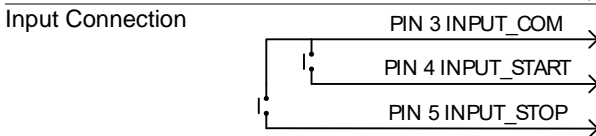
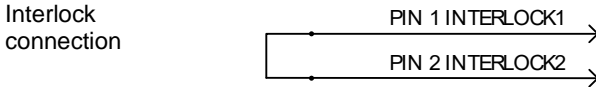

## Output Connection

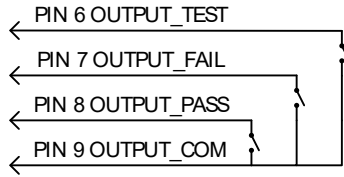

## Signal Properties

### Input Signals

High level input voltage	5V ~ 32V
Low level input voltage	0V ~ 1V
Low level input current	Maximum of -5mA
Input period	Minimum of 1ms

### Output Signals

Output Type	Relay form A
Output Rated Voltage	30VDC
Maximum output current	0.5A

## 3.2.1 Using the SIGNAL I/O to Start/Stop Tests

**Background** To use the SIGNAL I/O port the Start Ctrl settings have to be set to SIGNAL I/O in the Common Utility menu.

- Panel operation**
1. Set the Start Ctrl option to SIGNAL I/O. Page 57
  2. Connect the Input/Output signals to the SIGNAL I/O port.
  3. To start the testing, short the INPUT\_STOP and INPUT\_COM line for a minimum of 1ms to put the tester into READY status.
  4. To start the testing, short the INPUT\_START and INPUT\_COM lines for a minimum of 1ms.
  5. To stop the testing, temporarily short the INPUT\_STOP and INPUT\_COM line again.



### NOTE

Even if the STW-9000 is configured to use the SIGNAL I/O interface, the STOP button on the front panel can still be used to stop a test.

## 3.2.2 Using the Interlock Key

**Background** When the INTERLOCK function is set to ON, tests are only allowed to start when both Interlock pins on the signal I/O port are shorted. Using the Interlock key will short the INTERLOCK1 and INTERLOCK2 pins on the signal I/O port.  
See page 61 for the Signal I/O pin assignment.



Panel operation

1. Insert the Interlock key into the SIGNAL I/O port on the rear panel.

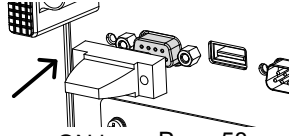

2. Set the INTERLOCK option to ON in Page 58 the Common Utility.



Note

With INTERLOCK set to ON, the tester can now only start a test when the Interlock key is connected. Do not remove the interlock after starting a test. It must be connected after a test has started or is running. Set INTERLOCK to OFF to disable this feature.



---

## 4. REMOTE CONTROL

This chapter describes basic configuration of IEEE488.2 based remote control. The remote interface supports USB, RS-232C and GP-IB.

### 4.1 Interface Configuration

#### 4.1.1 USB Remote Interface

USB Configuration	PC side connector STW-9000 side connector USB Class	Type A, host Rear panel Type A  Virtual COM Port (CP210x:Silicon Laboratories)
Panel operation	<ol style="list-style-type: none"> <li>1. Connect the USB cable to the rear panel USB A port.</li> <li>2. Set the interface to USB from the Common Utility menu.</li> <li>3. When the PC asks for the USB driver, install USB driver from attached CD.</li> <li>4. If the computer can not recognize the new hardware due to the security, please go to update the driver from the "Other devices" in the Device Manager.</li> <li>5. If that does not work properly, please download the latest CP210x VCP driver from .Silicon Laboratories.</li> </ol>	  Page 56
 Note	When USB is used for remote control, an RS-232C port is simulated. An RS-232C setting is fixed (115200bps, 8bit, stop:1bit, Parity:None).	

#### 4.1.2 RS-232C Remote Interface

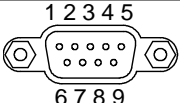
RS-232C Configuration	Connection Baud rate Parity Data bits Stop bit Flow control	Null modem cable 9600, 19200, 38400, 57600, 115200 None 8 1 None																
Pin Assignment		1,4,6,7,8,9: No connection 2: RxD (Receive Data) 3: TxD (Transmit Data) 5: GND																
Connection	<table border="1"> <thead> <tr> <th>DB9 Pin</th> <th>PC Signal</th> <th>STW-9000 Signal</th> <th>DB9Pin</th> </tr> </thead> <tbody> <tr> <td>2</td> <td>RxD</td> <td>TxD</td> <td>3</td> </tr> <tr> <td>3</td> <td>TxD</td> <td>RxD</td> <td>2</td> </tr> <tr> <td>5</td> <td>GND</td> <td>GND</td> <td>5</td> </tr> </tbody> </table>	DB9 Pin	PC Signal	STW-9000 Signal	DB9Pin	2	RxD	TxD	3	3	TxD	RxD	2	5	GND	GND	5	
DB9 Pin	PC Signal	STW-9000 Signal	DB9Pin															
2	RxD	TxD	3															
3	TxD	RxD	2															
5	GND	GND	5															

- Panel operation
1. Connect the Null modem cable to the rear panel RS232 port.
  2. Set the interface to RS232 from the Common Utility menu.

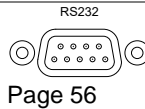

### 4.1.3 GP-IB Remote Interface

GP-IB Configuration	Address	0-30
---------------------	---------	------

- Panel operation
1. Connect the GP-IB cable to the rear panel GP-IB port.
  2. Set the interface to GPIB and set the GPIB address from the Common Utility menu.



## 4.2 USB/RS-232C Remote Control Function Check

Functionality check

Invoke a terminal application such as RealTerm or PuTTY. To check the COM port number and other settings, see the Device Manager in the PC. For Windows Control panel → System → Hardware tab.

Run this query command via the terminal after the instrument has been configured for USB or RS-232C remote control (page 64).

\*idn?

This should return the Model number, Serial number, and Firmware version in the following format:

STW-9xxx, XXXXXXXXXXXXX, V1.00

Model number : STW-9xxx

Serial number :12 character serial number

Firmware version : V1.00

CTRL+j can be used as the terminal character when entering the queries/commands from a terminal application.

Display

When the panel is being remotely controlled via the USB, RS232 or GP-IB interfaces, RMT will be displayed on the screen.

```

MANU=***.002  MANU_002  REF#=00.00mA
FREQ= 60Hz  HI SET=01.00mA
0.100 kV mA
RAMP/τ=000.1S  TIMER=003.2S
ACW  DCW  IR  GB  77
  
```

### 4.3 Return to Panel Control

**Background** When the instrument is remotely controlled all panel keys except the STOP button are disabled.

- Steps**
1. When RMT is on the display, press the STOP button. The panel goes to the READY status.
 

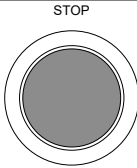

STOP
  
  2. From the READY status the tester can go into one of two states: TEST or VIEW.
    - To put the tester into VIEW status, press the MANU/AUTO key.
 



MANU/AUTO
    - To put the tester in TEST status, press the START button. This will start the manual test/automatic test. For more details on running a manual test or automatic test, see pages 32 and 49, respectively.
 

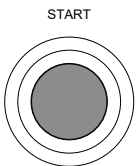

START

 **Note** To put the tester back to RMT, simply issue another remote control command.

### 4.4 Command Syntax

**Compatible Standard** IEEE488.2 Partial compatibility  
SCPI, 1999 Partial compatibility

**Command Structure** SCPI commands follow a tree-like structure, organized into nodes. Each level of the command tree is a node. Each keyword in an SCPI command represents each node in the command tree. Each keyword (node) of an SCPI command is separated by a colon (:).  
For example, the diagram below shows an SCPI sub-structure and a command example.

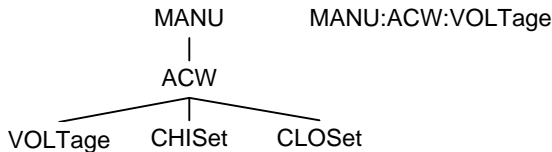

**Command types** There are a number of different instrument commands and queries. A command sends instructions or data to the unit and a query receives data or status information from the unit.  
Command types

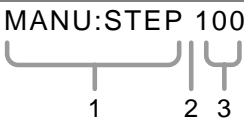
	Setting	A single or compound command with/without a parameter	
	Example	MANU:STEP 1	
	Query	A query is a simple or compound command followed by a question mark (?). A parameter (data) is returned.	
	Example	MANU:ACW:VOLTage?	
Command Forms	<p>Commands and queries have two different forms, long and short. The command syntax is written with the short form of the command in capitals and the remainder (long form) in lower case.</p> <p>The commands can be written in capitals or lower-case, just so long as the short or long forms are complete. An incomplete command will not be recognized.</p> <p>Below are examples of correctly written commands.</p>		
	Long form	SYSTEM:BUZZer:KEYSound SYSTEM:BUZZER:KEYSOUND system:buzzer:keysound	
	Short form	SYST:BUZZ:KEYS syst:buzz:keys	
Command Format	 <p>MANU:STEP 100</p> <p>1            2 3</p>	1. Command header	
		2. Space	
		3. Parameter	
Parameters	Type	Description	Example
	<Boolean>	Boolean logic	0, 1
	<NR1>	integers	0, 1, 2, 3
	<NR2>	decimal numbers	0.1, 3.14, 8.5
	<NR3>	floating point	4.5e-1, 8.25e+1
	<NRf>	any of NR1, 2, 3	1, 1.5, 4.5e-1
	<string>	ASCII text string	TEST_NAME
Message Terminator	CR, LF	Carriage Return, Line feed code	

## 4.5 Command List

---

### System Commands

SYSTem:LCD:CONTRast .....	70
SYSTem:LCD:BRIGhtness .....	70
SYSTem:BUZZer:PSOUND .....	70
SYSTem:BUZZer:FSOUND .....	70
SYSTem:BUZZer:PTIME .....	71
SYSTem:BUZZer:FTIME .....	71
SYSTem:ERRor .....	71
SYSTem:GPIB:VERSion .....	72

### Function Commands

FUNCTion:TEST .....	72
MEASure<x> .....	72
MAIN:FUNCTion .....	73

### Manual Commands

MANU:STEP .....	73
MANU:NAME .....	74
MANU:RTIME .....	74
MANU:EDIT:MODE .....	74
MANU:ACW:VOLTag .....	75
MANU:ACW:CHISet .....	75
MANU:ACW:CLOSet .....	75
MANU:ACW:TTIME .....	76
MANU:ACW:FREQuency .....	76
MANU:ACW:REF .....	76
MANU:ACW:ARCCurrent .....	77
MANU:DCW:VOLTag .....	77
MANU:DCW:CHISet .....	77
MANU:DCW:CLOSet .....	78
MANU:DCW:TTIME .....	78
MANU:DCW:REF .....	79
MANU:DCW:ARCCurrent .....	79
MANU:IR:VOLTag .....	79
MANU:IR:RHISet .....	80
MANU:IR:RLOSet .....	80
MANU:IR:TTIME .....	80
MANU:IR:REF .....	80
MANU:GB:CURRent .....	81
MANU:GB:RHISet .....	81
MANU:GB:RLOSet .....	81
MANU:GB:TTIME .....	81
MANU:GB:FREQuency .....	82
MANU:GB:REF .....	82
MANU:GB:ZEROCHECK .....	82
MANU:UTILity:ARCMode .....	83
MANU:UTILity:PASShold .....	83
MANU:UTILity:FAILmode .....	83

MANU:UTILity:MAXHold .....	83
MANU:UTILity:GROUNDMODE .....	84
MANU<x>:EDIT:SHOW .....	84
Sweep Commands	
SWEEP:DATA:STATus .....	84
SWEEP<X>:DATA:SHOW .....	85
SWEEP:GRAPh:SHOW .....	85
SWEEP :GRAPh:LINE .....	86
SWEEP:STARt:TIME .....	86
Auto Commands	
AUTO<x>:PAGE:SHOW .....	87
AUTO:PAGE:MOVE .....	87
AUTO:PAGE:SWAP .....	87
AUTO:PAGE:SKIP .....	88
AUTO:PAGE:DEL .....	88
AUTO:NAME .....	88
AUTO:EDIT:ADD .....	89
TESTok:RETurn.....	89
Common Commands	
*CLS .....	89
*IDN .....	89
*RMTOFF .....	90

## 4.6 System Commands

### 4.6.1 SYSTem:LCD:CONTRast

Set →  
→ Query

Description	Sets the contrast of the LCD display from 1 (low) to 8 (bright).
Syntax	SYSTem:LCD:CONTRast <NR1>
Query Syntax	SYSTem:LCD:CONTRast?
Parameter/ Return parameter	<NR1> 1~8
Example	SYST:LCD:CONT 5 Sets the display contrast to 5.

### 4.6.2 SYSTem:LCD:BRIGhtness

Set →  
→ Query

Description	Sets the brightness of the LCD display from 1 (dark) to 2 (bright).
Syntax	SYSTem:LCD:BRIGhtness <NR1>
Query Syntax	SYSTem:LCD:BRIGhtness?
Parameter/ Return parameter	<NR1> 1 (dark), 2 (bright)
Example	SYST:LCD:BRIG 2 Sets the display brightness to bright.

### 4.6.3 SYSTem:BUZZer:PSOUND

Set →  
→ Query

Description	Turns the buzzer sound on or off for a PASS judgment.
Syntax	SYSTem:BUZZer:PSOUND{ON OFF}
Query Syntax	SYSTem:BUZZer:PSOUND ?
Parameter/ Return parameter	ON PASS Sound on. OFF PASS Sound off.
Example	SYST:BUZZ:PSOUND ON Turns the buzzer sound on for PASS judgments.

### 4.6.4 SYSTem:BUZZer:FSOUND

Set →  
→ Query

Description	Turns the buzzer sound on or off for a FAIL judgment.
Syntax	SYSTem:BUZZer:FSOUND{ON OFF}
Query Syntax	SYSTem:BUZZer:FSOUND ?
Parameter/ Return parameter	ON FAIL Sound on. OFF FAIL Sound off.
Example	SYST:BUZZ:FSOUND ON Turns the buzzer sound on for FAIL judgments.



#### 4.6.5 SYSTem:BUZZer:PTIME

Set →  
→ Query

Description	Sets the PASS sound duration in seconds.
Syntax	SYSTem:BUZZer:PTIME <NR2>
Query Syntax	SYSTem:BUZZer:PTIME?
Parameter/ Return parameter	<NR2> 0.2~999.9
Example	SYST:BUZZ:PTIM 1 Sets the buzzer to 1 second for a PASS judgment.

#### 4.6.6 SYSTem:BUZZer:FTIME

Set →  
→ Query

Description	Sets the FAIL Sound duration in seconds.
Syntax	SYSTem:BUZZer:FTIME <NR2>
Query Syntax	SYSTem:BUZZer:FTIME?
Parameter/ Return parameter	<NR2> 0.2~999.9
Example	SYST:BUZZ:FTIM 1 Sets the buzzer to 1 second for a FAIL judgment.

#### 4.6.7 SYSTem:ERRor

→ Query

Description	Returns any errors in the output buffer. See the error code table below for details.																				
Query Syntax	SYSTem:ERRor ?																				
Return parameter	<string> Returns an error string that includes an error code and an error description.																				
	<table border="0"> <tr> <td>0, No Error</td> <td>31, Current Setting Error</td> </tr> <tr> <td>20, Command Error</td> <td>32, Current HI SET Error</td> </tr> <tr> <td>21, Volume Error</td> <td>33, Current LOW SET Error</td> </tr> <tr> <td>22, String Error</td> <td>34, Resistance HI SET Error</td> </tr> <tr> <td>23, Query Error</td> <td>35, Resistance HI SET Error</td> </tr> <tr> <td>24, Mode Error</td> <td>36, REF Setting Error</td> </tr> <tr> <td>25, Time Error</td> <td>37, Frequency Setting Error</td> </tr> <tr> <td>26, DC Over 50W</td> <td>38, ARC Setting Error</td> </tr> <tr> <td>27, GBV &gt; 5.4V</td> <td>39, RAMP Time Setting Error</td> </tr> <tr> <td>30, Voltage Setting Error</td> <td>40, TEST Time Setting Error</td> </tr> </table>	0, No Error	31, Current Setting Error	20, Command Error	32, Current HI SET Error	21, Volume Error	33, Current LOW SET Error	22, String Error	34, Resistance HI SET Error	23, Query Error	35, Resistance HI SET Error	24, Mode Error	36, REF Setting Error	25, Time Error	37, Frequency Setting Error	26, DC Over 50W	38, ARC Setting Error	27, GBV > 5.4V	39, RAMP Time Setting Error	30, Voltage Setting Error	40, TEST Time Setting Error
0, No Error	31, Current Setting Error																				
20, Command Error	32, Current HI SET Error																				
21, Volume Error	33, Current LOW SET Error																				
22, String Error	34, Resistance HI SET Error																				
23, Query Error	35, Resistance HI SET Error																				
24, Mode Error	36, REF Setting Error																				
25, Time Error	37, Frequency Setting Error																				
26, DC Over 50W	38, ARC Setting Error																				
27, GBV > 5.4V	39, RAMP Time Setting Error																				
30, Voltage Setting Error	40, TEST Time Setting Error																				
Example	SYST:ERR ? >0, No Error Returns "0, No Error" as the error message.																				

#### 4.6.8 SYSTem:GPIB:VERSion

→ Query

Description	Queries the GP-IB version.
Query Syntax	SYSTem:GPIB:VERSion?
Return parameter	<string> Returns: The GP-IB version as a string "GPIB,V1.00" or "No GPIB connected" if there is not a GP-IB device configured/connected.
Query Example	SYST:GPIB:VERS? >GPIB,V1.00 Returns the GP-IB version.

#### 4.7 Function Commands

##### 4.7.1 FUNCtion:TEST

Set →

→ Query

Description	Turns the currently selected test (output) on or off. When HOLD is displayed on the screen during AUTO tests, use the FUNCtion:TEST command to move on to the next step. Setting the FUNCtion:TEST command to OFF at the end of a test will also temporarily turn the PASS/FAIL buzzer sound off.
Syntax	FUNCtion:TEST {ON OFF}
Query Syntax	FUNCtion:TEST?
Parameter	ON Turns the test on. OFF Turns the test off.
Return parameter	TEST ON Test is on. TEST OFF Test is off.
Example	FUNC:TEST ON Turns the output on.

##### 4.7.2 MEASure<x>

→ Query

Description	Returns the test parameters & results of the tester in either MANU or AUTO mode. MANU mode: Returns the test parameters & results of a MANU test. AUTO mode: Returns the test parameters & results of the selected step (1-16) of the AUTO test. Return parameters: function, judgment/status, test voltage, test current/resistance, test time (time of completed test) or ramp time (elapsed time of test that has not been completed).
Query Syntax	MEASure<x>?

Parameter (MANU mode)		No parameter needed for MANU mode.
Parameter (AUTO mode)	<x>	<NR1>1~16. Step number.
Return parameter	<string>	Returns the test status of the test in the following format: function, judgment or status, test voltage, test current or resistance, test time or ramp time
	Function	ACW, DCW, IR, GB
	Judgment /Status	PASS, FAIL VIEW
	Test voltage	voltage+unit
	Test current /Test resistance	current+unit resistance+unit
	Test time /Ramp time	T=time+S R=time+S
Example (in MANU mode)	MEAS? >ACW, FAIL , 0.024kV ,0.013 mA ,R=000.1S	Returns the test result of the current manual test.
Example (in AUTO mode)	MEAS10? >IR, FAIL ,0.225kV ,999M ohm,T=010.3S	Returns step 10 of the current automatic result.

### 4.7.3 MAIN:FUNCTION

Set →  
→ Query

Description	Changes the mode between AUTO and MANU.	
Syntax	MAIN:FUNCTION {MANU AUTO}	
Query Syntax	MAIN:FUNCTION ?	
Parameter/ Return parameter	MANU	Puts the tester mode to MANU.
	AUTO	Puts the tester mode to AUTO.
Example	MAIN:FUNC MANU Sets the tester to MANU mode.	

## 4.8 Manual Commands

### 4.8.1 MANU:STEP

Set →  
→ Query

Description	Sets the MANU test number.	
Syntax	MANU:STEP <NR1>	
Query Syntax	MANU:STEP?	
Parameter/ Return parameter	<NR1>	0~100.
Example	MANU:STEP 100 Sets the manual test number to 100.	

#### 4.8.2 MANU:NAME

Set →  
 → Query

Description	Sets or returns the test name for the selected manual test. The test must be in MANU mode before this command can be used. Note only alphanumeric characters (A-Z, a-z, 0-9) and the “_” underscore character can be used to set the MANU test name.
Syntax	MANU:NAME <string>
Query Syntax	MANU:NAME?
Parameter/ Return parameter	<string> 10 character string. (first character must be a letter)
Example	MANU:NAME test1 Sets the manual test name to “test1”.

#### 4.8.3 MANU:RTIME

Set →  
 → Query

Description	Sets or returns the Ramp Time for the test in seconds.  Note: A “TIME ERR” will result if the Ramp Time + Test Time is ≥ 240 seconds when the HI SET limit is over 80mA . This applies to the ACW function only.
Syntax	MANU:RTIME <NR2>
Query Syntax	MANU:RTIME?
Parameter/ Return parameter	<NR2> 0.1–999.9 seconds
Example	MANU:RTIM 0.5 Sets the ramp time to half a second.

#### 4.8.4 MANU:EDIT:MODE

Set →  
 → Query

Description	Sets or returns the mode (ACW, DCW, IR) of the selected manual test.
Syntax	MANU:EDIT:MODE {ACW DCW IR GB}
Query Syntax	MANU:EDIT:MODE?
Parameter/ Return parameter	ACW AC Withstand mode DCW DC Withstand mode IR Insulation Resistance mode GB GB mode
Example	MANU:EDIT:MODE ACW Sets the mode to ACW.

#### 4.8.5 MANU:ACW:VOLTage

Set →  
→ Query

Description	Sets or returns the ACW voltage in kV. The test must first be in ACW mode before this command can be used.
Syntax	MANU:ACW:VOLTage <NR2>
Query Syntax	MANU:ACW:VOLTage?
Parameter/ Return parameter	<NR2> 0.100 ~ 5.000 (kV)
Example	MANU:ACW:VOLT 1 Sets the ACW voltage to 1 kV.

#### 4.8.6 MANU:ACW:CHISet

Set →  
→ Query

Description	Sets or returns the ACW HI SET current value in milliamps. The test must first be in ACW mode before this command can be used.
Syntax	MANU:ACW:CHISet <NR2>
Query Syntax	MANU:ACW:CHISet?
Parameter/ Return parameter	<NR2> 0.001 ~ 110.0
Example	MANU:ACW:CHIS 10.0 Sets the ACW HI SET current to 10 mA.

#### 4.8.7 MANU:ACW:CLOSet

Set →  
→ Query

Description	<p>Sets or returns the ACW LO SET current value in milliamps. The LO SET value must be less than the HI SET value. The test must first be in ACW mode before this command can be used.</p> <p>The LO SET range must use the HI SET range. If all the digits in the LO SET range are outside the HI SET range, an error will be produced. All digits outside the HI SET range are ignored and will not be used.</p> <p>For example:            HI SET value: 12.34            LO SET value1: 0.005 → error            LO SET value2: 0.053 → no error</p> <p>In the example above LO SET value1 will produce an error as all digits are outside the range of HI SET. LO SET value2 will not produce an error, but will return 0.05, not 0.053.</p>
Syntax	MANU:ACW:CLOSet<NR2>
Query Syntax	MANU:ACW:CLOSet?

Parameter/ Return parameter	<NR2>	0.000 ~ 109.9
Example	MANU:ACW:CLOS 20.0 Sets the ACW LO SET current to 20 mA.	

#### 4.8.8 MANU:ACW:TTIME

Set →  
 → Query

Description	Sets or returns the ACW test time in seconds. The test must first be in ACW mode before this command can be used.	
	<p>Note: A "TIME ERR" will result if the Ramp Time + Test Time is <math>\geq 240</math> seconds when the HI SET limit is over 80mA. This applies to the ACW function only.</p> <p>In special MANU mode, the TIMER can be turned off.</p>	
Syntax	MANU:ACW:TTIME {<NR2> OFF}	
Query Syntax	MANU:ACW:TTIME?	
Parameter	<NR2> OFF	0.5 ~ 999.9 seconds TIMER OFF (special MANU mode).
Return parameter	<NR2> TIME OFF	0.5 ~ 999.9 seconds TIMER is OFF (special MANU mode).
Example	MANU:ACW:TTIM 1 Sets the ACW test time to 1 second.	

#### 4.8.9 MANU:ACW:FREQUENCY

Set →  
 → Query

Description	Sets or returns the ACW test frequency in Hz. The test must first be in ACW mode before this command can be used.	
Syntax	MANU:ACW:FREQUENCY {50 60}	
Query Syntax	MANU:ACW:FREQUENCY?	
Parameter/ Return parameter	50 60	50 Hz 60 Hz
Example	MANU:ACW:FREQ 50 Sets the ACW test frequency to 50Hz.	

#### 4.8.10 MANU:ACW:REF

Set →  
 → Query

Description	Sets or returns the ACW reference value in mA. The test must first be in ACW mode before this command can be used. The ACW reference value must be less than the HI SET value. The ACW reference value must use the same range as the HI SET value.	
Syntax	MANU:ACW:REF <NR2>	
Query Syntax	MANU:ACW:REF?	
Parameter/ Return parameter	<NR2>	0.000 ~ 109.9

Example MANU:ACW:REF 0.01  
Sets the ACW reference to 0.01 mA.

Set →  
→ Query

#### 4.8.11 MANU:ACW:ARCCurrent

Description Sets or returns the ACW ARC current value in mA. ARC must be enabled before the ARC current can be set. The test must first be in ACW mode before this command can be used.

ARC current uses the same range as the HI SET value. The ARC current is limited to 2X the HI SET value.

Syntax MANU:ACW:ARCCurrent <NR2>

Query Syntax MANU:ACW:ARCCurrent?

Parameter/ Return parameter <NR2> 2.000 ~ 200.0

Example MANU:ACW:ARCC 0.04  
Sets the ACW ARC value to 0.04 mA.

Set →  
→ Query

#### 4.8.12 MANU:DCW:VOLTage

Description Sets or returns the DCW voltage in kV. The test must first be in DCW mode before this command can be used.  
Note: A "DC Over 100W" error will result if the DCW Voltage X HI SET value is > 100 watts.

Syntax MANU:DCW:VOLTage <NR2>

Query Syntax MANU:DCW:VOLTage?

Parameter/ Return parameter <NR2> 0.100 ~ 6.100 (kV)

Example MANU:DCW:VOLT 6  
Sets the DCW voltage to 6 kV.

Set →  
→ Query

#### 4.8.13 MANU:DCW:CHISet

Description Sets or returns the DCW HI SET current value in milliamps. The test must first be in DCW mode before this command can be used.

Note: A "DC Over 100W" error will result if the DCW Voltage X HI SET value is > 100 watts.

Syntax MANU:DCW:CHISet <NR2>

Query Syntax MANU:DCW:CHISet?

Parameter/ Return parameter <NR2> 0.001 ~ 21.0

Example MANU:DCW:CHIS 5  
Sets the DCW CHI SET current to 5mA.

#### 4.8.14 MANU:DCW:CLOSet

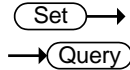

Description	<p>Sets or returns the DCW LO SET current value in milliamps. The LO SET value must be less than the HI SET value. The test must first be in DCW mode before this command can be used.</p> <p>The LO SET range must use the HI SET range. If all the digits in the LO SET range are outside the HI SET range, an error will be produced. All digits outside the HI SET range are ignored and will not be used.</p> <p>For example:            HI SET value: 12.34            LO SET value1: 0.005 → error            LO SET value2: 0.053 → no error</p> <p>In the example above LO SET value1 will produce an error as all digits are outside the range of HI SET. LO SET value2 will not produce an error, but will return 0.05, not 0.053.</p>
Syntax	MANU:DCW:CLOSet<NR2>
Query Syntax	MANU:DCW:CLOSet?
Parameter/ Return parameter	<NR2> 0.000 ~ 20.9
Example	<p>MANU:DCW:CLOS 2.00</p> <p>Sets the DCW LO SET current to 2mA.</p>

#### 4.8.15 MANU:DCW:TTIME

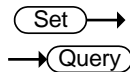

Description	<p>Sets or returns the DCW test time in seconds. The test must first be in DCW mode before this command can be used.</p> <p>In special MANU mode, the TIMER can be turned off.</p>
Syntax	MANU:DCW:TTIME {<NR2> OFF}
Query Syntax	MANU:DCW:TTIME?
Parameter	<p>&lt;NR2&gt; 0.5 ~ 999.9 seconds            OFF TIMER OFF (special MANU mode).</p>
Return parameter	<p>&lt;NR2&gt; 0.5 ~ 999.9 seconds            TIME OFF TIMER is OFF (special MANU mode).</p>
Example	<p>MANU:DCW:TTIM 1</p> <p>Sets the DCW test time to 1 second.</p>



#### 4.8.16 MANU:DCW:REF

Set →  
→ Query

Description	Sets or returns the DCW reference value in mA. The test must first be in DCW mode before this command can be used. The reference value must be less than the HI SET value. The reference value uses the same range as the HI SET value.
Syntax	MANU:DCW:REF <NR2>
Query Syntax	MANU:DCW:REF?
Parameter/ Return parameter	<NR2> 0.000 ~ 20.9
Example	MANU:DCW:REF 0.01 Sets the DCW reference to 0.01 mA.

#### 4.8.17 MANU:DCW:ARCCurrent

Set →  
→ Query

Description	Sets or returns the DCW ARC current value in mA. ARC must be enabled to set the ARC current. The test must first be in DCW mode before this command can be used.  ARC current uses the same range as the HI SET value. The ARC current is limited to 2X the HI SET value.
Syntax	MANU:DCW:ARCCurrent <NR2>
Query Syntax	MANU:DCW:ARCCurrent?
Parameter/ Return parameter	<NR2> 2.000 ~ 40.0
Example	MANU:DCW:ARCC 10 Sets the DCW ARC value to 10mA.

#### 4.8.18 MANU:IR:VOLTage

Set →  
→ Query

Description	Sets or returns the IR voltage in kV. The test must first be in IR mode before this command can be used.
Syntax	MANU:IR:VOLTage <NR2>
Query Syntax	MANU:IR:VOLTage?
Parameter/ Return parameter	<NR2> 0.05 ~ 1 (0.05kV to 1kV: steps of .05)
Example	MANU:IR:VOLT 1 Sets the IR voltage to 1 kV.

#### 4.8.19 MANU:IR:RHISet

Set →  
 → Query

Description	Sets or returns the IR HI SET resistance value. The test must first be in IR mode before this command can be used. Unit of STW-98xx is MΩ, and of STW-99xx is KΩ.		
Syntax	MANU:IR:RHISet <NR2> NULL		
Query Syntax	MANU:IR:RHISet?		
Parameter/ Return parameter	<NR2>	0.002 ~ 50.00 2 ~ 9999	(STW-99xx : GΩ) (STW-98xx : MΩ)
Example	NULL	Sets the HI SET value to high impedance	
Example	MANU:IR:RHIS 0.010 Sets the IR HI SET resistance to 10 MΩ.		

#### 4.8.20 MANU:IR:RLOSet

Set →  
 → Query

Description	Sets or returns the IR LO SET resistance value. The LO SET value must be less than the HI SET value. The test must first be in IR mode before this command can be used. Unit of STW-98xx is MΩ, and of STW-99xx is KΩ.		
Syntax	MANU:IR:RLOSet<NR2>		
Query Syntax	MANU:IR:RLOSet?		
Parameter/ Return parameter	<NR2>	0.001 ~ 50.00 1 ~ 9999	(STW-99xx : GΩ) (STW-98xx : MΩ)
Example	MANU:IR:RLOS 0.010 Sets the IR LO SET resistance to 10MΩ.		

#### 4.8.21 MANU:IR:TTIME

Set →  
 → Query

Description	Sets or returns the IR test time in seconds. The test must first be in IR mode before this command can be used.		
Syntax	MANU:IR:TTIME <NR2>		
Query Syntax	MANU:IR:TTIME?		
Parameter/ Return parameter	<NR2>	1.0 ~ 999.9	seconds
Example	MANU:IR:TTIM 1 Sets the IR test time to 1 second.		

#### 4.8.22 MANU:IR:REF

Set →  
 → Query

Description	Sets or returns the IR reference value. The test must first be in IR mode before this command can be used. The reference value must be lower than the HI SET value. Unit of STW-98xx is MΩ, and of STW-99xx is KΩ.		
Syntax	MANU:IR:REF <NR2>		
Query Syntax	MANU:IR:REF?		

Parameter/ Return parameter	<NR2>	0.000 ~ 50.00 0 ~ 9999	(STW-99xx : GΩ) (STW-98xx : MΩ)
Example	MANU:IR:REF 0.900 Sets the IR reference to 900 MΩ.		

#### 4.8.23 MANU:GB:CURRent

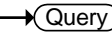
 →  
 → 

Description	Sets or returns the GB current in A. The test must first be in GB mode before this command can be used.		
Syntax	MANU:GB:CURRent <NR2>		
Query Syntax	MANU:GB:CURRent?		
Parameter/ Return parameter	<NR2>	3.00~33.00	
Example	MANU:GB:CURR 3.00 Sets the GB current to 3.00A.		

#### 4.8.24 MANU:GB:RHISet

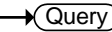
 →  
 → 

Description	Sets or returns the GB HI SET resistance value in mΩ. The test must first be in GB mode before this command can be used.		
Syntax	MANU:GB:RHISet <NR2>		
Query Syntax	MANU:GB:RHISet?		
Parameter/ Return parameter	<NR2>	000.1 ~ 650.0	
Example	MANU:GB:RHIS 100.0 Sets the HI SET value to 100mΩ.		



Note

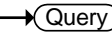

If the (GB current x HI SET resistance) > 5.4V, then an error will be generated ("GBV > 5.4V").

#### 4.8.25 MANU:GB:RLOSet

 →  
 → 

Description	Sets or returns the GB LO SET resistance value in mΩ. The LO SET value must be less than the HI SET value. The test must first be in GB mode before this command can be used.		
Syntax	MANU:GB:RLOSet<NR2>		
Query Syntax	MANU:IR:RLOSet?		
Parameter/ Return parameter	<NR2>	0.000 ~ 649.9	
Example	MANU:GB:RLOS 50 Sets the GB LO SET resistance to 50mΩ.		

#### 4.8.26 MANU:GB:TTIME

 →  
 → 

Description	Sets or returns the GB test time in seconds. The test must first be in GB mode before this command can be used.		
-------------	---	--	--

Syntax	MANU:GB:TTIME <NR2>
Query Syntax	MANU:GB:TTIME?
Parameter/ Return parameter	<NR2> 0.5 ~ 999.9 seconds
Example	MANU:GB:TTIM 1 Sets the GB test time to 1 second.

#### 4.8.27 MANU:GB:FREQuency

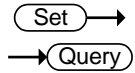

Description	Sets or returns the GB test frequency in Hz. The test must first be in GB mode before this command can be used.
Syntax	MANU:GB:FREQuency {50 60}
Query Syntax	MANU:GB:FREQuency?
Parameter/ Return parameter	50 50 Hz 60 60 Hz
Example	MANU:GB:FREQ 50 Sets the GB test frequency to 50Hz.

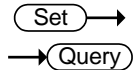

#### 4.8.28 MANU:GB:REF

Description	Sets or returns the GB reference value in mΩ. The test must first be in GB mode before this command can be used.
	The GB reference value must be less than the HI SET value.
Syntax	MANU:GB:REF <NR2>
Query Syntax	MANU:GB:REF?
Parameter/ Return parameter	<NR2> 0.000 ~ 649.9
Example	MANU:GB:REF 100 Sets the GB reference to 100 mΩ.

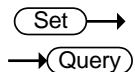

#### 4.8.29 MANU:GB:ZEROCHECK

Description	Performs the zero check function. The test must first be in GB mode and in the Ready Status before this command can be used. See page 39 for details on the ZERO function.
Syntax	MANU:GB:ZEROCHECK {ON OFF}
Query Syntax	MANU:GB:ZEROCHECK?
Parameter/ Return parameter	ON Zero function is active. OFF Zero function is not active.
Example	MANU:GB:ZEROCHECK OFF Activates the ZERO function.

#### 4.8.30 MANU:UTILity:ARCMode

Set →  
→ Query

Description	Sets or returns the ARC mode status for the current test. The ARC mode cannot be set for the IR and GB function.
Syntax	MANU:UTILity:ARCMode {OFF ON_CONT  ON_STOP}
Query Syntax	MANU:UTILity:ARCMode?
Parameter/ Return parameter	OFF Turns ARC mode off. ON_CONT Sets ARC mode to ON and CONTINUE. ON_STOP Sets ARC mode to ON and STOP.
Example	MANU:UTIL:ARCM OFF Turns ARC mode OFF.

#### 4.8.31 MANU:UTILity:PASShold

Set →  
→ Query

Description	Sets or returns the PASS HOLD setting for the current test.
Syntax	MANU:UTILity:PASShold {ON OFF}
Query Syntax	MANU:UTILity:PASShold?
Parameter/ Return parameter	OFF Turns PASS HOLD off. ON Turns PASS HOLD on.
Example	MANU:UTIL:PASS OFF Turns PASS HOLD OFF.

#### 4.8.32 MANU:UTILity:FAILmode

Set →  
→ Query

Description	Sets or returns the FAIL mode setting for the current test.
Syntax	MANU:UTILity:FAILmode {CONT HOLD STOP}
Query Syntax	MANU:UTILity:FAILmode?
Parameter/ Return parameter	CONT Sets/returns the fail mode as continue. HOLD Sets/returns the fail mode as hold. STOP Sets/returns the fail mode as stop.
Example	MANU:UTIL:FAIL CONT Sets the fail mode to CONT (continue).

#### 4.8.33 MANU:UTILity:MAXHold

Set →  
→ Query

Description	Sets or returns the MAX HOLD setting for the current test.
Syntax	MANU:UTILity:MAXHold {ON OFF}
Query Syntax	MANU:UTILity:MAXHold?
Parameter/ Return parameter	OFF Turns MAX HOLD off. ON Turns MAX HOLD on.
Example	MANU:UTIL:MAXH ON Turns MAX HOLD on.

#### 4.8.34 MANU:UTILity:GROUNDMODE

Set →  
 → Query

Description	Sets or returns the Grounding mode of the current test. The Ground Mode setting cannot be turned on with the IR and GB function.
Syntax	MANU:UTILity:GROUNDMODE {ON OFF}
Query Syntax	MANU:UTILity:GROUNDMODE?
Parameter/ Return parameter	OFF Turns ground mode off. ON Turns ground mode on.
Example	MANU:UTIL:GROUNDMODE ON Turns GROUND MODE on.

#### 4.8.35 MANU<x>:EDIT:SHOW

→ Query

Description	Returns the test parameters of a manual test.
Query Syntax	MANU<x>:EDIT:SHOW?
Parameter	<x> <NR1> 000~100. Manual test number
Return parameter	<string> Returns a string in the following format: Test function, test voltage, HI SET value, LO SET value, Ramp time, test time.
Example	MANU1:EDIT:SHOW ? >ACW,0.100kV,H=01.00mA,L=00.00mA,R=000.1S,T=001.0S Returns the test parameters of manual test number 1.

### 4.9 Sweep Commands

#### 4.9.1 SWEEP:DATA:STATus

→ Query

Description	Returns the sweep mode, the voltage and current settings and the number data points that are used in the last sweep. There can be a maximum of 190 data points, depending on the testing time. The data is returned as a string in the following format: SWEEP MODE,VSET,ISET,Get Data[#data points].
Query Syntax	SWEEP:DATA:STATus?
Return parameter	<string> SWEEP MODE, VSET+unit, ISET+units, Get Data=number of data points
Example	SWEEP:DATA:STATus? >ACW,V=0.108kV,HI=10.96 mA ,Get Data=011

#### 4.9.2 SWEEP<X>:DATA:SHOW

→ Query

**Description** Returns the data associated with a sweep graph. Data can be returned in one of two ways; either all the data can be returned or only the data at a particular point in time. The test points are evenly distributed. There can be up to 190 data points. If only the data from a single point is returned then the data is returned in the following format\*:  
 DATA POINT, VSET, ISET, TIME, CR+LF  
 If the all the data for the all the points is returned then the data is returned in the following format\*:  
 ACW MODE,CR+LF  
 No.,V(kV),I(mA), T(S) ,CR+LF  
 001,0.071,0.032,0000.1,CR+LF  
 002,0.111,0.047,0000.2,CR+LF  
 .....  
 013,0.601,0.215,0001.3,CR+LF  
 END

\*Where CR+LF is a carriage return and line feed code. Time is in seconds.

<b>Query Syntax</b>	SWEEP<X>:DATA:SHOW?
<b>Parameter</b>	<X> 1~190 (single data point) 0 (all data points)
<b>Single Data Point Example</b>	SWEEP10:DATA:SHOW? > 010,0.106,00.00,0001.0, CR+LF Returns the data at point 10, which is at the 1 second time for the sweep test.
<b>All Data Points Example</b>	SWEEP0:DATA:SHOW? >ACW MODE,CR+LF >No.,V(kV),I(mA), T(S) ,CR+LF >001,0.071,0.032,0000.1,CR+LF >002,0.111,0.047,0000.2,CR+LF >..... >013,0.601,0.215,0001.3,CR+LF >END This will return all the data from the sweep graph.

Set →

#### 4.9.3 SWEEP:GRAPH:SHOW

→ Query

<b>Description</b>	Turns the sweep graph on or off on the STW-9000 display.
<b>Syntax</b>	SWEEP:GRAPH:SHOW {ON OFF}
<b>Query Syntax</b>	SWEEP:GRAPH:SHOW?
<b>Parameter/ Return parameter</b>	ON Turn the sweep graph on. OFF Turn the sweep graph off.

Example SWEEP:GRAP:SHOW ON  
Displays the sweep graph on the LCD display.

Set →  
→ Query

#### 4.9.4 SWEEP :GRAPh:LINE

Description	Sets or returns which lines are shown on the sweep graph.	
Syntax	SWEEP:GRAPh:LINE <NR1>	
Query Syntax	SWEEP:GRAPh:LINE?	
Parameter/ Return parameter	<NR1>	Description
	0	Turn all lines off/all lines are off.
	1	Displays the graph line for the primary test item. See page 41 for details. For example: V for ACW, DCW and GB tests, I for IR tests.
	2	Displays the graph line for the secondary test items. For example: I for ACW and DCW tests, R for IR and GB tests.
	3	Turn all lines on/all lines are on.

Example SWEEP:GRAP:LINE 3  
Turns all the graph lines on.

Set →  
→ Query

#### 4.9.5 SWEEP:STARt:TIME

Description	Sets or returns the start time (STA.t) of the sweep graph in milliseconds. This setting will also set what the time for first point will be for the sweep data that is returned in the SWEEP:DATA:SHOW query.	
Syntax	SWEEP:STARt:TIME <NR2>	
Query Syntax	MANU:RTIME?	
Parameter/ Return parameter	<NR2>	0.1~1999.8 milliseconds
Example	SWEEP:STARt:TIME 100.0 Sets the sweep start time to 1 second.	

### 4.10 Auto Commands

#### 4.10.1 AUTO:STEP

Set →  
→ Query

Description	Sets or queries the AUTO number (automatic test number).	
Syntax	AUTO:STEP <NR1>	
Query Syntax	AUTO:STEP?	
Parameter/ Return parameter	<NR1>	1~100.
Example	AUTO:STEP 100 Sets the current AUTO number to 100.	



#### 4.10.2 AUTO<x>:PAGE:SHOW

→ Query

Description	Returns the Page View of the selected automatic test in the following format: step1:MANU number, step2: MANU number, step3....etc.
Query Syntax	AUTO<x>:PAGE:SHOW?
Parameter/	<x>      <NR1> 1~100
Example	AUTO1:PAGE:SHOW? >01:011 ,02:004 ,03:003 ,04:014 , >05:015 ,06:020* ,07:012 ,08:018 , >09: ,10: ,11: ,12: , >13: ,14: ,15: ,16: , Shows the Page View for AUTO number 1.

#### 4.10.3 AUTO:PAGE:MOVE

Set →

Description	Moves the source step to the desired destination.
Syntax	AUTO:PAGE:MOVE <Value1>,<Value2>
Parameter/	<Value1> <NR1> 1~16 (source step) <Value2> <NR1> 1~16 (destination step)
Example	AUTO:PAGE:MOVE 1, 4 Moves the contents of step 1 to the step 4.

```

AUTO=001-010 AUTO_NAME
MANU_NAME ACW=0.100kV HI_SET=01 VMA
#01:010 #02:001 #03:003 #04:004
#05:007 #06:003 #07:038 #08:005
#09: #10: #11: #12:
#13: #14: #15: #16:
MOVE SWAP SKIP DEL
    
```

#### 4.10.4 AUTO:PAGE:SWAP

Set →

Description	Swaps the source step with destination step.
Syntax	AUTO:PAGE:SWAP <Value1>,<Value2>
Parameter/	<Value1> <NR1> 1~16 (source step) <Value2> <NR1> 1~16 (destination step)
Example	AUTO:PAGE:SWAP 1, 4 Swaps the contents of step 1 with step 4.

```

AUTO=001-010 AUTO_NAME
MANU_NAME ACW=0.100kV HI_SET=01 VMA
#01:010 #02:001 #03:003 #04:004
#05:007 #06:003 #07:038 #08:005
#09: #10: #11: #12:
#13: #14: #15: #16:
MOVE SWAP SKIP DEL
    
```

#### 4.10.5 AUTO:PAGE:SKIP

Set →

Description	Skips the selected step when an AUTO test is run. This is shown as an asterisk (*) when in the PAGE view.
Syntax	AUTO:PAGE:SKIP <NR1>,{(ON OFF)}
Parameter/	<NR1> 1~16 (step no.) ON Skip the selected step. OFF Un-skip the selected step.
Example	AUTO:PAGE:SKIP 1,ON Skips step number #1. <pre>AUTO=001-010 AUTO_NAME MANU_NAME ACW=0.100kV HI SET=01.00mA #01:010 #02:001 #03:003 #04:004 #05:007 #06:003 #07:038 #08:005 #09: #10: #11: #12: #13: #14: #15: #16: MOVE SWAP SKIP DEL</pre>

#### 4.10.6 AUTO:PAGE:DEL

Set →

Description	Deletes the selected step from the AUTO test. The remaining steps move up to replace the deleted step.
Syntax	AUTO:PAGE:DEL <NR1>
Parameter/	<NR1> 1~16 (step no.)
Example	AUTO:PAGE:DEL 3 Deletes the contents of step number #3. <pre>AUTO=001-010 AUTO_NAME MANU_NAME ACW=0.100kV HI SET=01.00mA #01:010 #02:001 #03:003 #04:004 #05:007 #06:003 #07:038 #08:005 #09: #10: #11: #12: #13: #14: #15: #16: MOVE SWAP SKIP DEL</pre>

#### 4.10.7 AUTO:NAME

Set →

→ Query

Description	Sets or returns the AUTO name for the selected automatic test. The test must be in AUTO mode before this command can be used.  Note only alphanumeric characters (A-Z, a-z, 0-9) and the “_” underscore character can be used to set the AUTO test name.
Syntax	AUTO:NAME <string>
Query Syntax	AUTO:NAME?
Parameter/ Return parameter	<string> 10 character string. (first character must be a letter)
Example	AUTO:NAME program1 Sets the AUTO name to “program1”.

### 4.10.8 AUTO:EDIT:ADD

Set →

Description	Add the selected MANU test to the current AUTO number.
Syntax	AUTO:EDIT:ADD <NR1>
Parameter/	<NR1> 1~100
Example	AUTO:EDIT:ADD 7 Adds MANU-007 to the current AUTO number. I.e.,

```
AUTO=005-007 AUTO_NAME
MANU_NAME ACW=0.100kV HI_SET=01.00mA
#01:010 #02:001 #03:003 #04:004
#05:007 #06: #07: #08:
#09: #10: #11: #12:
#13: #14: #15: #16:
MOV SWAP SKIP DEL
```

MANU test added to last step

### 4.10.9 TESTok:RETurn

Set →  
→ Query

Description	Allows “OK” to be displayed on the remote terminal when a test has stopped (PASS/FAIL or STOP). This applies for MANU and AUTO mode. By default, TESTok:RETurn is set to OFF.
Syntax	TESTok:RETurn {ON OFF}
Query Syntax	TESTok:RETurn?
Parameter/ Return parameter	ON Enables the “OK” message to be displayed. OFF Disables the message
Example	TEST:RET OFF Disables the message.

## 4.11 Common Commands

### 4.11.1 \*CLS

Set →

Description	The *CLS command clears the internal registers.
Syntax	*CLS

### 4.11.2 \*IDN

→ Query

Description	Queries the model number, serial number, and firmware version of the tester.
Query Syntax	*IDN?
Return parameter	<string> Returns the instrument identification as a string in the following format: STW-9901, XXXXXXXXXXXXX, V1.00 (Model / Serial number / version)

### 4.11.3 \*RMTOFF



---

Description	This command can be used to terminate a remote session. When this command is used "RMT" will no longer be displayed on the front panel, indicating that remote mode has been terminated.
Syntax	*RMTOFF

---

## 4.12 Error Messages

---

Background            The possible error messages returned from SYST:ERR? query are listed below.

---

Error	Error Code
No Error	0
Command Error	20
Volume Error	21
String Error	22
Query Error	23
Mode Error	24
Time Error	25
DC Over 50W	26
GBV > 5.4V	27
Voltage Setting Error	30
Current Setting Error	31
Current HI SET Error	32
Current LOW SET Error	33
Resistance HI SET Error	34
Resistance HI SET Error	35
REF Setting Error	36
Frequency Setting Error	37
ARC Setting Error	38
RAMP Time Setting Error	39
TEST Time Setting Error	40

## 5. FAQ

### 5.1 The tester will not turn on.

---

Ensure the power cord is connected. Ensure the line input is set to the correct line voltage. Check to make sure the fuse is not blown. See page 93.

### 5.2 The panel keys are not working.

---

Ensure the tester is not in remote mode, page 66.

Ensure the tester is not in SIGNAL I/O or Remote Connect mode, page 57.

### 5.3 When I press the START button the tester will not start testing?

---

The tester must first be in the READY status before a test can be started. Ensure the tester displays READY before pressing the START button, page 32 (manual test), 49(automatic test).

If “Double Action” is enabled, the START button must be pressed 0.5 seconds after the STOP button is pressed, otherwise the tester will not start testing.

If “Interlock” is enabled, the interlock key must be inserted into the signal I/O port on the rear before a test can be started. See page 62 for details.

Lastly, ensure that the Start Ctrl setting is correctly configured in the Common Utility menu. For example, to enable the START button to start a test, ensure that the Start Ctrl setting is set to FRONT PANEL. See page 58 for details.

### 5.4 The accuracy does not match the specification.

---

Make sure the tester is powered on for at least 30 minutes, within +15°C~+35°C. This is necessary to stabilize the unit to match the specification.

For more information, contact your local dealer or TEXIO at [www.texio.co.jp/](http://www.texio.co.jp/)  
[info@texio.co.jp](mailto:info@texio.co.jp)

## 6. APPENDIX

### 6.1 Fuse Replacement

Steps

1. Turn the instrument off.

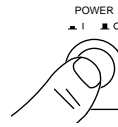

2. Remove the power cord.

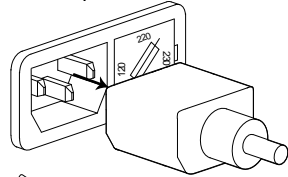

3. Remove the fuse socket using a flat screwdriver.

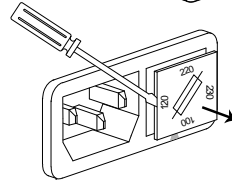

4. Replace the fuse in the fuse holder.

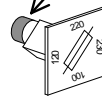

5. Ensure the correct line voltage is lined up with the arrow on the fuse holder. Insert the fuse socket.

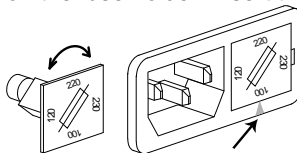

Rating

	STW-9900	STW-9800
100V/120V	T10A 250V	T5A 250V
220V/230V	T6.3A 250V	T2.5A 250V

## 6.2 Error Messages

### 6.2.1 System Self-Test

The following error messages or messages may appear on the STW screen during the Start-Up initialization. If any of these error messages appear on the STW-9000, please see an authorized TEXIO distributor.

Error Messages	Description
0x11	EEPROM1 Error
0x12	EEPROM1 Error
0x21	W-V Offset Error (W-V: ACW/DCW voltage)
0x22	W-I Offset Error (W-I: ACW/DCW current)
0x23	IR-I Offset Error
0x24	GB-I Offset Error

### 6.2.2 Test Errors

The following error messages or messages may appear on the STW screen when configuring or running tests.

Error Messages	Description
TIME ERR	TIME ERR is displayed For ACW tests. STW-9900: HI SET $\geq$ 80.00mA~100.0mA RAMP $\nearrow$ time + TEST TIME setting is > 240 sec STW-9800: HI SET $\geq$ 30.00mA~40.0mA RAMP $\nearrow$ time + TEST TIME setting is > 240 sec
OVER 100W (STW-9900)	For DCW tests. OVER 100W is displayed if the HI SET setting multiplied by the Voltage setting is greater than 100W
OVER 50W (STW-9800)	For DCW tests. OVER 50W is displayed if the HI SET setting multiplied by the Voltage setting is greater than 50W
I ERR	For ACW, DCW tests. Shown when the current is set too high.
SHORT	Voltage is too low or there is no High Voltage output. Indicates that the DUT could be shorted.
V ERR	For ACW, DCW tests. Indicates that an abnormal voltage has been detected.
V = 0	For GB tests. Voltage is equal to 0. Check to see that the SENSE H or SOURCE H is not open.
R ERR	For IR tests. The voltage is too high or resistance=0 $\Omega$ . Check to see whether the DUT or test lead is shorting. For GB tests. The resistance is too high.



I < SET	For GB tests. Current too low. Indicates that the SOURCE L or SOURCE H test lead is open or poorly connected. Test the test lead connection with the DUT to confirm.
I > SET	For GB tests. Current is too high.
R = 0	For GB tests. Resistance = 0. This error indicates that there is an error with the measured resistance (0Ω). Perform the zeroing function again.

### 6.3 STW-9000 Specifications

The specifications apply when the STW-9000 is powered on for at least 30 minutes at 15°C~35°C.

#### 6.3.1 Specifications

##### Environment

Range	Temperature	Humidity
Warranty	15°C ~ 35°C	≤70% (No condensation)
Operation	0°C ~ 40°C	≤70% (No condensation)
Storage	-10°C ~ 70°C	≤85% (No condensation)
Installation Location	Indoors at an amplitude of up to 2000m.	

##### AC Withstanding Voltage

Output Voltage Range	0.100kV~ 5.000kV	
Output Voltage Resolution	2V	
Output Voltage Accuracy	± (1% of setting +5V) with no load	
Maximum Rated Load (Table1)	STW-9800:	200 VA (5kV/ 40mA)
	STW-9900:	500 VA (5kV/100mA)
Maximum Rated Current	STW-9800:	40mA
		0.001mA ~ 10mA(0.1kV≤V≤0.5kV) 0.001mA ~ 40mA(0.5kV<V≤5kV)
	STW-9900:	100mA
		0.001mA ~ 10mA(0.1kV≤V≤0.5kV) 0.001mA ~ 100mA(0.5kV<V≤5kV)
Output Voltage Waveform	Sine wave	
Frequency	50 Hz / 60 Hz	
Voltage Regulation	± 1% +5V [Maximum rated load → no load]	
Voltmeter Accuracy	± (1% of reading+ 5V)	
Current Measurement Range	STW-9800:	0.001mA~40.0mA
	STW-9900:	0.001mA~100.0mA
Current Best Resolution	STW-9800:	1uA
		0.001mA (0.001mA~1.100mA)
		0.01mA (01.11mA~11.00mA)
	0.1mA (011.1mA~040.0mA)	
	STW-9900:	1uA
		0.001mA (0.001mA~1.100mA)
0.01mA (01.11mA~11.00mA)		
0.1mA (011.1mA~100.0mA)		

Current Measurement Accuracy	STW-9800: $\pm (1.5\% \text{ of rdg} + 30 \text{ counts})$ :HI SET < 1.11mA $\pm (1.5\% \text{ of rdg} + 3 \text{ counts})$ :HI SET $\geq$ 1.11mA
	STW-9900: $\pm (1.5\% \text{ of rdg} + 30 \text{ counts})$ :HI SET < 1.11mA $\pm (1.5\% \text{ of rdg} + 3 \text{ counts})$ :HI SET $\geq$ 1.11mA

Window Comparator Method	Yes
ARC DETECT	Yes
Rise-time Control Function	Yes
RAMP (Ramp Time)	0.1s~999.9s
TIMER (Test Time)	OFF*, 0.5s~999.9s
GND	ON/OFF

\* The timer can only be turned off under special MANU mode (MANU=\*\*\*-000)

### DC Withstanding Voltage

Output Voltage Range	0.100kV~ 6.000kV
Output Voltage Resolution	2V
Output Voltage Accuracy	$\pm (1\% \text{ of setting} + 5V)$ with no load
Maximum Rated Load (Table1)	STW-9800: 50W(5kV/10mA) STW-9900: 100W (5kV/20mA)
Maximum Rated Current	STW-9800: 10mA 0.001mA ~ 2mA (0.1kV $\leq$ V $\leq$ 0.5kV) 0.001mA ~ 10mA (0.5kV < V $\leq$ 6kV) STW-9900: 20mA 0.001mA ~ 2mA (0.1kV $\leq$ V $\leq$ 0.5kV) 0.001mA ~ 20mA (0.5kV < V $\leq$ 6kV)

Voltmeter Accuracy	$\pm (1\% \text{ of reading} + 5V)$
Voltage Regulation	$\pm 1\% + 5V$ [Maximum rated load $\rightarrow$ no load]
Current Measurement Range	STW-9800: 0.001mA ~ 010.0mA STW-9900: 0.001mA ~ 020.0mA

Current Best Resolution	STW-9800: 1uA 0.001mA (0.001mA~1.100mA) 0.01mA (01.00mA~11.00mA) STW-9900: 1uA 0.001mA (0.001mA~1.100mA) 0.01mA (01.11mA~11.00mA) 0.1mA (011.0mA~020.0mA)
-------------------------	---

Current Measurement Accuracy	STW-9800: $\pm (1.5\% \text{ of rdg} + 30 \text{ counts})$ :HI SET < 1.11mA $\pm (1.5\% \text{ of rdg} + 3 \text{ counts})$ :HI SET $\geq$ 1.11mA
	STW-9900: $\pm (1.5\% \text{ of rdg} + 30 \text{ counts})$ :HI SET < 1.11mA $\pm (1.5\% \text{ of rdg} + 3 \text{ counts})$ :HI SET $\geq$ 1.11mA

Window Comparator Method	Yes
ARC DETECT	Yes
Rise-time Control Function	Yes
RAMP (Ramp Time)	0.1s~999.9s

TIMER (Test Time)	OFF*, 0.5s~999.9s
GND	ON/OFF

\* The timer can only be turned off under special MANU mode (MANU=\*\*\*-000)

### Insulation Resistance Test

Output Voltage	50V~1000V	
Output Voltage Resolution	50V	
Output Voltage Accuracy	(1% of setting+5V) with no load	
Resistance Measurement Range	STW-9800: 1M $\Omega$ ~9500M $\Omega$ STW-9900: 1M $\Omega$ ~50G $\Omega$	
Test Voltage		
STW-9800:	Measurement Range	Accuracy
50V $\leq V \leq 450V$	1~50M $\Omega$	$\pm$ (5% of reading +1 count)
	51~2000M $\Omega$	$\pm$ (10% of reading +1 count)
500V $\leq V \leq 1000V$	1~500M $\Omega$	$\pm$ (5% of reading +1 count)
	501~9500M $\Omega$	$\pm$ (10% of reading +1 count)
STW-9900	Measurement Range	Accuracy
50V $\leq V \leq 450V$	1~50M $\Omega$	$\pm$ (5% of reading +1 count)
	51~2000M $\Omega$	$\pm$ (10% of reading +1 count)
500V $\leq V \leq 1000V$	0.001G $\Omega$ ~0.500G $\Omega$	$\pm$ (5% of reading +1 count)
	0.501G $\Omega$ ~9.999G $\Omega$	$\pm$ (10% of reading +1 count)
	10.00G $\Omega$ ~50.00G $\Omega$	$\pm$ (20% of reading +1 count)
Output Impedance	600k $\Omega$	
Window Comparator Method	Yes	
Rise-time Control Function	Yes	
RAMP (Ramp Time)	0.1s~999.9s	
TIMER (Test Time)	1s~999.9s	
GND	OFF	

### Ground Bond Test(STW-9904)

Output Current Range	03.00A~32.00A	
Output Current Accuracy	$\pm$ (1% of reading +0.2A)	when 3A $\leq I \leq$ 8A
	$\pm$ (1% of reading +0.05A)	when 8A < I $\leq$ 32A
Output Current Resolution	0.01A	
Frequency	50Hz/60Hz selectable	
Ohmmeter Measurement Accuracy	$\pm$ (1% of reading +2m $\Omega$ )	
Ohmmeter Measurement Range	10m $\Omega$ ~650.0m $\Omega$ (depending on output current)	

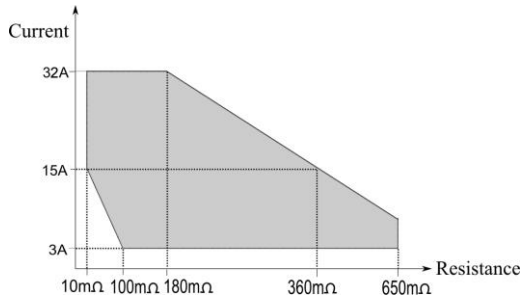

Test Voltage	Max. 6V(AC)open - circuit
Ohmmeter Measurement Resolution	0.1mΩ
Windows Comparator Method	Yes
TIMER (Test Time)	0.5s~999.9s
GND	OFF

### Interface

REMOTE (Remote terminal)	Yes
SIGNAL IO	Yes
RS-232C	Yes
USB (Device)	Yes
GP-IB	Yes (OPTION)

### General

DISPLAY	240 x 64 dot matrix LED back light LCD
MEMORY	AUTO/MANU mode 100 memory blocks total
POWER SOURCE	AC100V/120V/220V/230V ±10% 50Hz/60Hz
ACCESSORIES	Power cord x1 User Manual x1 (CD) GHT-114 x1 GTL-115 x1 for STW-9904

DIMENSIONS & WEIGHT	STW-9901/9902/9903:	
	330(W)×148(H)×482(D)mm(Max)	24kg(Max)
	STW-9904:	
	330(W)×148(H)×593.7(D)mm(Max)	27kg(Max)
	STW-9801/9802/9803:	
	330(W)×148(H)×452(D) mm (Max)	19kg(Max)

---

**Table 1: Output Limitation in Withstanding Voltage Testing**

STW-9800	Upper Current	Pause	Output Time
AC	$30\text{mA} \leq I \leq 40\text{mA}$	At least as long as the output time	Maximum 240 seconds
	$0.001\text{mA} \leq I < 30\text{mA}$	Not necessary	Continuous output possible
DC	$0.001\text{mA} \leq I \leq 10\text{mA}$	Not necessary	Continuous output possible

---

STW-9900	Upper Current	Pause	Output Time
AC	$80\text{mA} \leq I \leq 100\text{mA}$	At least as long as the output time	Maximum 240 seconds
	$0.001\text{mA} \leq I < 80\text{mA}$	Not necessary	Continuous output possible
DC	$0.001\text{mA} \leq I \leq 20\text{mA}$	Not necessary	Continuous output possible
GB	$15\text{A} < I \leq 32\text{A}$		Maximum 999.9 seconds
	$3\text{A} \leq I \leq 15\text{A}$	Not necessary	Maximum 999.9 seconds

NOTE: Output Time = Ramp Time + Test Time.

---

## 6.4 Dimensions

### 6.4.1 STW-9801/9802/9803 Dimensions

---

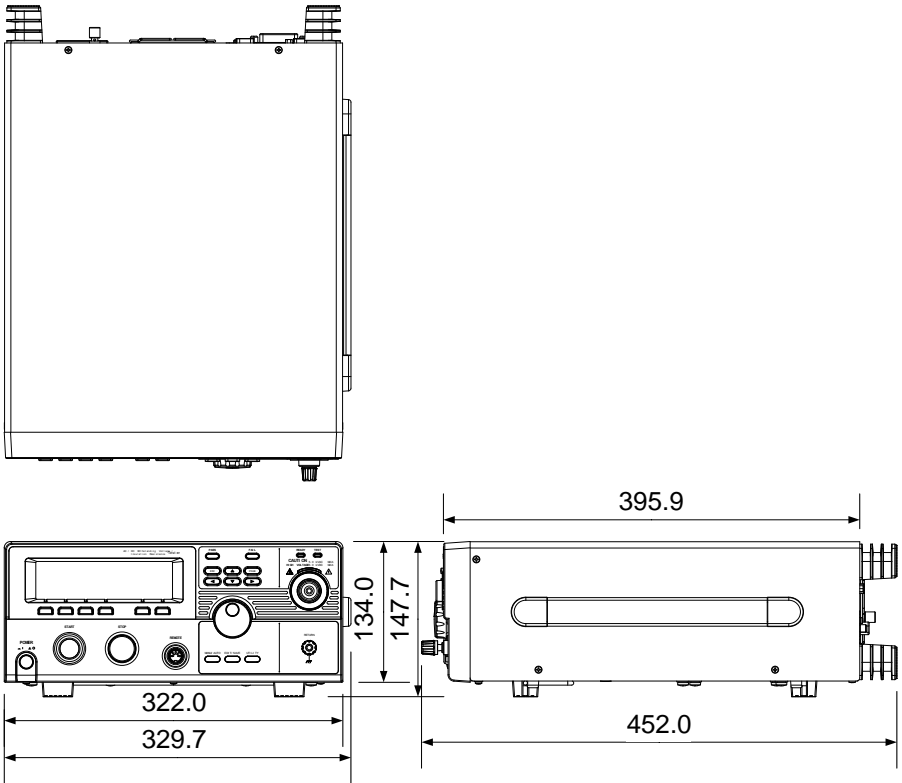

## 6.4.2 STW-9901/9902/9903 Dimensions

---

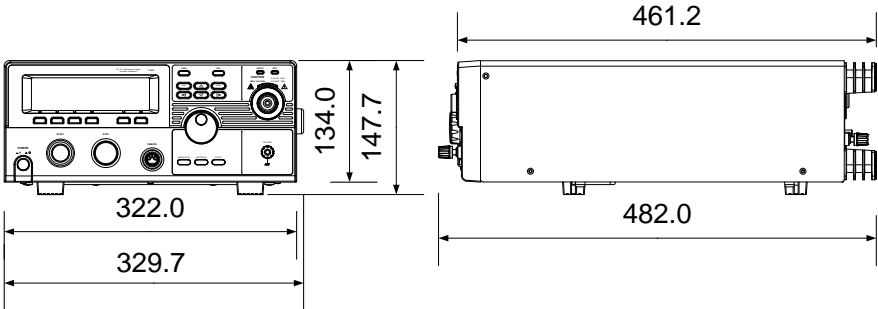
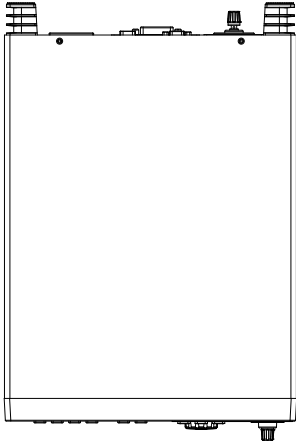

### 6.4.3 STW-9904 Dimensions

---

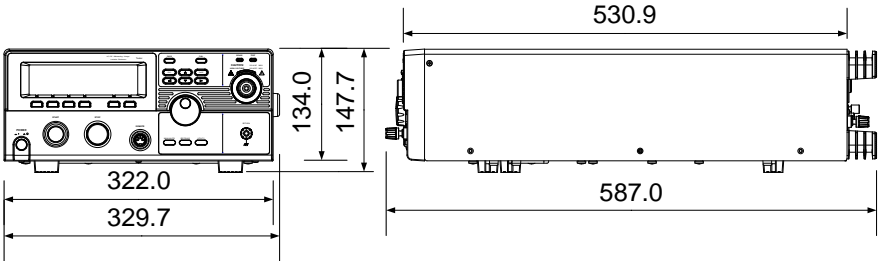
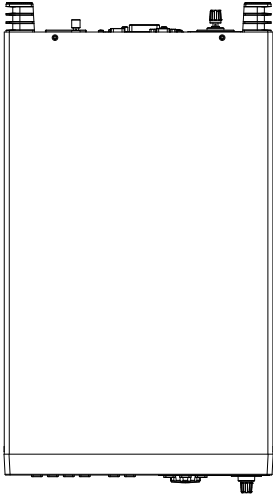





**TEXIO TECHNOLOGY CORPORATION**

7F Towa Fudosan Shin Yokohama Bldg.  
2-18-13, Shin Yokohama, Kohoku-ku, Yokohama, Kanagawa, 222-0033 Japan  
<https://www.texio.co.jp/>

---