

INSTRUCTION MANUAL

WIDE RANGE DC POWER SUPPLY PFR-100 SERIES

PFR-100L50
PFR-100L50G
PFR-100L50N

PFR-100M250
PFR-100M250G
PFR-100M250N



■ About Brands and Trademarks

“TEXIO” is the product brand name of our industrial electronic devices.

All company names and product names mentioned in this manual are the trademark or the registered trademark of each company or group in each country and region.

■ About the Instruction Manual

The latest version of the instruction manual is posted on our website (<https://www.texio.co.jp/download/>).

In order to be environmentally friendly and reduce waste, we are gradually discontinuing the use of paper or CD manuals that come with our products. Even if there is a description in the instruction manual that the product is included, it may not be included.

CONTENTS

USING THE PRODUCT SAFELY I -IV

1. GETTING STARTED 1

1-1. PFR-100 Series Overview.....	1
1-1-1. Series lineup.....	1
1-1-2. Main Features.....	1
1-1-3. Accessories.....	2
1-2. Appearance.....	3
1-2-1. Front Panel.....	3
1-2-2. Rear Panel.....	5
1-3. Theory of Operation.....	7
1-3-1. Operating Area Description.....	7
1-3-2. CC and CV Mode.....	8
1-3-3. Slew Rate.....	9
1-3-4. Bleeder Control.....	9
1-3-5. Sink Current Table.....	10
1-3-6. Alarms.....	11
1-3-7. Considerations.....	11
1-3-8. Grounding.....	13

2. OPERATION 15

2-1. Set Up.....	15
2-1-1. Power up.....	15
2-1-2. Wire Gauge Considerations.....	15
2-1-3. The Rear Panel Output Terminal.....	16
2-1-4. The Front Panel Output Terminal.....	17
2-1-5. Using the Output Terminal Cover.....	18
2-1-6. Using the Rack Mount Kit.....	19
2-1-7. How to Use the Instrument.....	19
2-1-8. Reset to Factory Default Settings.....	20
2-1-9. View System Version and Build Date.....	21
2-2. Basic Operation.....	23
2-2-1. Setting OVP/OCP/UVL Levels.....	23
2-2-2. Set to CV Mode.....	25
2-2-3. Set to CC Mode.....	27
2-2-4. Display Modes.....	29
2-2-5. Panel Lock.....	29
2-2-6. Preset Memory.....	30
2-2-7. Remote Sensing.....	31
2-3. Test Script.....	33
2-3-1. Test Script File Format.....	33
2-3-2. Test Script Settings.....	33
2-3-3. Setting the Test Script.....	33
2-3-4. Load Test Script from USB drive.....	34
2-3-5. Run Test Script.....	35
2-3-6. Export Test Script to USB.....	36
2-3-7. Remove Test Script.....	37
2-3-8. Checking the Available Memory.....	37

2-3-9. Data structure of the Test Script.....	37
2-3-10. Setting values of the test Script.....	38
3. CONFIGURATION	40
3-1. Configuration Table	40
3-2. Normal Function Settings	43
3-3. USB / GP-IB Settings	45
3-4. LAN Settings	45
3-5. UART Settings	46
3-6. System Settings	46
3-7. Power On Configuration Settings	47
3-8. Special Function.....	47
3-9. Setting Normal Function Settings.....	48
3-10. Setting Power On Configuration Settings	49
4. ANALOG CONTROL	50
4-1. Analog Remote Control Overview.....	50
4-1-1. Analog Control Connector (J1) Overview.....	50
4-1-2. External Voltage Control of Voltage Output.....	52
4-1-3. External Voltage Control of Current Output.....	54
4-1-4. External Resistance Control of Voltage Output.....	55
4-1-5. External Resistance Control of Current Output	57
4-1-6. External Control of Output.....	58
4-1-7. External control of Shutdown	60
4-1-8. External control of Alarm Clear	61
4-2. Remote Monitoring	62
4-2-1. External Voltage and Current Monitoring	62
4-2-2. External Operation and Status Monitoring.....	63
5. Communication Interface	66
5-1. USB Interface.....	66
5-1-1. USB Remote Interface	66
5-1-2. USB-CDC Remote Control Function Check.....	67
5-2. GPIB Interface	67
5-2-1. GPIB Remote Interface	67
5-2-2. GPIB Function Check.....	68
5-3. LAN Interface	71
5-3-1. Web Server Configuration.....	71
5-3-2. Web Server Remote Control Function Check	72
5-3-3. Socket Server Configuration	74
5-3-4. Socket Server Function Check.....	74
5-4. Serial Interface.....	78
5-4-1. UART Remote Interface.....	78
5-4-2. UART Function Check.....	79
5-5. Multidrop Interface	80
5-5-1. Multiple Unit Connection	80
5-5-1-1. Multi-Drop mode.....	80
5-5-1-2. Multi-Drop mode Function Check	83
6. FAQ	84

7. APPENDIX	85
7-1. PFR-100 Factory Default Settings	85
7-2. Error Messages & Messages	86
7-3. LED ASCII Table Character Set	87
7-4. Test Script Error Code	87
8. Specification list	88
8-1. Rating	88
8-1-1. Output	88
8-1-2. Constant Voltage Mode.....	88
8-1-3. Constant Current Mode.....	88
8-1-4. Protection Function	89
8-1-5. Analog Programming and Monitoring.....	89
8-1-6. Front Panel.....	90
8-1-7. Programming and Measurement (Control).....	90
8-1-8. Input Characteristics.....	91
8-1-9. Interface Capabilities.....	91
8-1-10. Environment Conditions	91
8-1-11. General Specifications	92
8-2. PFR-100 Dimensions.....	93



USING THE PRODUCT SAFELY

■ Preface

To use the product safely, read instruction manual to the end. Before using this product, understand how to correctly use it. If you read the manuals but you do not understand how to use it, ask us or your local dealer. After you read the manuals, save it so that you can read it anytime as required.

■ Pictorial indication

The manuals and product show the warning and caution items required to safely use the product. The following pictorial indication is provided.

Pictorial indication	
	Some part of this product or the manuals may show this pictorial indication. In this case, if the product is incorrectly used in that part, a serious danger may be brought about on the user's body or the product. To use the part with this pictorial indication, be sure to refer to the manuals.
	If you use the product, ignoring this indication, you may get killed or seriously injured. This indication shows that the warning item to avoid the danger is provided.
	If you incorrectly use the product, ignoring this indication, you may get slightly injured or the product may be damaged. This indication shows that the caution item to avoid the danger is provided.

Please be informed that we are not responsible for any damages to the user or to the third person, arising from malfunctions or other failures due to wrong use of the product or incorrect operation, except such responsibility for damages as required by law.

USING THE PRODUCT SAFELY



■ Do not remove the product's covers and panels

Never remove the product's covers and panels for any purpose. Otherwise, the user's electric shock or fire may be incurred.

■ Warning on using the product

Warning items given below are to avoid danger to user's body and life and avoid the damage or deterioration of the product. Use the product, observing the following warning and caution items.

■ Warning items on power supply

● Power supply voltage

The rated power supply voltages of the product are 100VAC. The rated power supply voltage for each product should be confirmed by reading the label attached on the back of the product or by the "rated" column shown in the instruction manual. The specification of power cord attached to the products is rated to 125VAC for all products which are designed to be used in the areas where commercial power supply voltage is not higher than 125VAC. Accordingly, you must change the power cord if you want to use the product at the power supply voltage higher than 125VAC. If you use the product without changing power cord to 250VAC rated one, electric shock or fire may be caused. When you used the product equipped with power supply voltage switching system, please refer to the corresponding chapter in the instruction manuals of each product.

● Power cord

(IMPORTANT) The attached power cord set can be used for this device only.

If the attached power cord is damaged, stop using the product and call us or your local dealer. If the power cord is used without the damage being removed, an electric shock or fire may be caused.

● Protective fuse

If an input protective fuse is blown, the product does not operate. For a product with external fuse holder, the fuse may be replaced. As for how to replace the fuse, refer to the corresponding chapter in the instruction manual. If no fuse replacement procedures are indicated, the user is not permitted to replace it. In such case, keep the case closed and consult us or your local dealer. If the fuse is incorrectly replaced, a fire may occur.

USING THE PRODUCT SAFELY

■ Warning item on Grounding

If the product has the GND terminal on the front or rear panel surface, be sure to ground the product to safely use it.

■ Warnings on Installation environment

● Operating temperature and humidity

Use the product within the operating temperature indicated in the “rating” temperature column. If the product is used with the vents of the product blocked or in high ambient temperatures, a fire may occur. Use the product within the operating humidity indicated in the “rating” humidity column. Watch out for condensation by a sharp humidity change such as transfer to a room with a different humidity. Also, do not operate the product with wet hands. Otherwise, an electric shock or fire may occur.

● Use in gas

Use in and around a place where an inflammable or explosive gas or steam is generated or stored may result in an explosion and fire. Do not operate the product in such an environment. Also, use in and around a place where a corrosive gas is generated or spreading causes a serious damage to the product. Do not operate the product in such an environment.

● Installation place

Do not insert metal and inflammable materials into the product from its vent and spill water on it. Otherwise, electric shock or fire may occur.

■ Do not let foreign matter in

Do not insert metal and inflammable materials into the product from its vent and spill water on it. Otherwise, electric shock or fire may occur.

■ Warning item on abnormality while in use

If smoke or fire is generated from the product while in use, stop using the product, turn off the switch, and remove the power cord plug from the outlet. After confirming that no other devices catch fire, ask us or your local dealer.

USING THE PRODUCT SAFELY

■ Input / Output terminals

Maximum input to terminal is specified to prevent the product from being damaged. Do not supply input, exceeding the specifications that are indicated in the "Rating" column in the instruction manual of the product. Also, do not supply power to the output terminals from the outside. Otherwise, a product failure is caused.

■ Calibration

Although the performance and specifications of the product are checked under strict quality control during shipment from the factory, they may be deviated more or less by deterioration of parts due to their aging or others.

It is recommended to periodically calibrate the product so that it is used with its performance and specifications stable. For consultation about the product calibration, ask us or your local dealer.

■ Daily Maintenance

When you clean off the dirt of the product covers, panels, and knobs, avoid solvents such as thinner and benzene. Otherwise, the paint may peel off or resin surface may be affected. To wipe off the covers, panels, and knobs, use a soft cloth with neutral detergent in it.

During cleaning, be careful that water, detergents, or other foreign matters do not get into the product.

If a liquid or metal gets into the product, an electric shock and fire are caused. During cleaning, remove the power cord plug from the outlet.

Use the product correctly and safely, observing the above warning and caution items. Because the instruction manual indicates caution items even in individual items, observe those caution items to correctly use the product.

If you have questions or comments about the manuals, ask us or E-Mail us.

1. GETTING STARTED

This chapter describes the power supply in a nutshell, including its main features and front / rear panel introduction. After going through the overview, please read the theory of operation to become familiar with the operating modes, protection modes and other safety considerations.

1-1. PFR-100 Series Overview

1-1-1. Series lineup

The PFR-100 series consists of 2 models, covering a number of different current, voltage and power capacities. The G model supports LAN and GPIB.

Model name	Voltage	Current	Rated Power	LAN	GP-IB
PFR-100L50				-	-
PFR-100L50G	0~50.00V	0~10.00A	100W	○	○
PFR100L50N				○	-
PFR-100M250				-	-
PFR-100M250G	0~250.0V	0~2.000A	100W	○	○
PFR-100M250N				○	-

1-1-2. Main Features

Performance	<ul style="list-style-type: none">• Variable voltage and current combinations with 5 times of coverage ratio of its range within the rated power.• Constant voltage / constant current with automatic crossover.• Active Power Factor correction.• Universal Input Voltage 80~265VAC, continuous operation.• Natural convection cooling(Fanless).
Features	<ul style="list-style-type: none">• Preset memory function (3sets).• Output ON/OFF delay function.• CV, CC priority start function. (prevents overshoot with output ON)• Adjustable voltage and current slew rates.• Bleeder circuit ON/OFF setting. (to prevent over-discharging of batteries)• OVP, OCP, AC FAIL and OHP protection.• Supports test scripts.• Web server monitoring and control. (The function is activated when connecting to LAN Interface)• Analog monitor output.• Remote sensing to compensate for voltage drop in load leads.• Built-in front panel and rear panel output terminal.
Interface	<ul style="list-style-type: none">• Built-in USB and RS-232C/RS-485 interface.• External analog control function.• GP-IB interface. (G model)• LAN interface.(N model,G mode)

1-1-3. Accessories

Standard	Part number	Description
Accessories	Power cord GTL-134	Depends on Regional and Type. Test leads for rear panel, 1.2m, 10A, 16AWG
PFR-100L	PFR-001	PFR-100L Accessory Kit Output terminal cover x 1 Output terminal x 1 Socket x 1 Protection cover x 2 Short Bar x 1
	GTL-104A	Test leads for PFR-100L, 1m, 10A
PFR-100M	PFR-002	PFR-100M Accessory Kit Output terminal cover x 1 Output terminal x 1 Socket x 1 Protection cover x 2 Short Wire x 1)
	GTL-105A	Test leads for PFR-100M, 1m, 3A
Option	Part number	Description
	GRA-431-J-100	Rack mount adapter (JIS) with AC 100V
	GRA-431-J-200	Rack mount adapter (JIS) with AC 200V
	GRA-431-E-100	Rack mount adapter (EIA) with AC 100V
	GRA-431-E-200	Rack mount adapter (EIA) with AC 200V
	GTL-258	GP-IB Cable for PFR Only
	GTL-259	RS-232C cable with DB9 connector, Terminator, Intermediate connector
	GTL-260	RS-485 cable with DB9 connector, Terminator, Intermediate connector
	GTL-261	RS-485 used master cable (gray plug) , Terminator, Intermediate connector
	GTL-262	slave cable (black plug)
	GTL-246	USB cable (USB 2.0 A - B)
Driver	Name	Description
	texio_cdc*.inf	USB driver Downloadable from web

1-2. Appearance

1-2-1. Front Panel



Function keys The Function keys along with the Output key will light up when a key is active.

Voltage Knob

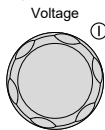

Used to set the voltage value or select a parameter number in the Function settings.

Current Knob

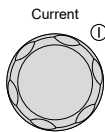

Used to set the current value or change the value of a Function parameter.

Function Key



Used to configure the various functions.

M1 Key

M1

(+Shift) Used to recall the M1 setup.
(+Shift and hold) Used to save the current setup to M1.

Test Key











Test

Used to run customized scripts for testing.

M2 Key

M2

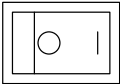
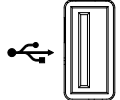
(+Shift) Used to recall the M2 setup.
(+Shift and hold) Used to save the current setup to M2.

Set Key	 Set	Used to set and confirm the output voltage and output current.
M3 Key	M3	(+Shift) Used to recall the M3 setup. (+Shift and hold) Used to save the current setup to M3.
Shift Key	 Shift	Used to enable the functions that are written in blue characters below certain buttons.
PWR_DSPL Key	 PWR_DSPL	(Long push) Displays the output power on the voltage meter or current meter. Press the Voltage knob for V/W, Press the Current knob for A/W.
Lock/Local Key	 Lock/Local	Used to lock all front panel buttons other than the Output Button or it switches to local mode.
Unlock Key	 Unlock	(Long push) Used to unlock the front panel buttons.
PROT Key	 PROT	Used to set and display OVP, OCP and UVL.
ALM_CLR Key	 ALM_CLR	(Long push) Used to release protection functions that have been activated.
Output Key	 Output	Used turn the output on/off.
Power switch		Used turn the power on/off.
USB A port		USB A port for data transfer, loading test scripts etc.
Output terminal PFR-100M		250V/2A/100W
PFR-100L		50V/10A/100W
Display indicators	VSR CV RMT ALM DLY CC	Lights up when CV Slew Rate Priority is enabled. Lights in green during constant voltage mode. Lights in green during remote control. Lights in red when a protection function has been activated. The Output On/Off Delay indicator LED. Lights in green during constant current mode.

ISR	Lights up when CC Slew Rate Priority is enabled.
ERR	Lights in red when an error has occurred.
LAN	Lights up when the LAN remote connection is established.
M1	Lights in green when the memory value are being recalled or saved.
M2	Lights in green when the memory value are being recalled or saved.
M3	Lights in green when the memory value are being recalled or saved.
V or W	Display Voltage or Watt unit.
RUN	Lights up when a Test Script has been activated.
A or W	Display Current or Watt unit.
Upper numeric	8888 Displays the voltage or the parameter number of a Function parameter.
Lower numeric	8888 Displays the current or the value of a Function parameter.

1-2-2. Rear Panel

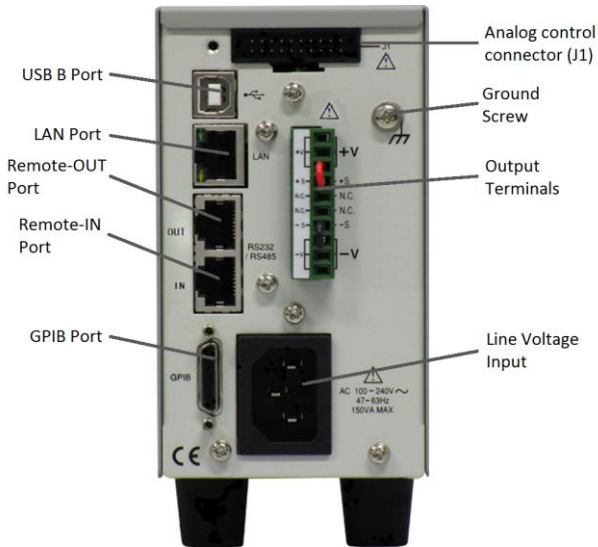

Analog Control Connector (J1)



Standard 26 pin MIL connector (OMRON XG4C plug).

The analog control connector is used to monitor current and voltage output, machine status (OVP, OCP, OHP etc.), and for analog control of the current and voltage output. Use an OMRON XG5M socket as the mating socket.

Output Terminals It uses a 10 pin connector and a plug for the output and sense terminal connectors. The plug is MC420-38110Z made by DECA SwitchLab.

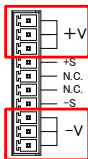

Positive (+) and negative (-) output terminals.



Chassis ground

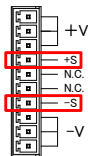

Sense (-) and Sense (+) terminals.

USB B port

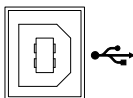

The USB B port is used for remote control.

Remote-OUT port

RJ-45 connector that is used to daisy chain power supplies with the Remote-IN port to form a communication bus.

Remote-IN port

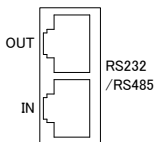

Two different types of cables can be used for RS232 or RS485-based remote control.

GTL-259: RS232 cable with DB9 connector kit.

GTL-260: RS485 cable with DB9 connector kit.

LAN (Ethernet) port

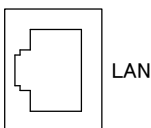

The ethernet port is used for remote control and digital monitoring from a PC. (G model, N model)

GPIB port

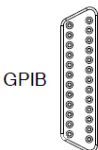

GPIB connector for units equipped with IEEE programming option. . (G model only)

Line Voltage Input

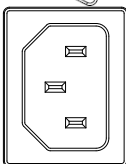

Voltage Input: 100~240 VAC (automatically switchable)
Line frequency: 50Hz / 60Hz

1-3. Theory of Operation

The theory of operation chapter describes the basic principles of operation, protection modes and important considerations that must be taken into account before use.

1-3-1. Operating Area Description

Background

The PFR-100 power supplies are regulated DC power supplies with a high voltage and current output. These operate in CC or CV mode within a wide operating range limited only by the output power.

The operating area of each power supply is determined by the rated output power as well as the voltage and current rating. Below is a comparison of the operating areas of each power supply.

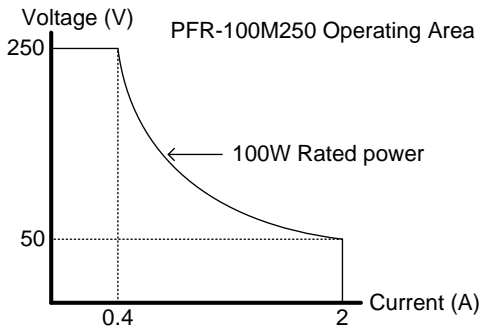
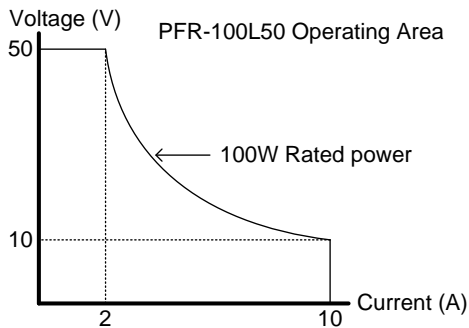

When the power supply is configured so that the total output (current x voltage output) is less than the rated power output, the power supply functions as a typical constant current, constant voltage power supply.

If however, the power supply is configured such that the total output (current x voltage output) exceeds the rated power output, the effective output is actually limited to the power limit of the unit. In this case the output current and voltage then depend purely on the load value.

1-3-2. CC and CV Mode

CC and CV mode
Description

When the power supply is operating in constant current mode (CC) a constant current will be supplied to the load. When in constant current mode the voltage output can vary, whilst the current remains constant. When the load resistance increases to the point where the current limit (I_{SET}) can no longer be sustained the power supply switches to CV mode. The point where the power supply switches modes is the crossover point.

When the power supply is operating in CV mode, a constant voltage will be supplied to the load, whilst the current will vary as the load varies. At the point that the load resistance is too low to maintain a constant voltage, the power supply will switch to CC mode and maintain the set current limit.

The conditions that determine whether the power supply operates in CC or CV mode depends on the set current (I_{SET}), the set voltage (V_{SET}), the load resistance (R_L) and the critical resistance (R_C). The critical resistance is determined by V_{SET}/I_{SET} . The power supply will operate in CV mode when the load resistance is greater than the critical resistance. This means that the voltage output will be equal to the V_{SET} voltage but the current will be less than I_{SET} . If the load resistance is reduced to the point that the current output reaches the I_{SET} level, the power supply switches to CC mode.

Conversely the power supply will operate in CC mode when the load resistance is less than the critical resistance. In CC mode the current output is equal to I_{SET} and the voltage output is less than V_{SET} .

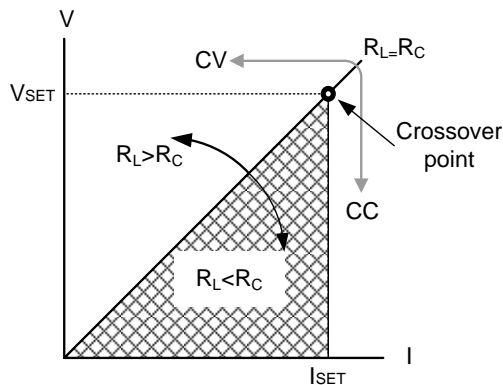

1-3-3. Slew Rate

Theory

The PFR-100 has selectable slew rates for CC and CV mode. This gives the PFR-100 power supply the ability to limit the current/voltage draw of the power supply. Slew rate settings are divided into High Speed Priority and Slew Rate Priority. High Speed Priority mode disables slew rate settings for CC or CV mode. Slew Rate Priority mode allows for user adjustable slew rates for CC or CV mode. The rising and falling slew rate can be set independently.

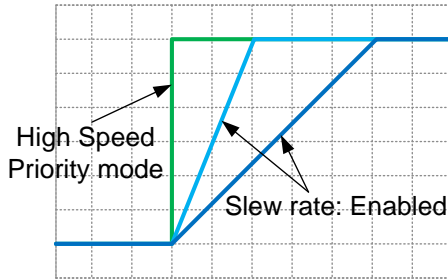

1-3-4. Bleeder Control

Background

The PFR-100 DC power supplies employ the bleeder circuit in parallel with the output terminals.

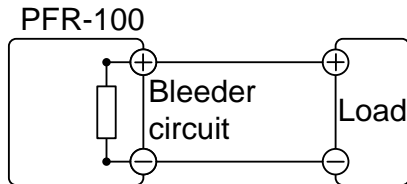

The bleeder circuit is designed to dissipate the power from the power supply filter capacitors when power is turned off and the load is disconnected. Without the bleeder circuit, power may remain charged on the filter capacitors for some time and be potentially hazardous.

In addition, the bleeder circuit also allow for smoother voltage regulation of the power supply as the bleeder circuit acts as a minimum voltage load.

The bleeder circuit can be turned on or off using the configuration settings

A setting of AUTO to turn on the bleeder when output is on, the output will turn off the bleeder when off.



Note

By default the bleeder circuit is on. For battery charging applications, be sure to turn the bleeder circuit off as the bleed resistor can discharge the connected battery when the unit is off.

1-3-5. Sink Current Table

Background Sink current (reference value) from an external voltage source according to the bleeder circuit setting.

PFR-100M250	Vout	Bleeder ON	Bleeder OFF
	Sink Current		
	(V)	(A)	(mA)
	25	0.135	0.001
	50	0.119	0.007
	75	0.103	0.014
	100	0.087	0.022
	125	0.071	0.032
	150	0.055	0.034
	175	0.039	0.043
	200	0.034	0.051
	225	0.031	0.067
	250	0.028	0.086

PFR-100L50	Vout	Bleeder ON	Bleeder OFF
	Sink Current		
	(V)	(A)	(mA)
	5	0.746	0.006
	10	0.658	0.009
	15	0.570	0.013
	20	0.482	0.017
	25	0.375	0.026
	30	0.310	0.038
	35	0.257	0.038
	40	0.236	0.048
	45	0.218	0.074
	50	0.200	0.200

1-3-6. Alarms

The PFR-100 power supplies have a number of protection features. When one of the protection alarms are set, the ALM icon on the display will be lit. For details on how to set the protection modes, please see page 23.

OVP	Over voltage protection (OVP) prevents a high voltage from damaging the load. This alarm can be set by the user.
OCP	Over current protection prevents high current from damaging the load. This alarm can be set by the user.
OPP	Over power protection prevents abnormally use from damaging the PFR-100. When the output powers is over 103W, the alarm LED flashes. After a little time, OPP will be triggered and turn off output.
UVL	Under voltage limit. This function sets a minimum voltage setting level for the output. It can be set by the user.
OHP	Over temperature protection protects the instrument from overheating.(Typ. 90°C)
AC FAIL	AC Fail. This alarm function is activated when a low AC input is detected. (Typ.80V)
SENSE ALARM1	This alarm function is activated when real output voltage is larger than sense output voltage. $V_{o_real} > V_{o_sense} + 1.5V$ for PFR-100L50 $V_{o_real} > V_{o_sense} + 2.5V$ for PFR-100M250
SENSE ALARM2	This alarm function is activated when sense output voltage is larger than real output voltage. $V_{o_sense} > V_{o_real} + 1V$
Shutdown	Force Shutdown is not activated as a result of the PFR-100 series detecting an error. It is a function that is used to turn the output off through the application of a signal from the rear-panel analog control connector when an abnormal condition occurs.
Alarm output	Alarms are output via the analog control connector. The alarm output is an isolated open-collector photo coupler output.

1-3-7. Considerations

The following situations should be taken into consideration when using the power supply.

Inrush current	When the power supply switch is first turned on, an inrush current is generated. Ensure there is enough power available for the power supply when first turned on, especially if a number of units are turned on at the same time.
 Caution	Cycling the power on and off quickly can cause the inrush current limiting circuit to fail as well as reduce the working life of the input fuse and power switch.
Pulsed or Peaked loads	When the load has current peaks or is pulsed, it is possible for the maximum current to exceed the mean current

value. The PFR-100 power supply ammeter only indicates mean current values, which means for pulsed current loads, the actual current can exceed the indicated value. For pulsed loads, the current limit must be increased, or a power supply with a greater capacity must be chosen. As shown below, a pulsed load may exceed the current limit and the indicated current on the power supply ammeter.

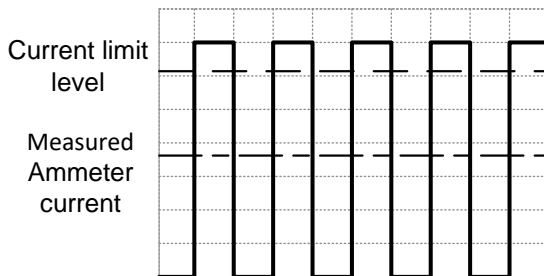

Note

The LED message showed on the display will vary depending on the F-17 setting.

Reverse Current:
Regenerative load

When the power supply is connected to a regenerative load such as a transformer or inverter, reverse current will feed back to the power supply. The PFR-100 power supply cannot absorb reverse current. For loads that create reverse current, connect a resistor in parallel to the power supply to bypass the reverse current.

To calculate the minimum resistance for the resistor, R_D , first determine the maximum reverse current, I_R , and determine what the output voltage, E_O , will be.

$$R_D(\Omega) \leq E_O(V) \div I_R(A)$$

PFR-100

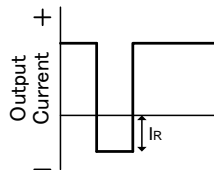
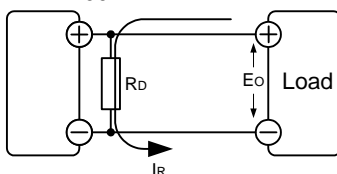

Note

The current output will decrease by the amount of current absorbed by the resistor.

Ensure the resistor used can withstand the power capacity of the power supply/load.

Reverse Current: Accumulative energy	When the power supply is connected to a load such as a battery, reverse current may flow back to the power supply. To prevent damage to the power supply, use a reverse-current-protection diode in series between the power supply and load.
--	---

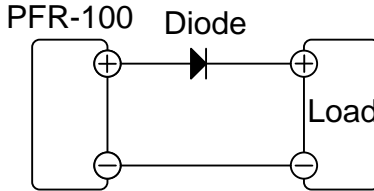

! CAUTION

Ensure the reverse withstand voltage of the diode is able to withstand 2 times the rated output voltage of the power supply and the forward current capacity can withstand 3 to 10 times the rated output current of the power supply. Ensure the diode is able to withstand the heat generated in the following scenarios.

When the diode is used to limit reverse voltage, remote sensing cannot be used.

When connect to the charged load, should be careful to avoid electric shocks and sparks.

1-3-8. Grounding

The output terminals of the PFR-100 power supplies are isolated with respect to the protective grounding terminal. The insulation capacity of the load, the load cables and other connected devices must be taken into consideration when connected to the protective ground or when floating.

Floating	As the output terminals are floating, the load and all load cables must have an insulation capacity that is greater than the isolation voltage of the power supply.
----------	---

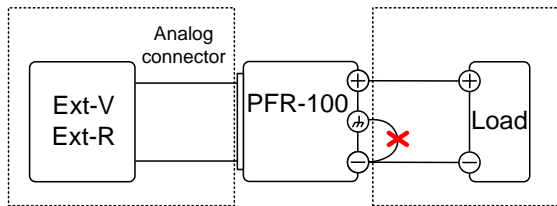

(---) Insulation capacity \geq Isolation voltage of Power supply



WARNING

If the insulation capacity of the load and load cables is not greater than the isolation voltage of the power supply, electric shock may occur.

When the unit is analog controlled with external voltage control and external resistance control, the control signal should be floated without grounding (floating). If it is grounded, the output is shorted and causes an accident.

Grounded output terminal

If the positive or negative terminal is connected to the protective ground terminal, the insulation capacity needed for the load and load cables is greatly reduced. The insulation capacity only needs to be greater than the maximum output voltage of the power supply with respect to ground.

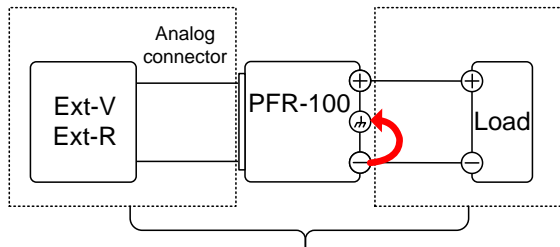

() Insulation capacity \geq Voltage of power supply with respect to ground



CAUTION

If using external voltage control, do not ground the external voltage terminal as this will create a short circuit.

2. OPERATION

2-1. Set Up

2-1-1. Power up

Background

Make sure that the power source is shut off.
Use the AC power cable supplied with the product.

Steps

1. Connect the power cord to the rear panel socket.

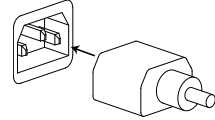

2. Press the POWER switch on. If used for the first time, the default settings will appear on the display, otherwise the state right before the power was last turned OFF. For default configuration settings, see page 85.

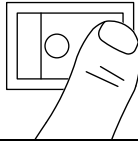

Caution

Do not turn the power on and off quickly. Please wait for the display to fully turn off.

2-1-2. Wire Gauge Considerations

Background

Before connecting the output terminals to a load, the wire gauge of the cables should be considered.
It is essential that the current capacity of the load cables is adequate. The rating of the cables must equal or exceed the maximum current rated output of the instrument.

Recommended wire gauge

Wire Gauge (AWG)	Nominal Cross Section (mm ²)	Maximum Current (A)
20	0.5	9
18	1	13
16	1.5	18
14	2.5	24
12	4	34
10	6	45

The maximum temperature rise can only be 60 degrees above the ambient temperature. The ambient temperature must be less than 30 degrees.

2-1-3. The Rear Panel Output Terminal

Background The PFR-100 series use a 10 pin socket for the output voltage and sense connections. The corresponding plugs (DECA SwitchLab MC420-38110Z) should be used to connect the terminals to the appropriate cable. Before connecting the output terminals to the load, first consider whether voltage sense will be used, the gauge of the cable wiring and the withstand voltage of the cables and load.

 **WARNING** Dangerous voltages. Ensure that the power to the instrument is disabled before handling the power supply output terminals. Failing to do so may lead to electric shock.

Output Connector Overview When using the rear panel output terminal, make sure the wires that are used follow the following guidelines:

- Wire gauge: AWG 28 to AWG 16
- Strip length: 6.5mm // 0.26in.
- Current ratings: 10A
- Insulation withstand voltage: AC 2000V min
- Insulation resistance: >2000MΩ DC500V
- Operation Temperature: -40°C to +105°C

Output Connector Pinout

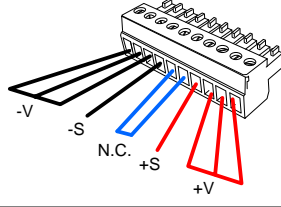

- V: -V terminals (x3)
- S: -Sense terminal
- NC: Not connected
- +S: +Sense terminal
- +V: +V terminals (x3)

Wiring the Connector Plug

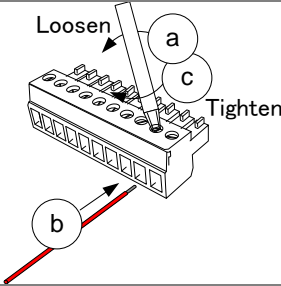

- a. Unscrew the appropriate terminal anticlockwise to release the receptacle.
- b. Insert a wire that has had at least ~6.5mm stripped from the insulation.
- c. Tighten the receptacle by screwing clockwise.

Steps

1. Turn the power switch off.
2. Remove the rear panel output terminal cover.
3. Choose a suitable wire gauge for the load cables.
4. Use flathead screwdriver to connect the load cable and output terminal.

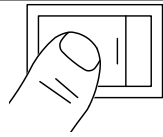

- Connect the positive load cable to the positive output terminal and the negative cable to the negative output terminal.



WARNING

Please note the wire gauge used and the capacity of the plug/socket. It may be necessary to wire the load to a number of terminals to offset the capacity over a number of terminals.

- When not using remote sensing, be sure to connect the sensing terminal to each output terminal. For remote sensing, see the remote sense chapter. (see page 31)

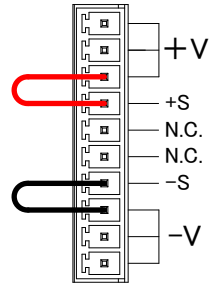

- If necessary, connect the chassis ground screw to either the -V or +V pin.

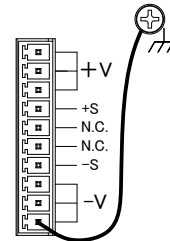

- Reattach the output terminal cover.

2-1-4. The Front Panel Output Terminal

Steps

- Turn the power switch off.

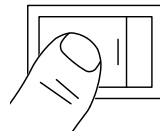



2. Connect the test lead includes in the accessory parts to front panel output terminal. (GTL-104A is used for PFR-100L, GTL-105A is used for PFR-100M)
3. Fix the load cables firmly to eliminate loose connections from the front output terminals and load cables. For safety, Never output power through both the front and rear output terminals.
4. If necessary, connect the chassis ground terminal to either the -V or +V terminal.



PFR-100L50
(Short Bar)



PFR-100M250
(Short wire)

5. If using the front output terminal, it is necessary to connect the remote sensing cable on the back and the rear output connector.

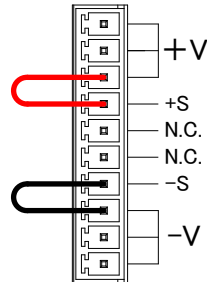

2-1-5. Using the Output Terminal Cover

Steps	<ol style="list-style-type: none">1. Screw the bottom cover onto the rear panel using the two M3 screws.2. Slide the top cover over the bottom cover.3. Finally, secure the top cover with the screw in the center of the top cover.
Removal	Reverse the procedure to remove the terminal covers.

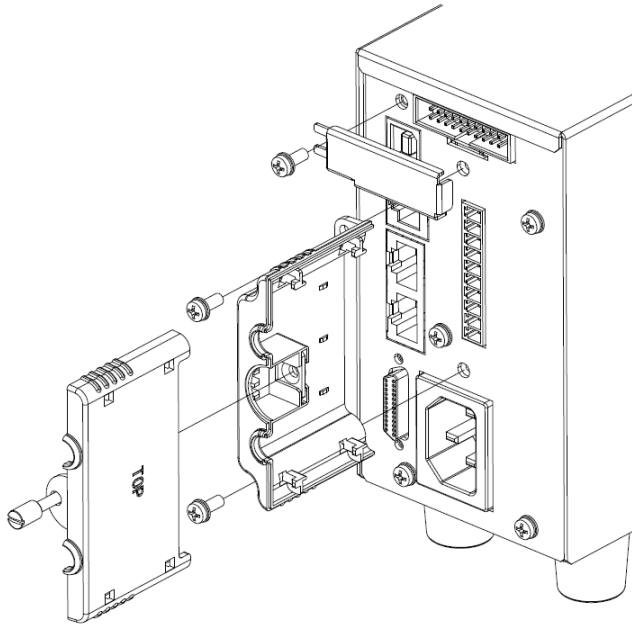

2-1-6. Using the Rack Mount Kit

Background

The PFR-100 series has an optional Rack Mount Kit: [JIS] GRA-431-J, [EIA] GRA-431-E) that can be used to hold 5 units into rack.

Rack mount diagram



2-1-7. How to Use the Instrument

Background

The PFR-100 power supplies use a novel method of configuring parameter values only using the voltage or current knobs. The knobs are used to quickly edit parameter values at different unit steps at a time. When the user manual says to set a value or parameter, use the steps below.

Example

- Use the voltage knob to set a voltage of 10.05 volts.
1. Repeatedly press the voltage knob until the last digit is highlighted. This will allow the voltage to be edited in 0.01 volt steps.
 2. Turn the voltage knob till 0.05 volts is shown.

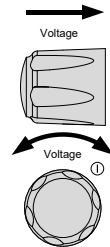
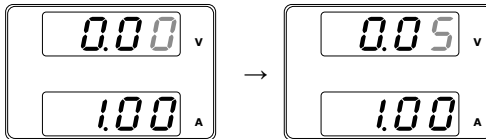

3. Repeatedly press the voltage knob until the first digit is highlighted. This will allow the voltage to be edited in 1 volt steps.
4. Turn the voltage knob until 10.05 is shown.

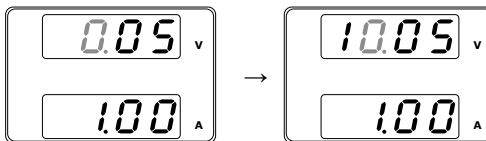

Note

Notice the Set key becomes illuminated when setting the current or voltage.
If the voltage or current knobs are unresponsive, press the Set key first.

2-1-8. Reset to Factory Default Settings

Background

The F-88 configuration setting allows the PFR-100 to be reset back to the factory default settings. See page 85 for the default factory settings.

Steps

1. Press the Function key. The Function key will light up.
2. The display should show F-01 on the top and the configuration setting for F-01 on the bottom.
3. Rotate the voltage knob to change the F setting to F-88 (Factory Set Value)

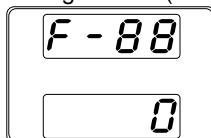

Function

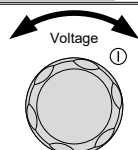
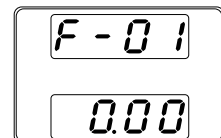

- Use the current knob to set the F-88 setting to 1 (Return to factory settings).

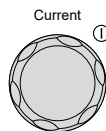
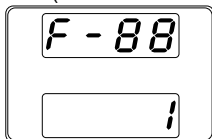

- Press the Voltage knob to confirm. ConF will be displayed when successful.

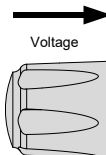
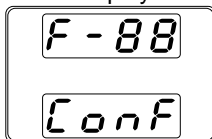

- Press the Function key again to exit. The function key light will turn off.

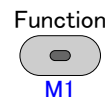

Note

Data of the test script is not cleared by the initialization by F-88. Please be cleared in the deletion of the test data.
 Data of the preset memory (M1, M2, M3) is not cleared by the initialization by F-88.
 The Interface Select (F-29) is not initialized by F-88.

2-1-9. View System Version and Build Date

Background

The F-89 configuration setting allows you to view the PFR-100 version number, build date, keyboard version, and analog-control version.

Steps

- Press the Function key. The Function key will light up.

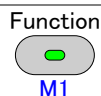

- The display should show F-01 on the top and the configuration setting for F-01 on the bottom.



- Rotate the voltage knob to change the F setting to F-89 (Show Version).

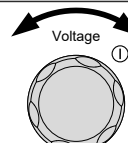

- Rotate the current knob to view the version and build date for the various items

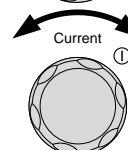

- F-89 0-XX : Main Program Version
- 1-XX : Main Program Version
- 2-XX : Main Program Build On-Year.
- 3-XX : Main Program Build On-Year.
- 4-XX : Main Program Build On-Month.
- 5-XX : Main Program Build On-Day.
- 6-XX : Keyboard CPLD version.
- 7-XX : Keyboard CPLD version.
- 8-XX : Analog CPLD version
- 9-XX : Analog CPLD version

5. Press the Function key again to exit. The function key light will turn off.

Function



M1

Example Main Program Version : Ver 01.00 : 2017/06-01
 0-01: Main Program Version
 1-00: Main Program Version
 2-20: Main Program Build On-Year
 3-17: Main Program Build On-Year
 4-06: Main Program Build On-Month
 5-01: Main Program Build On-Day

Example Keyboard CPLD version: 0x3305
 6-33: Keyboard CPLD version
 7-05: Keyboard CPLD version

Example Analog CPLD version: 0x0408
 8-04: Analog CPLD Version.
 9-08: Analog CPLD Version.

2-2. Basic Operation

This section describes the basic operations required to operate the power supply. Before operating the power supply, please see the Getting Started chapter.

2-2-1. Setting OVP/OCP/UVL Levels

Background

The OVP level and OCP level has a selectable range that is based on the output voltage and output current, respectively. The OVP and OCP level is set to the highest level by default. The actual selectable OVP and OCP range depends on the PFR-100 model.

When one of the protection measures are on, ALM indicator is lit red on the front panel and the type of alarm is also shown on the display. The ALM_CLR button can be used to clear any protection functions that have been tripped. By default, the output will turn off when the OVP or OCP protection levels are tripped.

The UVL will prevent you from setting a voltage that is less than the UVL setting. The UVL setting range is from 0% ~ 105% of the rated output voltage.

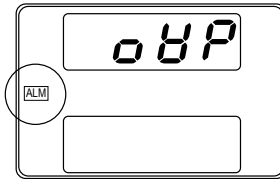

Before setting the protection settings:

- Ensure the load is not connected.
- Ensure the output is set to off.

Range

Model	Setting Range		
	OCP(A)	OVP(V)	UVL(V)
PFR-100L50	1~11	5~55	0~52.5
PFR-100M250	0.2~2.2	5~275	0~262.5



Note

You can use the Function settings (F-13 and F-14) to apply limits to the voltage and current settings, respectively. You can set limitations so that the values do not exceed the set OVP and the set OCP level, and so that the values are not lower than the set UVL trip point.

By using this feature, you can avoid turning the output off by mistakenly setting the voltage or current to a value that exceeds the set OVP or OCP level or to a value that is lower than the set UVL trip point.

If you have selected to limit the voltage setting (F-14), you will no longer be able to set the output voltage to a value that is above about 95% of the OVP trip point or to a value that is lower than the UVL trip point.

If you have selected to limit the current setting (F-13), you will no longer be able to set the output current to a value that is above

about 95% of the OCP trip point.

Steps

1. Press the PROT key. The PROT key lights up.



OVP Setting

2. The OVP function will be displayed on the voltage display and the setting will be displayed on the current display.

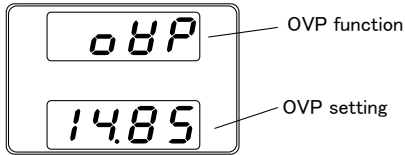

OVP Level

3. Use the Current knob to set the OVP level.

Range 5V~110% of rated output voltage

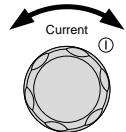

OCP Setting

4. Next turning the Voltage knob to the right, the OCP function will be displayed on the voltage display and the setting will be displayed on the current display.

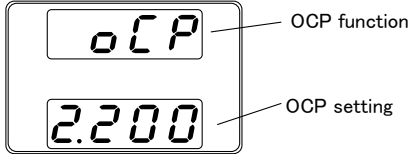
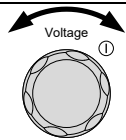

OCP Level

5. Use the Current knob to set the OVP level.
Range 10%~110% of rated output current

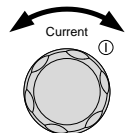

6. Press PROT again to exit. The PROT key light will turn off.

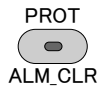

UVL Setting

1. Press the Function key and set F-14 (Voltage Setting Limit) to 1.

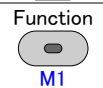

2. Press the PROT key. The PROT key lights up.



- Turning the Voltage knob to the right until the UVL function will be displayed on the voltage display and the setting will be displayed on the current display.

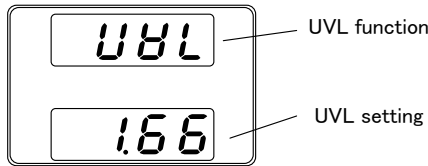
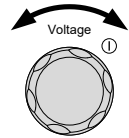

UVL Level

- Use the Current knob to set the UVL level.
Range 5V~105% of rated output voltage

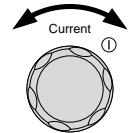

- Press PROT again to exit. The PROT key light will turn off.

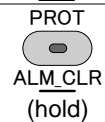

Clear
OVP/OCP/UVL

The OVP, OCP or UVL can be cleared by holding the PROT key for 3 seconds.

2-2-2. Set to CV Mode

When setting the power supply to constant voltage mode, a current limit must also be set to determine the crossover point. When the current exceeds the crossover point, the mode switches to CC mode. For details about CV operation, see page 8. CC and CV mode have two selectable slew rates: High Speed Priority and Slew Rate Priority. High Speed Priority will use the fastest slew rate for the instrument while Slew Rate Priority will use a user-configured slew rate.

Background

Before setting the power supply to CV mode, ensure.

- The output is off.
- The load is connected

Steps

- Press the Function key. The Function key will light up.



The display should show F-01 on the top and the configuration setting for F-01 on the bottom.



2. Rotate the voltage knob to change the F setting to F-03 (V-I Mode Slew Rate Select).

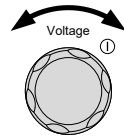

3. Use the current knob to set the F-03 setting. Set F-03 to 0 (CV High Speed Priority) or 2 (CV Slew Rate Priority).

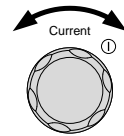

F-03 0 = CV High Speed Priority
 2 = CV Slew Rate Priority

4. Press the Voltage knob to save the configuration setting. Conf will be displayed when successful.

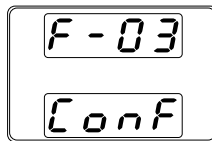
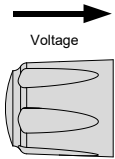

5. If CV Slew Rate Priority was chosen as the operating mode, repeat steps 3~5 to set F-04 (Rising Voltage Slew Rate) and the F-05 (Falling Voltage Slew Rate) and save.
 F-04 / F-05 0.1V/s~100.0V/s (PFR-100L50)
 0.1V/s~500.0V/s (PFR-100M250)

6. Press the Function key again to exit the configuration settings. The function key light will turn off.



7. Use the Current knob to set the current limit (crossover point).

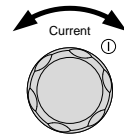

8. Use the Voltage knob to set the voltage.

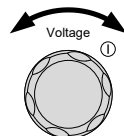

Notice the Set key becomes illuminated when setting the current or voltage. If the voltage or current knobs are unresponsive, press the Set key first.

9. Press the Output key. The Output key becomes illuminated.

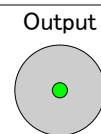

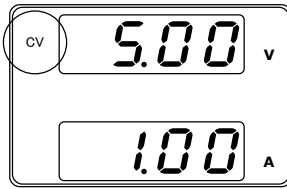

CV will become illuminated



Note

Only the voltage level can be altered when the output is on. The current level can only be changed by pressing the Set key.

For more information on the Normal Function Settings, see page 40.

2-2-3. Set to CC Mode

When setting the power supply to constant current mode, a voltage limit must also be set to determine the crossover point. When the voltage exceeds the crossover point, the mode switches to CV mode. For details about CC operation, see page 8. CC and CV mode have two selectable slew rates: High Speed Priority and Slew Rate Priority. High Speed Priority will use the fastest slew rate for the instrument while Slew Rate Priority will use a user-configured slew rate.

Background	Before setting the power supply to CC mode, ensure <ul style="list-style-type: none"> • The output is off. • The load is connected
------------	--

Steps	1. Press the Function key. The Function key will light up.	Function 
	The display should show F-01 on the top and the configuration setting for F-01 on the bottom.	



2. Rotate the voltage knob to change the F setting to F-03 (V-I Mode Slew Rate Select).
3. Use the current knob to set the F-03 setting. Set F-03 to 1 (CC High Speed Priority) or 3 (CC Slew Rate Priority) and save.

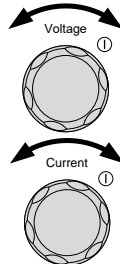

F-03 1 = CC High Speed Priority
 3 = CC Slew Rate Priority

- Press the Voltage knob to save the configuration setting. ConF will be displayed when successful.

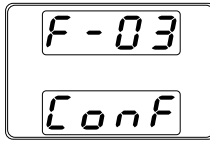
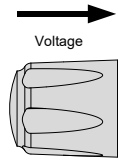

- If CC Slew Rate Priority was chosen as the operating mode, set F-06 (Rising Current Slew Rate) and F-07 (Falling Current Slew Rate) and save.
F-06 / F-07 0.01A/s~20.00A/s (PFR-100L50)
0.001A/s~4.000A/s (PFR-100M250)

- Press the Function key again to exit the configuration settings. The function key light will turn off.
- Use the Voltage knob to set the voltage limit (crossover point).

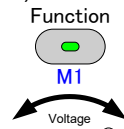

- Use the Current knob to set the current.

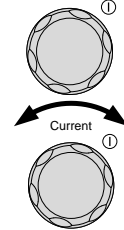

Note

Notice the Set key becomes illuminated when setting the current or voltage. If the voltage or current knobs are unresponsive, press the Set key first.

- Press the Output key. The Output key becomes illuminated.

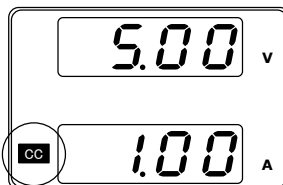
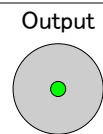

CC will become illuminated

Note

Only the current level can be altered when the output is on. The voltage level can only be changed by pressing the Set key.

For more information on the Normal Function Settings, see page 40.

2-2-4. Display Modes

The PFR-100 power supplies allow you to view the output in three different modes: voltage and current, voltage and power or current and power.

Steps

1. Hold the PWR_DSPL (SHIFT) key for 3 seconds. The display change to voltage and power (V/W).

Shift



PWR_DSPL



Note

If the PWR_DSPL key is lit, press the key again to turn it off, then perform step 1 again.

2. To switch between displaying A/W and V/W, simply press the corresponding Voltage or Current knob.

For example: when in A/W mode, press the voltage knob to display V/W. Conversely when in V/W mode, press the current knob to display A/W.

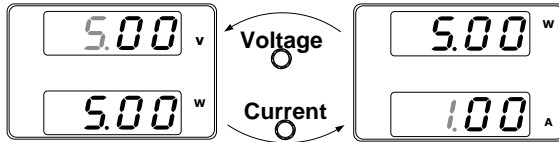

- When V/W is displayed, the voltage knob can still be used to change the voltage level.
- When A/W is displayed, the current knob can still be used to change the current level.

Exit

Hold the PWR_DSPL key again for 3 seconds return to normal display mode.

Shift



PWR_DSPL

2-2-5. Panel Lock

The panel lock feature prevents settings from being changed accidentally. When activated, the Lock/Local key will become illuminated and all keys and knobs except the Lock/Local key and Output key (if active) will be disabled. The operation of the Output key can be set with F-19. The initial value is valid only for the OFF operation.

If the instrument is remotely controlled via the interface such as RS-232C/USB, the panel lock is automatically enabled.

Activate the panel lock

Press the Lock/Local key to activate the panel lock. The key will become illuminated.

Lock/Local



Unlock

Disable the panel lock

Hold the Lock/Local key for 3 seconds to disable the panel lock. The Lock/Local light will turn off.

Lock/Local



Unlock

2-2-6. Preset Memory

The PFR-100 has three preset memories (M1, M2, M3) and can save and recall the set current, set voltage, OVP, OCP and UVL settings.

Save Setup

1. Make this unit the setting you want to save.
2. Press the SHIFT key. The shift key will light blue.
3. Hold the desired memory key for >3 seconds (M1, M2, M3).
When the setup is saved the unit will beep, the setup will be saved and the memory number will be shown on the display.

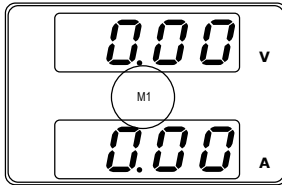
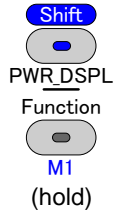

Save to M1

4. Press the SHIFT key. The SHIFT light turns off.

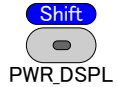

Recall Setup

1. Press the SHIFT key. The shift key will light blue.
2. Press the desired memory key to recall the desired setup (M1, M2, M3).
3. When the setup is recalled the setup will be loaded and the memory number will be shown on the display.

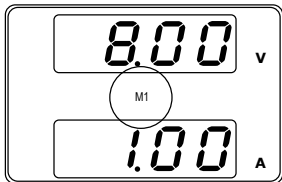
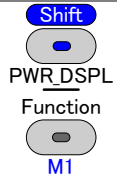

Recalled M1



Note

The F-15 function setting will determine whether the saved contents of the recalled memory setting are displayed or not.

2-2-7. Remote Sensing

Remote sense is used to compensate for the voltage drop seen across load cables due to the resistance inherent in the load cables. The remote sense terminals are connected to the load terminals to determine the voltage drop across the load cables.

Remote sense can compensate up to 1 volts for PFR-100L50 and PFR-100M250 (compensation voltage). Load cables should be chosen with a voltage drop less than the compensation voltage.



WARNING

Ensure the output is off before handling the remote sense connector.

Use sense cables with a voltage rating exceeding the isolation voltage of the power supply.

Never connect sensing cables when the output is on.

Electric shock or damage to the power supply could result.

The remote sensing, please wire it definitely.

PFR-100 cannot control the output when you turn on

OUTPUT in the state that remote sensing was against and may damage load and PFR-100.

Output terminal Connector Overview

When using the remote sensing, make sure the wires that are used follow the following guidelines:

Wire gauge:

AWG 28 to AWG 16

Strip length:

6.5mm // 0.26 in.

+S: +Sense terminal

-S: -Sense terminal

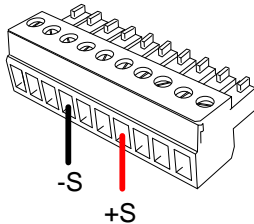

Note

Be sure to remove the Sense joining plates so the units are not using local sensing.

Single Load

1. Connect the Sense+ terminal to the positive potential of the load. Connect the Sense- terminal to the negative potential of the load.

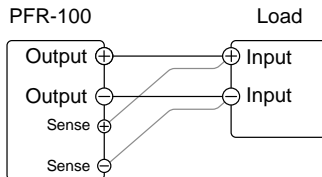

2. Operate the instrument as normal. See the Operation chapter (page 15) for details.

Wire Shielding and Load line impedance

To help to minimize the oscillation due to the inductance and capacitance of the load cables, use an electrolytic capacitor in parallel with the load terminals. To minimize the effect of load line impedance use twisted wire pairing.

Shield the sense wires and connect the shield to the chassis ground.

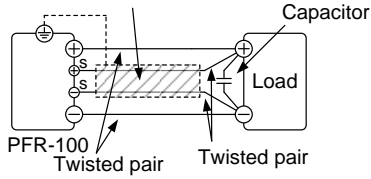

Note

The remote sensing, please wire it definitely.

2-3. Test Script

This section describes how to use the Test function to run, load and save test scripts for automated testing. The Test function is useful if you want to perform a number of tests automatically. The PFR-100 test function can store one test script at a time in memory.

The test data can be read from a USB drive device that you created in CSV format. Please use it in the state that you deleted files other than test.

2-3-1. Test Script File Format

Background	The test files are saved in *.csv file format. Each file is saved as tXXX.csv, where XXX is the save file number 001~010.
------------	--

2-3-2. Test Script Settings

Test Run	Runs the chosen test script from the internal memory. A script must first be loaded into the internal memory before it can be run. Only one script can be loaded into the internal memory at the same time. See the test function Test Load, below. The script will run by "OUTPUT" key. T-01 "n" or "y"
Test Load (USB→PFR)	Loads a test script from the USB drive to the designated save slot in memory. A script must first be loaded into internal memory before it can be run. T-02 1~10
Test Export (PFR→USB)	Exports the script from internal memory to the USB drive. T-03 1~10
Test Remove	Deletes the test script from the PFR-100 internal memory. T-04 "n" or "y"
Available Test Memory	Shows the amount of space left in memory for tests. T-05 Displays the available memory in bytes.

2-3-3. Setting the Test Script

- | | |
|-------|---|
| Steps | The test script settings (T-01~T-05) are set with the Test key. |
|-------|---|
1. Press the Test key. The Test key will light up. 
 2. The display will show T-01 on the top and the memory indication on the bottom. The bottom of the screen will indicate whether the memory has a script loaded, "y" (yes) or "n" (no).

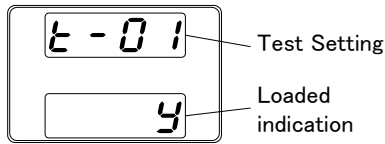

3. Rotate the Voltage knob to change the T setting (Test setting).

Test Run	T-01
Test Load	T-02
Test Export	T-03
Test Remove	T-04
Available Test Memory	T-05

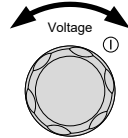

4. Rotate the Current knob to choose a memory number.
memory number 1~10

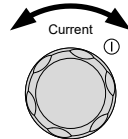

5. Press the Voltage knob to complete the setting.

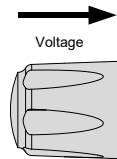

Exit Test Script Press the Test key again to exit the Test settings. The Test key light will turn off.

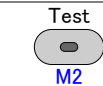

2-3-4. Load Test Script from USB drive

Overview Before a test script can be run, it must first be loaded into the internal memory.

- Before loading a test script into memory:
 - Ensure the script file is placed in the root directory.

 Note

Since only one test script can be saved in the unit, the previously saved script will be overwritten by the saved script later.

Steps

1. Insert a USB flash drive into the front panel USB-A slot. Ensure the flash drive contains a test script in the root directory.
2. MS (Mass Storage) will be displayed on the screen after a few seconds if the USB drive is recognized.

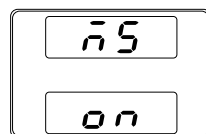
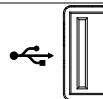



Note

If the USB drive is not recognized, check to see that the function settings for F-20 = 1 (page 45). If not, reinsert the USB flash drive. If you want to use the USB flash driver, F29 can't be set to 3

3. Configure T-02 (Test Load) to load test script Page 33 to internal memory.
T-02 Memory number 1~10 (t001~t010)

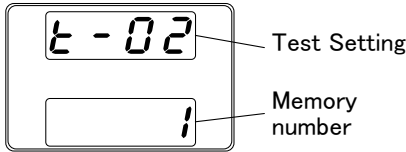

4. When press the Voltage knob, the test script is stored in the memory of the unit and the test mode is available.

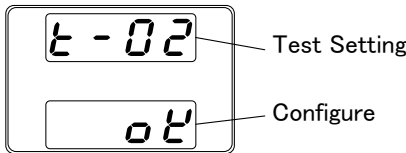

Note

Error messages: If you load a file that is not present on the USB drive "Err 002" will be displayed on the display.



2-3-5. Run Test Script

Overview

A test script can be run from the internal memory.

Steps

1. Before a test script can be run, it must first be loaded into the internal memory. Page 34
2. Configure T-01 (Run Test) Page 33
3. If there are no errors during loading, the script engine will enter the wait state. The wait state indicates that the unit is ready to execute the script.

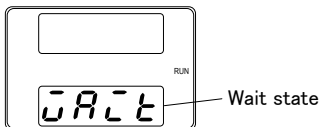

- To execute the script, press the Output key. The Output key becomes illuminated. When the script is executing, the measurement results will display as normal. The Test LED will flash.

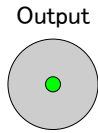

Note

When a script is running, press the Output key again to return the script engine to the wait state. Press the Output key again to run from the beginning.



Note

When the script is running, press the Test key to abort the execution of the script and return to normal operating mode. The Test LED will turn off after the script has been aborted.



Note

Error messages: If you try to run a test script from an empty memory location "Err 003" will be displayed on the display.



Note

If there is an error in the saved test script, if executed, "FILE Err" is displayed on the display screen followed by "Err = xx", and the test mode is ended. Correct the test script and save it to this unit again and execute it again.

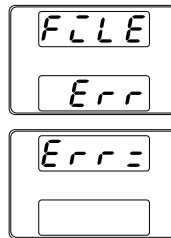

2-3-6. Export Test Script to USB

Overview

- The Export Test function saves a test file to the root directory of a USB flash drive.
- Files will be saved as tXXX.csv where XXX is the memory number 001~010 from which the test script was exported to.
 - Files of the same name on the USB flash drive will be written over.

Steps

1. Insert a USB flash drive into the front panel USB-A slot.

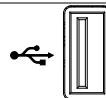

2. MS (Mass Storage) will be displayed on the screen after a few seconds if the USB drive is recognized.

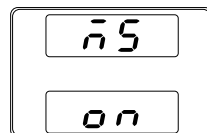

 Note If the USB drive is not recognized, check to see that the function settings for F-20 = 1 (page 45). If not, reinsert the USB flash drive. If you want to use the USB flash driver, F-29 can't be set to 3.

3. Configure T-03 (Test Export) to 0~10 (save test file to USB flash drive) T-03 Memory number 1~10 Page 33
4. Press the Voltage knob to copy the test script to the USB flash drive.

 Note Error messages: If you load a file that is not present on the USB drive "Err 003" will be displayed on the display. If you try to export a test script from an empty memory location "Err 003" will be displayed on the display.

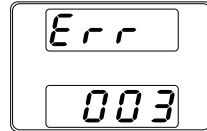

2-3-7. Remove Test Script

Overview The Remove Test function will delete a test script from the internal memory.

- Steps
1. Select T-04 (Test Remove) and Press Voltage knob to configure. Page 33
 2. The test script will be removed from the internal memory.

 Note Error messages: If you try to remove a test script from an empty memory location "Err 003" will be displayed on the display.



2-3-8. Checking the Available Memory

Overview The T-05 function displays the amount of internal memory that is left on the unit to load test scripts. The displayed units are in kilobytes (1024 bytes).

Steps Select T-05 (Available Test Memory). The available memory in kilobytes is displayed.

2-3-9. Data structure of the Test Script

The test script is text data with the extension csv.

Editing of test data in the text edit in the editor Excel or CSV file.

If you do all of the previous line, you can omit the item. Please note that you can not omit only step 1.

The line will not be interpreted to describe "memo" in the first column.

Sample file

#	A	B	C	D	E	F	G	H	I	J	K	L	M	N
1	memo	2017/10/1												
2	DisplayItems	VI												
3	CycleItems	Number	Start Step	End Step										
4	Cycle	3	1	5										
5	Step	Point	Output	Time(sec)	Voltage(V)	Current(A)	OVP(V)	OCR(A)	Bleeder	IV Mode	Vsr up(V/s)	Vsr down(V/s)	Isr up(A/s)	Isr down(A/s)
6	1	Start	On	0.5	0	4	MAX	MIN	ON	CVHS	MAX	MAX	MAX	MAX
7	2		On	0.5	0.05									
8	3		On	0.5	0.1									
9	4		On	0.5	0.15									
10	5	End	On	0.5	0.2									

```
memo,2017/10/1,,,,,,,,,,,,,
DisplayItems,VI,,,,,,,,,,,,,
CycleItems,Number,Start Step,End Step,,,,,,,,,,,,,
Cycle,3,1,5,,,,,,,,,,,,,
Step,Point,Output,Time(sec),Voltage(V),Current(A),OVP(V),OCR(A),Bleeder,IV Mode,Vsr up(V/s),Vsr down(V/s),Isr up(A/s),Isr down(A/s)
1,Start,On,0.5,0,1,MAX,MIN,ON,CVHS,MAX,MAX,MAX,MAX
2,,On,0.5,0.05,,,,,,,,,,,,,
3,,On,0.5,0.1,,,,,,,,,,,,,
4,,On,0.5,0.15,,,,,,,,,,,,,
5,End,On,0.5,0.2,,,,,,,,,,,,,
```

2-3-10. Setting values of the test Script

The number of steps is limited to free memory area, but it is up to step up to 100. Setting of time is 0.01 seconds resolution, 0.05 seconds in the shortest.

You must be careful follow-up of the setting so constrained by the setting and load conditions.

If you do not use a loop, please write the line of Cycle as "Cycle, 1,1, 2".

There is no need to enclose each item with double quotation and single quotation. Floating point numbers can not be used for numbers. It will be a fixed point or an integer.

Please do not put CR, LF, etc. code other than the end of each line.

Title	unit	value
CycleItem setting (mandatory)		The title name is "CycleItems". It becomes the title of Cycle setting.
Loop Count		The title name is "Number".
Loop Start		The title name is "Start Step".
Loop End		The title name is "End Step".
Cycle setting (mandatory)		The title name is "Cycle".
Loop Count	times	0(infinity)/1~100000000
Loop Start		1~99
Loop End		2~100

Setting Values	Unit	Value
Step (mandatory) "Step"		Title / Number
Point (mandatory) "Point"		START: 1 END: Last Point Mid: Blank
OUTPUT (mandatory) "Output"		ON/OFF
Holding time (mandatory) "Time(sec)"	sec	0, 0.05~1000000.00 Resolution: 0.01 sec 0: Skip the execution (Time error occurs total time lag will occur Skip.)
Voltage "Voltage(V)"	V	Value or MAX/MIN (See ratings)
Current "Current(A)"	A	Value or MAX/MIN (See ratings)
OVP "OVP(V)"	V	Value or MAX/MIN (See ratings)
OCP "OCP(A)"	A	Value or MAX/MIN (See ratings)
Bleeder "Bleeder"		ON/OFF
I-V Mode "IV Mode"		CVHS: CV High speed priority CCHS: CC High speed priority CVLS: CV slew rate priority CCLS: CC slew rate priority
V Slew Rate up "Vsr up(V/s)"	V/s	Value or MAX/MIN (See ratings)
V Slew Rate down "Vsr down(V/s)"	V/s	Value or MAX/MIN (See ratings)
A Slew Rate up "Isr up(V/s)"	A/s	Value or MAX/MIN (See ratings)
A Slew Rate down "Isr down(V/s)"	A/s	Value or MAX/MIN (See ratings)

Set of items that are not mandatory, you can omit the input when the same content as the previous step. Please delete any line blank.
Please refer to the data on the supplied homepage for an example of test data.
Setting the duration to 0 may not be possible depending on the version.

3. CONFIGURATION

Configuration of the PFR-100 power supplies is divided into five different configuration settings: Normal Function, Interface Configuration Settings, System Configuration Settings, Power ON Configuration and Special Function Settings. Power ON Configuration differs from the other settings in that the settings used with Power ON Configuration settings can only be set during power up. The other configuration settings can be changed when the unit is already on. This prevents some important configuration parameters from being changed inadvertently. Power ON Configuration settings are numbered F-90 to F-94 and the other configuration settings are numbered F-00 to F-61, F-71 to F-78 and F-88 to F-89. The Special Function Settings are used for calibration, firmware updated and other special functions; these functions are not supported for end-user use.

3-1. Configuration Table

Please use the configuration settings listed below when applying the configuration settings.

Normal Function settings	Settings	Setting range
Output ON delay time	F-01	0.00s~99.99s
Output OFF delay time	F-02	0.00s~99.99s
V-I mode slew rate select	F-03	0 = CV high speed priority (CVHS) 1 = CC high speed priority (CCHS) 2 = CV slew rate priority (CVLS) 3 = CC slew rate priority (CCLS)
Rising voltage slew rate	F-04	0.1V/s~100.0V/s (PFR-100L50) 0.1V/s~500.0V/s (PFR-100M250)
Falling voltage slew rate	F-05	0.1V/s~100.0V/s (PFR-100L50) 0.1V/s~500.0V/s (PFR-100M250)
Rising current slew rate	F-06	0.01A/s~20.00A/s (PFR-100L50) 0.001A/s~4.000A/s (PFR-100M250)
Falling current slew rate	F-07	0.01A/s~20.00A/s (PFR-100L50) 0.001A/s~4.000A/s (PFR-100M250)
Bleeder circuit control	F-09	0 = OFF, 1 = ON, 2 = AUTO
Buzzer ON/OFF control	F-10	0 = OFF, 1 = ON
Detection Time of OCP	F-12	0.0~2.0 sec
Current Setting Limit (I-Limit)	F-13	0 = OFF (The limit function of current setting is disabled.) 1 = ON (The limit function of current setting is enabled.)
Voltage Setting Limit (V-Limit)	F-14	0 = OFF (The limit function of voltage setting is disabled.) 1 = ON (The limit function of voltage setting is enabled.)
Memory Recall Display	F-15	0 = OFF, 1 = ON
Measurement Average Setting	F-17	0 = Low, 1 = Middle, 2 = High
Lock Mode	F-19	0 = Lock panel: Allow Output OFF 1 = Lock panel: Allow Output ON/OFF

USB/GP-IB settings		
Front panel USB State*	F-20	0 = None, 1 = Mass Storage
Rear panel USB State*	F-21	0 = None, 1 = Linking to PC
GP-IB address	F-23	0~30
Show GPIB available status*	F-25	0 = No GP-IB, 1 = GP-IB is available
Interface Select	F-29	0 = Disable, 1 = RS-232C, 2 = RS-485, 3 = USB-CDC / NO Mass Storage, 4 = GPIB, 5 = LAN SOCKET, 6 = LAN WEB
LAN Settings		
MAC address-1*	F-30	0x00~0xFF
MAC address-2*	F-31	0x00~0xFF
MAC address-3*	F-32	0x00~0xFF
MAC address-4*	F-33	0x00~0xFF
MAC address-5*	F-34	0x00~0xFF
MAC address-6*	F-35	0x00~0xFF
DHCP	F-37	0 = Disable, 1 = Enable
IP address-1	F-39	0~255, It is display only in DHCP Enable.
IP address-2	F-40	0~255, It is display only in DHCP Enable.
IP address-3	F-41	0~255, It is display only in DHCP Enable.
IP address-4	F-42	0~255, It is display only in DHCP Enable.
Subnet Mask-1	F-43	0~255, It is display only in DHCP Enable.
Subnet Mask-2	F-44	0~255, It is display only in DHCP Enable.
Subnet Mask-3	F-45	0~255, It is display only in DHCP Enable.
Subnet Mask-4	F-46	0~255, It is display only in DHCP Enable.
Gateway-1	F-47	0~255, It is display only in DHCP Enable.
Gateway-2	F-48	0~255, It is display only in DHCP Enable.
Gateway-3	F-49	0~255, It is display only in DHCP Enable.
Gateway-4	F-50	0~255, It is display only in DHCP Enable.
DNS address -1	F-51	0~255, It is display only in DHCP Enable.
DNS address -2	F-52	0~255, It is display only in DHCP Enable.
DNS address -3	F-53	0~255, It is display only in DHCP Enable.
DNS address -4	F-54	0~255, It is display only in DHCP Enable.
Web password active	F-60	0 = Disable, 1 = Enable
Web setting password	F-61	0000~9999
UART Settings		
UART Baud Rate	F-71	0 = 1200, 1 = 2400, 2 = 4800, 3 = 9600, 4 = 19200, 5 = 38400, 6 = 57600, 7 = 115200
UART Data Bits	F-72	0 = 7bit, 1 = 8bit
UART Parity	F-73	0 = None, 1 = Odd, 2 = Even
UART Stop Bit	F-74	0 = 1bit, 1 = 2bits
UART TCP	F-75	0 = SCPI, 1 = Reserve
UART Address	F-76	00~30
UART Multi-Drop control	F-77	0 = Disable, 1 = Master, 2 = Slave, 3 = Display information

UART Multi-Drop status	F-78	Displayed parameter: AA-S AA: 00~30 (Address), S: 0~1 (Off-line / On-line status)
System Settings		
Factory Set Value	F-88	0 = Disable 1 = Return to factory default settings
Show Version	F-89	0, 1 = PFR-100 version 2, 3 = PFR-100 build year 4, 5 = PFR-100 build month/day 6, 7 = Keyboard CPLD version 8, 9 = Analog-Control CPLD version
Power On Configuration Settings*		
CV Control	F-90	0 = Panel control (local) 1 = External voltage control 2 = External resistance control-Rising ↙ 3 = External resistance control-Falling ↘
CC Control	F-91	0 = Panel control (local) 1 = External voltage control 2 = External resistance control-Rising ↙ 3 = External resistance control-Falling ↘
Power-ON Output	F-92	0 = Safe Mode (Output OFF at startup) 1 = Force Mode (Output ON at startup) 2 = Auto Mode (Status before last time Power OFF)
External Output Logic Control***	F-94	0 = High ON, 1 = Low ON, 2 = Disable
Special Function*		
Special Function	F-00	0000~9999
 Note	*	It is display only. It can not be set or changed.
	**	Normally it is display only. When setting, hold down the Function key and power on.
	***	Set the Output ON / OFF control by external contact.

3-2. Normal Function Settings

Output ON Delay Time

Delays turning the output on for a designated amount of time. The Delay indicator will light when the Delay time is not 0.

Note: The Output ON Delay Time setting has a maximum deviation (error) of 20ms.

The Output ON Delay Time setting is disabled when the output is set to external control.

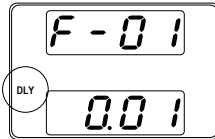

F-01 0.00s~99.99s

Output OFF Delay Time

Delays turning the output off for a designated amount of time. The Delay indicator will light when the Delay time is not 0

Note: The Output OFF Delay Time setting has a maximum deviation (error) of 20ms.

The Output OFF Delay Time setting is disabled when the output is set to external control.

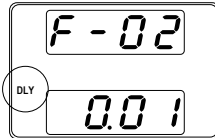

F-02 0.00s~99.99s

V-I Mode

Selects High Speed Priority or Slew Rate Priority for CV or CC mode. The voltage or current slew rate can only be edited if CC / CV Slew Rate Priority is selected. The ISR indicator will be lit for CC Slew Rate Priority and the VSR indicator will be lit for CV Slew Rate Priority.

Note: CC and CV Slew Rate Priority mode are disabled when voltage / current output is set to external control.

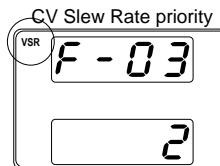
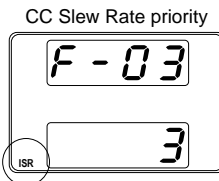

	F-03	0 = CV high speed priority 1 = CC high speed priority 2 = CV slew rate priority 3 = CC slew rate priority
Rising Voltage Slew Rate		Sets the rising voltage slew rate. Only applicable if V-I Mode is set to CV Slew Rate Priority. F-04 0.1V/s~100.0V/s (PFR-100L50) 0.1V/s~500.0V/s (PFR-100M250)
Falling Voltage Slew Rate		Sets the falling voltage slew rate. Only applicable if V-I Mode is set to CV Slew Rate Priority. F-05 0.1V/s~100.0V/s (PFR-100L50) 0.1V/s~500.0V/s (PFR-100M250)
Rising Current Slew Rate		Sets the rising current slew rate. Only applicable if V-I Mode is set to CC Slew Rate Priority. F-06 0.01A/s~20.00A/s (PFR-100L50) 0.001A/s~4.000A/s (PFR-100M250)
Falling Current Slew Rate		Sets the falling current slew rate. Only applicable if V-I Mode is set to CC Slew Rate Priority. F-07 0.01A/s~20.00A/s (PFR-100L50) 0.001A/s~4.000A/s (PFR-100M250)
Bleeder Control		Bleeder control turns ON / OFF the bleeder circuit. Bleeder circuit discharges the filter capacitors after power is turned off as a safety measure. When set to AUTO the bleeder circuit is automatically turned on when the output is turned on and turned off when the output is turned off. F-09 0 = OFF, 1 = ON, 2 = AUTO
Buzzer ON / OFF		Turns the buzzer sound on or off. The buzzer is associated with alarm sounds and keypad entry sounds. F-10 0 = OFF, 1 = ON
Detection Time of OCP		This parameter will delay the amount of time it takes to trigger the over current protection. (Resolution is 0.1s) This function can be useful to prevent current overshoot from triggering OCP. F-12 0.0~2.0 sec
Current Setting Limit (I-limit)		If the parameter sets to "1 = ON", limit the setting of output current not exceed the OCP setting value (approximately 95 % of the OCP trip point). If the parameter sets to "0 = OFF", when output current exceed the OCP value, the OCP function will be activated. F-13 0 = OFF (The limit function of current setting is disabled.) 1 = ON (The limit function of current setting is enabled.)
Voltage Setting Limit (V-limit)		If the parameter sets to "1 = ON", limit the setting of output voltage not exceed the OVP setting value (approximately 95 % of the OVP trip point). The UVL is also enabled. If the parameter sets to "0 = OFF", when output voltage exceed the OVP value, the OVP function will be activated. The UVL is also disabled.

	F-14	0 = OFF (The limit function of voltage setting is disabled.) 1 = ON (The limit function of voltage setting is enabled.)
Memory Recall Display		When the preset memory (M1, M2, M3) is recalled, the setting value will blink. F-15 0 = OFF, 1 = ON
Measurement Average Settings	F-17	Sets the level of smoothing for the average setting. 0 = Low, 1 = Middle, 2 = High
Lock Mode	F-19	Sets the behavior of the Output key when the panel lock is on. 0 = Lock panel: allow output off 1 = Lock panel: allow output on / off

3-3. USB / GP-IB Settings

Front Panel USB State	F-20	Displays the front panel USB-A port state. This setting is not configurable. 0 = None, 1 = Mass Storage
Rear Panel USB State	F-21	Displays the rear panel USB-B port state. This setting is not configurable. 0 = None, 1 = Linking to PC
GP-IB Address	F-23	Sets the GP-IB address 0~30
Show GPIB available Status	F-25	Shows the status of the GPIB option port. 0 = No GPIB, 1 = GPIB is available
Interface Select	F-29	Enables or disables the Interface port. Only one interface can be used at the same time. 0 = Disable, 1 = RS232, 2 = R485, 3 = USB-CDC / NO Mass Storage, 4 = GPIB, 5 = LAN SOCKET, 6 = LAN WEB

3-4. LAN Settings

MAC Address 1~6	F-30~F-35	Displays the MAC address 1~6. This setting is not configurable. 0x00~0xFF
DHCP	F-37	Turns DHCP on or off. 0 = Disable, 1 = Enable
IP Address 1~4	F-39~F-42	Sets the default IP address. IP address 1~4 splits the IP address into four sections. 0~255
Subnet Mask 1~4	F-43~F-46	Sets the subnet mask. The subnet mask is split into four parts. 0~255
Gateway 1~4	F-47~F-50	Sets the gateway address. The gateway address is split into four parts. 0~255

DNS Address 1~4	<p>Sets the DNS address. The DNS address is split into four parts.</p> <p>F-51~F-54 0~255</p>
Web Password active	<p>Turns a web password on / off.</p> <p>F-60 0 = Enable, 1 = Disable</p>
Web Password	<p>Sets the Web password.</p> <p>F-61 0000~9999</p>

3-5. UART Settings

UART Baud Rate	<p>Sets the UART baud rate.</p> <p>F-71 0 = 1200, 1 = 2400, 2 = 4800, 3 = 9600, 4 = 19200, 5 = 38400, 6 = 57600, 7 = 115200</p>
UART Data Bits	<p>Sets the number of data bits.</p> <p>F-72 0 = 7bits, 1 = 8bits</p>
UART Parity	<p>Sets the parity.</p> <p>F-73 0 = None, 1 = Odd, 2 = Even</p>
UART Stop Bit	<p>Sets the number of stop bits.</p> <p>F-74 0 = 1bit, 1 = 2bits</p>
UART TCP	<p>UART transmission control protocol TCP settings.</p> <p>F-75 0 = SCPI</p>
UART Address	<p>Sets the UART address. This is used to set the address of a unit when using Multi-Drop remote control.</p> <p>F-76 00~30</p>
UART Multi-Drop control	<p>Set the master / slave / display-information parameters of a unit when using Multi-Drop remote control.</p> <p>F-77 0 = Disable, 1 = Master, 2 = Slave, 3 = Display Information</p>
UART Multi-Drop status	<p>Displays the Multi-Drop status on the master unit for each slave unit belonging to the Multi-Drop bus.</p> <p>F-78 Displayed parameter: AA-S AA: 00~30 (Address), S: 0~1 (Off-line / On-line status)</p>

3-6. System Settings

Factory Default Configuration	<p>Returns the PFR-100 to the factory default settings. See page 85 for a list of the default settings.</p> <p>F-88 0 = Disable, 1 = Return to factory default settings.</p>
Show Version	<p>Displays the PFR-100 version number, build date, keyboard version, analog-control version, kernel build date</p>

F-89	0, 1	= PFR-100 version
	2, 3	= PFR-100 build year
	4, 5	= PFR-100 build month/day
	6, 7	= Keyboard CPLD version
	8, 9	= Analog-Control CPLD version

3-7. Power On Configuration Settings

CV Control	Sets the constant voltage (CV) control mode between local and external voltage/resistance control. For external voltage control, see page 52 (External Voltage Control of Voltage Output) and page 55 (External Resistance Control of Voltage Output).	
F-90	0	= Panel control (local)
	1	= External voltage control
	2	= External resistance control (Ext-R \searrow 10k Ω = V _o , max)
	3	= External resistance control (Ext-R \searrow 10k Ω = 0)
CC Control	Sets the constant current (CC) control mode between local and external voltage/resistance control. For details on external voltage control, see page 54 (External Voltage Control of Current Output) and page 57 (External Resistance Control of Current Output).	
F-91	0	= Panel control (local)
	1	= External voltage control
	2	= External resistance control (Ext-R \searrow 10k Ω = I _o , max)
	3	= External resistance control (Ext-R \searrow 10k Ω = 0)
Power-ON Output	Sets the power supply to turn the output on or off at power up.	
F-92	0	= OFF at startup, 1 = On at startup
	t001 ~ t010	= run testscript t001 ~ t010
External Output Logic Control	Sets the external output logic as active high or low, or disables the external output control function.	
F-94	0	= High ON, 1 = Low ON, 2 = Disable

3-8. Special Function

Special Function	The special function setting is used to access calibration, firmware updates and other special functions. The special function setting has a password that is used to access the special function menu.	
F-00	0000~9999	

3-9. Setting Normal Function Settings

The Normal Function settings, F-01~F-61, F-71~F-78, F-88, F-89 can be easily configured with the Function key.

- Ensure the load is not connected.
- Ensure the output is off.
- Function settings F-90~F-94 can only be viewed.



Note

Function setting F-20, F-21, F-25, F-30~F-35, F-78, F-89 can only be viewed, not edited.

Configuration settings F-90~F-94 cannot be edited in the Normal Function Settings. Use the Power On Configuration Settings. See page 49 for details

Steps

1. Press the Function key. The function key will light up.



2. The display will show F-01 on the top and the configuration setting for F-01 on the bottom



3. Rotate the Voltage knob to change the F setting.

Range F-00~F-61, F-71~F-78,
F-88~F-94

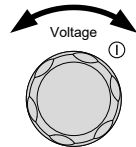

4. Use the Current knob to set the parameter for the chosen F setting.

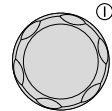

5. Press the Voltage knob to save the configuration setting. ConF will be displayed when it is configuring.

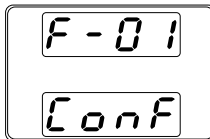
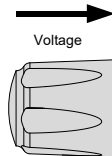

Exit

Press the Function key again to exit the configuration settings. The function key light will turn off.



3-10. Setting Power On Configuration Settings

Background The Power On configuration settings can only be changed during power up to prevent the configuration settings being inadvertently changed.

- Ensure the load is not connected.
- Ensure the power supply is off.

Steps 1. Hold the Function key whilst turning the power on.

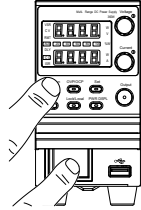

2. The display will show F-90 on the top and the configuration setting for F-90 on the bottom.

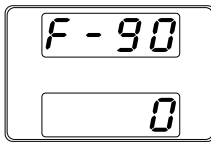

3. Rotate the Voltage knob to change the F setting.

Range F-90~F-94

4. Use the Current knob to set the parameter for the chosen F setting.

5. Press the Voltage knob to save the configuration setting. Conf will be displayed when it is configuring.

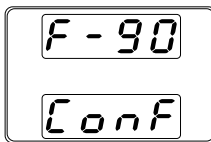
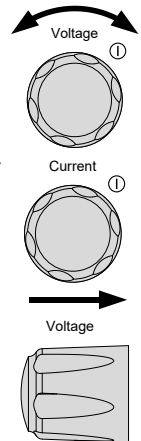

Exit Cycle the power to save and exit the configuration settings.

4. ANALOG CONTROL

The Analog Control chapter describes how to control the voltage or current output using an external voltage or resistance, monitor the voltage or current output as well as remotely turning off the output or shutting down the power supply.

4-1. Analog Remote Control Overview

The PFR-100 power supply series have a number of analog control options. The Analog Control connectors are used to control output voltage and current using external voltage or resistance. The power supply output and power switch can also be controlled using external switches.

4-1-1. Analog Control Connector (J1) Overview

Overview

The Analog Control Connector (J1) is a standard Mil 20 pin connector (OMRON XG4C plug). Use an OMRON XG5M socket as the mating socket. The connector is used for all analog remote control. The pins used determine what remote control mode is used.



WARNING

To prevent electric shock, ensure that the cover for the Analog Control Connector is used when the connector is not in use.

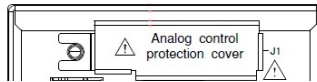

Pin Assignment

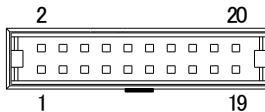

The mounting of the wire to the contact, in order to improve the reliability, please use the (OMRON) special tool XY2B-7006. In addition, the application wire rod is twist line AWG28 - AWG26, external form $\Phi 1.1$ - $\Phi 1.3$.

Specifically, please review an instruction manual of XY2B-7006. For details, please confirm the operation manual of XY2B-7006.

In the case of faulty wiring or wiring change, please use the (OMRON) special tool XY2E-0001 that is withdrawn from the housing contact. For details, please confirm the operation manual of XY2E-0001.

Pin name	Pin number	Description
Status COM	1	This is the common line for the status signal pins 2 to 6.
Alarm Status	2	On when a protection function (OVP, HW_OVP, OCP, OHP, AC_FAIL or OPP) has been activated or when an output shutdown signal is being applied (open-collector photocoupler output).*
CV Status	3	This line is On when the PFR-100 is in CV mode (open-collector photocoupler output).*
PWR Off Status	4	Outputs a low level signal when power is turned off. (open-collector photocoupler output).*
CC Status	5	This line is On when the PFR-100 is in CC mode (open-collector photocoupler output).*
OUT on Status	6	On when the output is on (open-collector photocoupler output).*
N.C.	7	Not connected.
N.C.	8	Not connected.
N.C.	9	Not connected.
N.C.	10	Not connected.
Alarm Clear	11	Alarm clear line. Alarms are cleared when a low TTL signal is applied.
Shutdown	12	Output shutdown control line. The output is turned off when a low TTL signal is applied.
A COM	13	This is the common line for external signal pins 11, 12, 14, 16, 18, 19, and 20. During remote sensing, this is the negative electrode (-S) of sensing input. When remote sensing is not being performed, this is connected to the negative output.
Out On/Off CONT	14	Output on/off line. On when set to a low TTL signal, Off when set to a high TTL signal. (F-94: 1) On when set to a high TTL signal, Off when set to a low TTL signal. (F-94: 0)
A COM	15	This is the common line for external signal pins 11, 12, 14, 16, 18, 19, and 20. During remote sensing, this is the negative electrode (-S) of sensing input. When remote sensing is not being performed, this is connected to the negative output.
EXT-V/R CV CONT	16	This line uses an external voltage or resistance to control the output voltage. External voltage control (F-90: 1); External resistor control (F-90: 2, F-90: 3) 0 to 10V or 0 to 10kΩ or 10k to 0Ω; 0% to 100% of the rated output voltage.
A COM	17	This is the common line for external signal pins 11, 12, 14, 16, 18, 19, and 20. During remote sensing, this is the negative electrode (-S) of sensing input. When remote sensing is not being performed, this is connected to the negative output.

EXT-V/R CC CONT	18	This line uses an external voltage or resistance to control the output current. External voltage control (F-91: 1); External resistor control (F-91: 2, F-91: 3) 0 to 10V or 0 to 10kΩ or 10k to 0Ω; 0% to 100% of the rated output current.
I MON	19	Output current monitor. 0% to 100% of the rated output current is generated as a voltage between 0V and 10V.
V MON	20	Output voltage monitor. 0% to 100% of the rated output voltage is generated as a voltage between 0V and 10V.

*Open collector output: Maximum voltage of 30V and maximum current of 8mA. The common line for the status pins is floating (isolated voltage of 60V or less), it is isolated from the control circuit.

4-1-2. External Voltage Control of Voltage Output

Background

External voltage control of the voltage output is accomplished using the analog control connector on the rear panel. A voltage of 0~10V is used to control the full scale voltage of the instrument, where:

Output voltage = full scale voltage × (external voltage/10)

Connection 1

When connecting the external voltage source to the analog control connector, use shielded or twisted paired wiring.

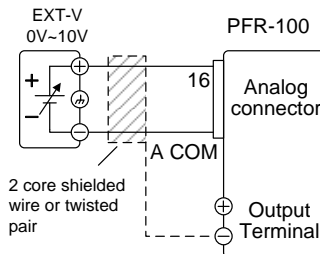

Pin 16 → EXT-V (+)

A COM (either Pin 13, 15 or 17) → EXT-V (-)

Wire shield → negative (-) output terminal

Connection 2 alt. shielding

If the wire shield needs to be grounded at the voltage source (EXT-V), then the shield cannot also be grounded at the negative (-) terminal output of the PFR-100 power supply. This would short the output.

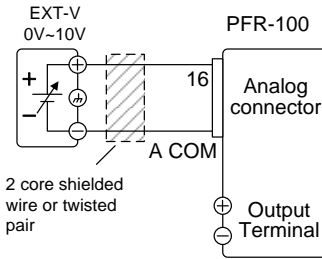

Pin 16 → EXT-V(+)
 A COM (either Pin 13, 15 or 17) → EXT-V (-)
 Wire shield → EXT-V ground (GND)

- Panel operation
1. Connect the external voltage according to the connection diagrams above
 2. Set the F-90 power on configuration setting to 1 (CV control - Ext voltage).
 Be sure to cycle the power after the power on configuration has been set.
 3. Press the Function key and confirm the new configuration settings (F-90 = 1).
 4. Press the Output key. The voltage can now be controlled with the External voltage.

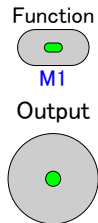

 **WARNING**

Be careful about the grounding voltage of the outside voltage.

 **CAUTION**

Ensure no more than 10.5 volts are input into the external voltage input. Ensure the voltage polarity is correct when connecting the external voltage.

 **Note**

The input impedance for external voltage control is a high impedance OPA input.

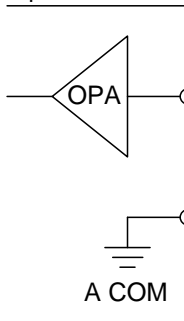

Use a stable voltage supply for the external voltage control.



Note

CV and CC Slew Rate Priority are disabled for V-I mode (F-03) when using external voltage control. See the Normal Function Settings on page 43. During external voltage control, the output on and off delay times are disabled.

4-1-3. External Voltage Control of Current Output

Background

External voltage control of the current output is accomplished using the MIL-26 connector on the rear panel. A voltage of 0~10V is used to control the full scale current of the instrument, where:

Connection 1

Output current = full scale current × (external voltage/10)
When connecting the external voltage source to the MIL connectors, use shielded or twisted paired wiring.

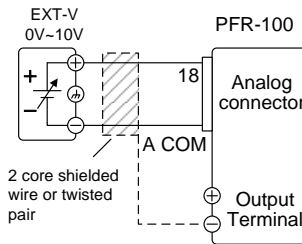

Pin 18 → EXT-V (+)

A COM (either Pin 13, 15 or 17) → EXT-V (-)

Wire shield → negative (-) output terminal

Connection 2
alt. shielding

If the wire shield needs to be grounded at the voltage source (EXT-V), then the shield cannot also be grounded at the negative (-) terminal output of the PFR-100 power supply. This would short the output.

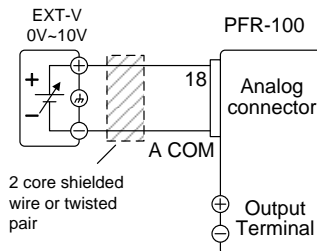

Pin 18 → EXT-V (+)

A COM (either Pin 13, 15 or 17) → EXT-V (-)

Wire shield → EXT-V ground (GND)

Steps

1. Connect the external voltage according to the connection diagrams above.
2. Set the F-91 power on configuration setting to 1 (CC control – Ext voltage).

Page 49

Be sure to cycle the power after the power on configuration has been set.

3. Press the Function key and confirm the new configuration settings (F-91 = 1).
4. Press the Output key. The current can now be controlled with the External voltage.

Function



M1

Output



WARNING

Be careful about the grounding voltage of the outside voltage.



CAUTION

Ensure the voltage polarity is correct when connecting the external voltage. Ensure no more than 10.5 volts are input into the external voltage input.



Note

The input impedance for external voltage control is a high impedance OPA input.

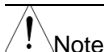
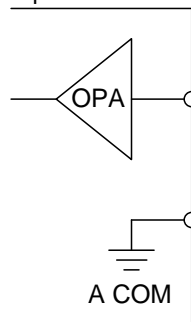

Note

Use a stable voltage supply for the external voltage control. CV and CC Slew Rate Priority are disabled for V-I mode (F-03) when using external voltage control. See the Normal Function Settings on page 43. During external voltage control, the output on and off delay times are disabled.

4-1-4. External Resistance Control of Voltage Output

Background

External resistance control of the voltage output is accomplished using the analog connector on the rear panel. A resistance of 0kΩ~10kΩ is used to control the full scale voltage of the instrument.

The output voltage (0 to full scale) can be controlled with the external resistance going up (Ext-R \searrow) 0kΩ~10kΩ (10kΩ = V_o , max) or down (Ext-R \swarrow) 10kΩ~0kΩ (10kΩ = 0).

For 0kΩ~10kΩ:

Output voltage = full scale voltage × (external resistance/10)

For 10kΩ~0kΩ:

Output voltage = full scale voltage × ((10-external resistance)/10)

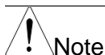

Note

The Ext-R ∇ configuration is recommended for safety reasons. In the event that the cables become accidentally disconnected, the voltage output will drop to zero. Under similar circumstances using Ext-R \sphericalangle , an unexpected high voltage would be output.

If switches are used to switch between fixed resistances, use switches that avoid creating open circuits. Use short-circuit or continuous resistance switches.

Connection

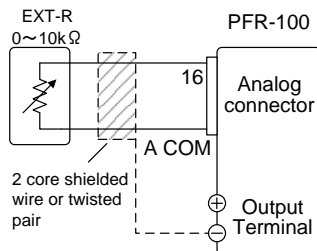

Pin 16 → EXT-R

A COM (either Pin 13, 15 or 17) → EXT-R

Wire shield → negative (-) output terminal

Steps

1. Connect the external resistance according to the connection diagrams above.
2. Set the F-90 (CV Control) configuration settings to 2 for Ext-R \sphericalangle or 3 for Ext-R ∇ . Page 49
Be sure to cycle the power after the power on configuration has been set.
3. Press the Function key and confirm the new configuration settings (F-90 = 2 or 3).
4. Press the Output key. The voltage can now be controlled with the External resistance.



WARNING

Ensure the resistor(s) and cables used exceed the isolation voltage of the power supply. For example: insulation tubes with a withstand voltage higher than the power supply can be used.

When choosing an external resistor ensure the resistor can withstand a high degree of heat.



Note

For external resistors, use a metal film resistor or a wire wound resistor, such as a 1/2W or higher, low temperature coefficient and secular change.

Please connect the wiring with 2 core shielding line or twisted pair cable briefly. Please do not be affected by foreign noises.

CV and CC Slew Rate Priority are disabled for V-I mode when using external resistance control. See the Normal Function settings on page 43.

During outside voltage control, invalidity becomes the output on/off delay time.

4-1-5. External Resistance Control of Current Output

Background

External resistance control of the current output is accomplished using the analog connector on the rear panel. A resistance of 0kΩ~10kΩ is used to control the full scale voltage of the instrument.

The output current (0 to full scale) can be controlled with the external resistance going up (Ext-R \searrow) 0kΩ~10kΩ (10kΩ = V_o , max) or down (Ext-R \swarrow) 10kΩ~0kΩ (10kΩ = 0).

For 0kΩ~10kΩ:

Output current = full scale current \times (external resistance/10)

For 10kΩ~0kΩ:

Output current = full scale current \times ([10-external resistance]/10)



Note

The Ext-R \swarrow configuration is recommended for safety reasons. In the event that the cables become accidentally disconnected, the current output will drop to zero. Under similar circumstances using Ext-R \searrow , an unexpected high current would be output.

If switches are used to switch between fixed resistances, use switches that avoid creating open circuits. Use short-circuit or continuous resistance switches.

Connection

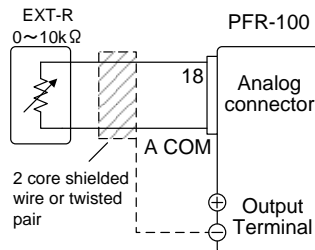

Pin 18 \rightarrow EXT-R

A COM (either Pin 13, 15 or 17) \rightarrow EXT-R

Wire shield \rightarrow negative (-) output terminal

Steps

1. Connect the external resistance according to the connection diagrams above.
2. Set the F-91 (CC Control) configuration settings to 2 for Ext-R \swarrow or 3 for Ext-R \searrow .
Be sure to cycle the power after the power on configuration has been set.
3. Press the Function key and confirm the new configuration settings (F-91 = 2 or 3).
4. Press the Output key. The current can now be controlled with the External resistance.

Page 49

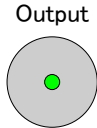

WARNING

Ensure the resistor(s) and cables used exceed the isolation voltage of the power supply. For example: insulation tubes with a withstand voltage higher than the power supply can be used.

When choosing an external resistor ensure the resistor can withstand a high degree of heat.



Note

For external resistors, use a metal film resistor or a wire wound resistor, such as a 1/2W or higher, low temperature coefficient and secular change.

Please connect the wiring with 2 core shielding line or twisted pair cable briefly. Please do not be affected by foreign noises.

CV and CC Slew Rate Priority are disabled for V-I mode when using external resistance control. See the Normal Function settings on page 43.

During outside voltage control, invalidity becomes the output on/off delay time.

4-1-6. External Control of Output

Background

The output can be turned on or off externally using a switch. The analog control connector can be set to turn the output on from a high or low signal. The voltage across pins 2 and 24 are internally pulled to +5V \pm 5% @ 500uA with 10k Ω pull-up resistor. A short (closed switch) produces a low signal.

By F-94 (output on logic setting by the outside point of contact), it is selectable whether you let the output turn on by short / opening. In addition, please consider setting of F-92 when you constitute the logic in combination with output setting in the power on.

When set to High = On (F-94: 0), the output is turned on when A COM - Out On/Off CONT (pin 14) are open.
 When set to Low = On (F-94: 1), the output is turned on when A COM - Out On/Off CONT (pin 14) are shorted.
 Disable this function when F-94: 2.

Connection

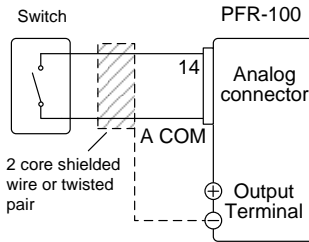

Pin 14 → Switch
 A COM (either Pin 13, 15 or 17) → Switch
 Wire shield → negative (-) output terminal

Steps

1. Connect the external switch according to the connection diagrams above.
 Set F-94 (External output logic) in the power Page 49 on configuration settings to 0 (High = On) or 1 (Low = On).
 Be sure to cycle the power after setting the power on configuration settings.
2. Press the Function key and confirm the new configuration settings. (F-94 = 0 or 1)
3. The switch is now ready to set the output on or off.



WARNING

Ensure the cables used and the switch exceed the isolation voltage of the power supply.
 For example: insulation tubes with a withstand voltage higher than the power supply can be used.

Note

When using a switch over long distances, please use a switch relay to extend the line from the coil side of the relay.

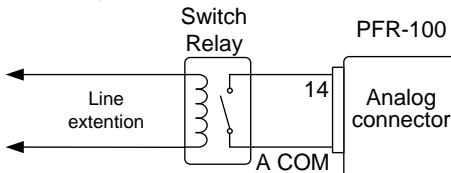

If a single switch control is to be used for multiple units, please isolate each instrument. This can be achieved by using a relay.

Note

Messages:
 If the pin 14 is low (0) at F-94 = 0 (High = ON), pressing the Output key displays "MSG 001" on the display.
 If the pin 14 is high (1) at F-94 = 1 (Low = ON), pressing the Output key displays "MSG 002" on the display.

Output off (High=on)

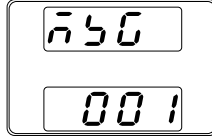

Output off (Low=on)

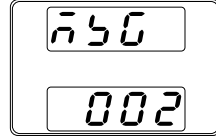

Note

Output ON/OFF Delay Time (F-01, F-02) are disabled when the output is set to external control. See the normal function settings on page 43 for details.

4-1-7. External control of Shutdown

Background

The output of the power supplies can be configured to shut down via an external switch. The voltage across pins 12 and A COM are internally pulled to +5V \pm 5% @ 500uA with 10k Ω pull-up resistor. The output is turned off when a low TTL level signal is applied. To recover, return the pin between pin 12 and A COM to open and hold down ALM_CLR key or turn the power off and on again. This function does not need to be enabled in the configuration settings.



Note

This function can not turn off the power. It is only output off.

Connection

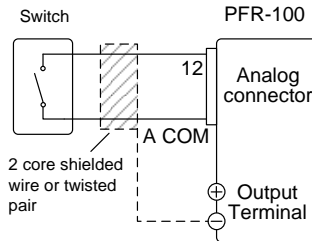

Pin 12 \rightarrow Switch

A COM (either Pin 13, 15 or 17) \rightarrow Switch

Wire shield \rightarrow negative (-) output terminal

Steps

1. Connect the external switches according to the connection diagrams above.
2. The switch will now shut down the power supply when shorted.

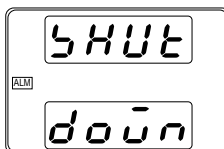

! WARNING

Ensure the cables and switch used exceed the isolation voltage of the power supply.
For example: insulation tubes with a withstand voltage higher than the power supply can be used.

! Note

When using a switch over long distances, please use a switch relay to extend the line from the coil side of the relay.

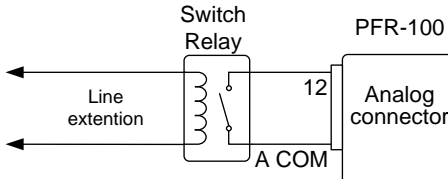

Basically, it is recommended to connect an external contact in an isolated floating state for each unit when controlling with external contacts.

If a single switch control is to be used for multiple units, please isolate each instrument. This can be achieved by using a relay.

A COM is electrically connected to the sensing negative pole (-S). Wiring should be done so that there is no potential difference between the -S of each unit.

4-1-8. External control of Alarm Clear

Background

The output of the power supplies can be configured to clear the alarm via an external switch. The voltage across pins 11 and A COM are internally pulled to +5V \pm 5% @ 500uA with 10k Ω pull-up resistor. The alarm is cleared when a low TTL level signal is applied.

This function does not need to be enabled in the configuration settings.

! Note

This function can not turn off the power. It is only output off.

Connection

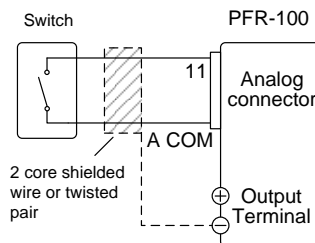

Pin 11 \rightarrow Switch

A COM (either Pin 13, 15 or 17) \rightarrow Switch

Wire shield \rightarrow negative (-) output terminal

Steps

1. Connect the external switches according to the connection diagrams above.
2. Generate some alarm, set the alarm condition, short the switch, and confirm that the alarm is cleared.



WARNING

Ensure the cables and switch used exceed the isolation voltage of the power supply.
For example: insulation tubes with a withstand voltage higher than the power supply can be used.



Note

When using a switch over long distances, please use a switch relay to extend the line from the coil side of the relay.

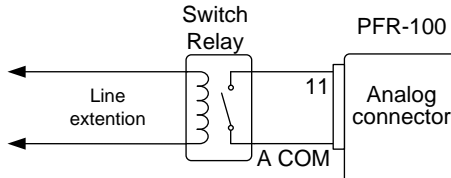

If a single switch control is to be used for multiple units, please isolate each instrument. This can be achieved by using a relay.

4-2. Remote Monitoring

The PFR-100 power supplies have remote monitoring support for current and voltage output. They also support monitoring of operation and alarm status.

4-2-1. External Voltage and Current Monitoring

Background

The analog connector (J1) is used to monitor the current (IMON) or voltage (VMON) output.
An output of 0~10V represents the voltage or current output of 0~ rated current/voltage output.
 $IMON = (\text{current output}/\text{full scale}) \times 10$
 $VMON = (\text{voltage output}/\text{full scale}) \times 10$
This function does not need to be enabled in the configuration settings.

VMON Connection

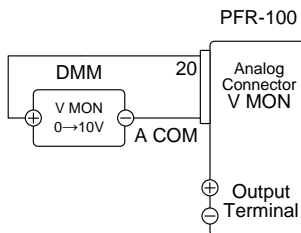

A COM (either Pin 13, 15 or 17) → Neg (-)
Pin 20 → Pos (+)

IMON Connection

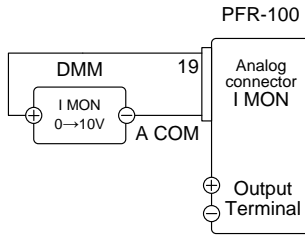

A COM (either Pin 13, 15 or 17) → Neg (-)
Pin 19 → Pos (+)



WARNING

As for the monitor signal, there might be the electric shock in the floating output or the series driving for output terminal electric potential.



CAUTION

Ensure IMON (pin 19) and VMON (pin 20) are not shorted together. This will cause damage to the unit.



Note

Maximum current is 5mA. Ensure the sensing circuit has an input impedance greater than 1MΩ.
The monitor outputs are strictly DC and should not be used to monitor analog components such as transient voltage response or ripple etc.

4-2-2. External Operation and Status Monitoring

Background

The analog connector can also be used to monitor the status operation and alarm status of the instrument. The pins are isolated from the power supply internal circuitry by photo couplers. Status Com (Pin 1) is a photo coupler emitter output, whilst pins 2~6 are photo coupler collector outputs. A maximum of 30V and 8mA can be applied to each pin.

Name and Pin	Description
Status COM 1	Common (photo coupler emitter) for the status signal pins 2 to 6.
Alarm Status 2	On when a protection function (OVP, HW_OVP, OCP, OHP, AC_FAIL or OPP) has been activated or when an output shutdown signal is being applied (open-collector photocoupler output).
CV Status 3	This line is On when the PFR-100 is in CV mode (open-collector photocoupler output).
PWR Off Status 4	Outputs a low level signal when power is turned off. (open-collector photocoupler output).

CC Status	5	This line is On when the PFR-100 is in CC mode (open-collector photocoupler output).
Out On Status	6	On when the output is on (open-collector photocoupler output).

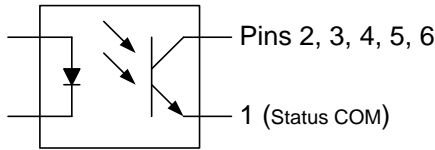

Timing diagrams Below are 4 example timing diagrams covering a number of scenarios. Note that pins 2–6 are all active low.

CV MODE: Output turned on The diagram below shows the timing diagram when the output is turned on when the PFR-100 is set to CV mode.

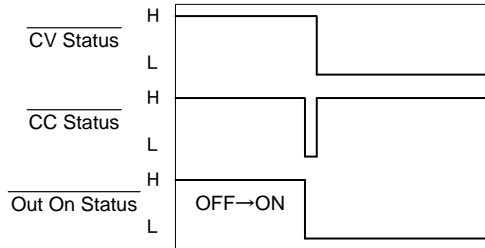

CV MODE: Output turned off The diagram below shows the output status lines when the output is turned off in CV mode.

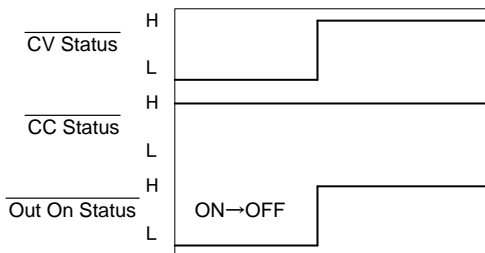

CC MODE: Output turned on

The diagram below shows the timing diagram when the output is turned on when the PFR-100 is set to CC mode.

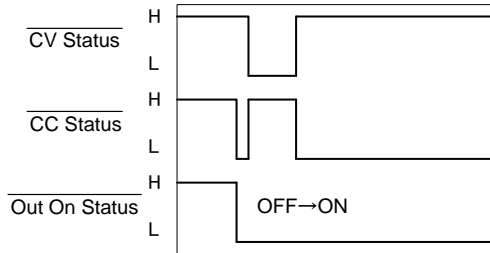

CC MODE: Output turned off

The diagram below shows the output status lines when the output is turned off in CC mode.

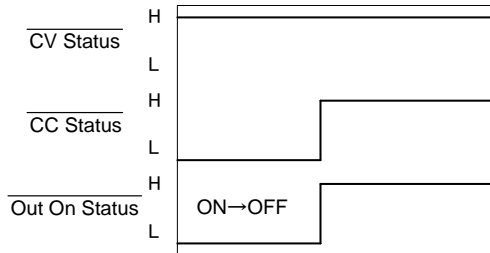

5. Communication Interface

This chapter describes basic configuration of IEEE488.2 based remote control. For a command list, refer to the programming manual.

5-1. USB Interface

5-1-1. USB Remote Interface

 Note	When using the USB Remote Interface, The USB port on the front panel will become disabled and fail to be used.	
USB Configuration	PC side connector	Type A, host
	PFR-100 side connector	Rear panel Type B, slave
	Speed	1.1 (full speed)
	USB Device Class	USB-CDC
Steps	<ol style="list-style-type: none"> 1. Connect the USB cable to the rear panel USB B port. 2. Press the Function key to enter the Normal configuration settings and select F-29 (Interface port). F-29 = 3 (USB-CDC). 3. Check to see that the USB is detected by PFR-100. The F-21 setting indicates the rear USB port. <ul style="list-style-type: none"> F-21 = 0 Indicates the rear USB port is not detected. F-21 = 1 Indicates the rear USB port is available. 4. The RMT indicator will turn on when a remote connection has been established. 	

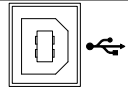

Page 43

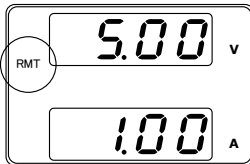

5. When the PC correctly recognizes "PFR", the USB driver is installed and registered as a COM port. Open the device manager and check the port. If it is not recognized correctly, installation of the USB driver is necessary. Since this unit is displayed on "other device", right click on the device and update the driver. Please copy the downloaded USB driver from our HP to the appropriate folder and specify the search destination. If the USB driver can not be installed because the PC's security boot function is enabled, please turn off the function. For windows10, driver installation is not required and is recognized by default.

5-1-2. USB-CDC Remote Control Function Check

Please note that the port settings may not be confirmed if the device driver is not used for this unit.

Please prepare the Terminal application (such as PuTTY or RealTerm). Serial communication settings are as follows.

Baud rate : 9600 bps Data bits : 8 bits
Parity bit : None Stop bits : 1 bit
Flow control : None

Run this query command via the terminal after the instrument has been configured for USB remote control.

*IDN?

This should return the Manufacturer, Model name, Serial number, and Firmware version in the following format.

TEXIO,PFR-100L50,TW1234567,01.01.12345678

Manufacturer : TEXIO
Model name : PFR-100L50
Serial number : TW1234567
Firmware version : 01.01.12345678

Termination character of commands and queries use the ^j (LF: Line Feed).



Note

For further details, please see the programming manual.

5-2. GPIB Interface

5-2-1. GPIB Remote Interface

To use GPIB, you must select a model with a GPIB. This is a factory installed option and cannot be installed the end-user. Only one GPIB address can be used at a time.

-
- Configure GPIB
1. Ensure the PFR-100 is off before proceeding.
 2. Connect the GPIB cable (part number: GTL-258) from a GPIB controller to the GPIB port on the PFR-100.
 3. Turn the PFR-100 on.
 4. Press the Function key to enter the Normal configuration settings. Page 48
 5. Set the following GPIB settings.
F-29 = 4 Enable the GPIB port
F-23 = 0~30 Set the GPIB address (0~30/ Default : 8)
 6. Check to see the GPIB option is detected by the PFR-100. The F-25 setting indicates the GPIB port status.
F-25 = 0 Indicates that the GPIB port is not detected.
F-25 = 1 Indicates that the GPIB port is available.
 7. The RMT indicator will turn on when a remote connection has been established.

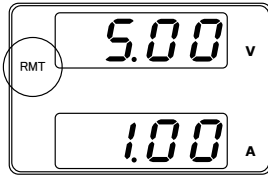

- GPIB constraints
- Maximum 15 devices altogether, 20m cable length, 2m between each device.
 - Unique address assigned to each device.
 - At least 2/3 of the devices turned On.
 - No loop or parallel connection.

5-2-2. GPIB Function Check

- | | |
|---------------------|--|
| Background | To test the GPIB functionality, National Instruments Measurement and Automation Explorer can be used. This program is available on the NI website, www.ni.com , via a search for the NI-488.2 page, or “downloads” at the following URL, http://www.ni.com/ |
| Requirements | PC Operating System(OS): Windows 7 or later |
| Functionality check | <ol style="list-style-type: none"> 1. Start the NI Measurement and Automation Explorer (NI-MAX) program. Using Windows, press:
<i>Start ->All Programs ->National Instruments ->Measurement & Automation</i> |



- Display and operated by a version of NI-MAX is different. Please operate in accordance with the version you are using.
1. From the Configuration panel access;
My system>Devices and Interface>GPIB
 2. Press *Scan for Instruments*.

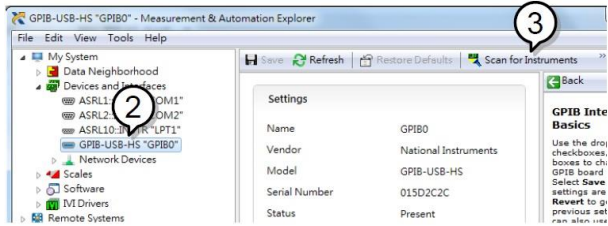

3. Select the device (GPIB address of PFR-100) that now appears in the *System>Devices and Interfaces > GPIB-USB-HS "GPIBX"* node.
4. Click on the *VISA Properties* tab on the bottom.
5. Click *Open VISA Test Panel*.

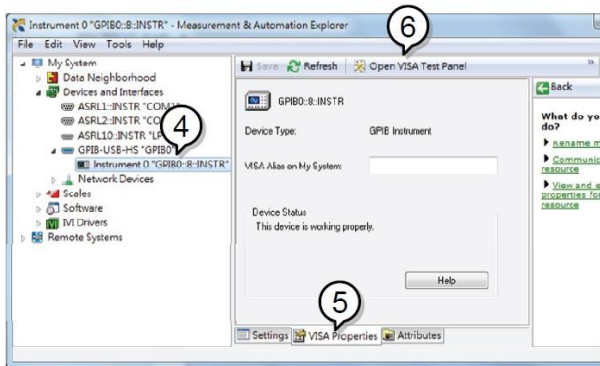

6. Click on *Configuration*.
7. Click on the *GPIB Settings* tab and confirm that the GPIB settings are correct.

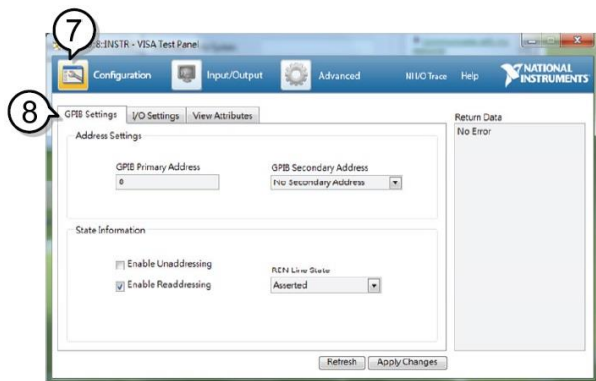

8. Click on the *I/O Settings* tab.

9. Make sure the *Enable Termination Character* check box is checked, and the terminal character is \n (Value: xA).
10. Click *Apply Changes*.

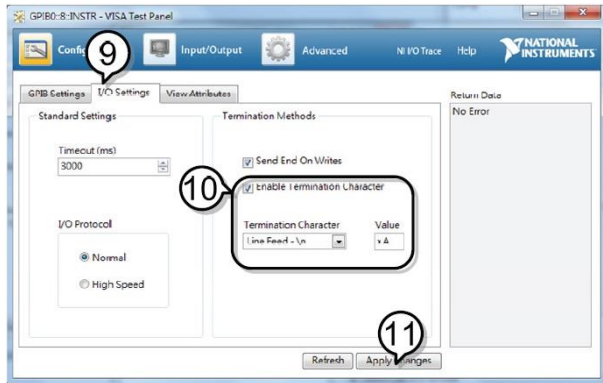

11. Click on *Input/Output*.
12. Click on the *Basic I/O* tab.
13. Enter *IDN? in the *Select or Enter Command* drop down box.
14. Click *Query*.
15. The *IDN? query will return the Manufacturer, model name, serial number and firmware version in the dialog box.

TEXIO, PFR-100L50, TW1234567, 01.01.12345678

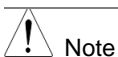
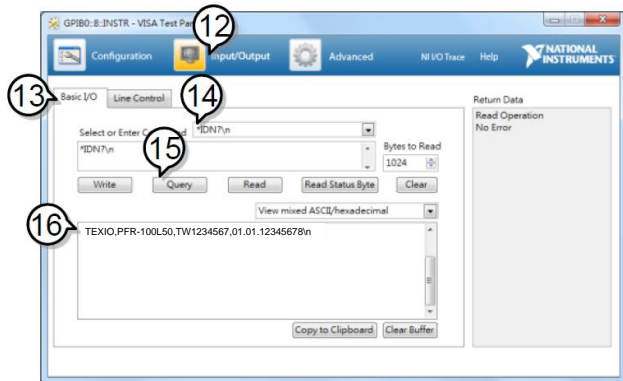

Note

For further details, please see the programming manual.

5-3. LAN Interface

The Ethernet interface can be configured for a number of different applications. Ethernet can be configured for basic remote control or monitoring using a web server or it can be configured as a socket server.

The PFR-100 series supports both DHCP connections so the instrument can be automatically connected to an existing network or alternatively, network settings can be manually configured.

Ethernet configuration	For details on how to configure the Ethernet settings, please see the configuration chapter on page 45.	
Parameters	DHCP Enable/Disable	MAC Address (display only)
	Subnet Mask	IP Address
	DNS Address	Gateway
	Web Password Enable/Disable	
	Web Enter Password	0000~9999(Default 0000)
	Socket port:	2268(Fixed)

5-3-1. Web Server Configuration

Configuration This configuration example will configure the PFR-100 as a web server and use DHCP to automatically assign an IP address to the PFR-100.

1. Connect an Ethernet cable from the network to the rear panel Ethernet port.

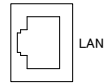

2. Press the Function key to enter the Normal configuration settings.

Page 48

Set the following LAN settings:

- | | |
|------------------|--|
| F-29 = 6 | Interface port select & Turn LAN (Web) on |
| F-37 = 1 | Enable DHCP |
| F-60 = 0 or 1 | Set to 0 to disable web password, set to 1 to enable web password. |
| F-61 = 0000~9999 | Set the web password |

3. The LAN indicator will turn on when a network cable is plugged in.



Note

It may be necessary to cycle the power or refresh the web browser to connect to a network.

5-3-2. Web Server Remote Control Function Check

Functionality
check

Enter the IP address of the power supply in a web browser after the instrument has been configured as a web server. (page 71)

The web server allows you to monitor the function settings of the PFR-100.

You can check the IP address by checking F-39 to F-42.

F-39 = AAA IP Address part 1 of 4

F-40 = BBB IP Address part 2 of 4

F-41 = CCC IP Address part 3 of 4

F-42 = DDD IP Address part 4 of 4

http://AAA.BBB.CCC.DDD

The web browser interface appears.

[PFR-100 Series Web Control Pages](#)
 [Visit Our Site](#)
 [Support](#)
 [Contact Us](#)

<ul style="list-style-type: none"> • [Welcome Page] <hr/> • [Network Configuration] <hr/> • [Measurement] <hr/> • [Normal Function] <hr/> • [Power On Configuration] 	<p style="font-size: small; margin: 0;">Thanks For Your Using. Use the left menu to select the features you need. More How-to. Please refer to user manual.</p> <p style="margin: 0;">System Information</p> <table border="1" style="width: 100%; border-collapse: collapse;"> <tr><td style="font-size: x-small;">Manufacturer :</td><td style="font-size: x-small;">TEXIO</td></tr> <tr><td style="font-size: x-small;">Serial Number :</td><td style="font-size: x-small;">TW1234567</td></tr> <tr><td style="font-size: x-small;">Description :</td><td style="font-size: x-small;">TEXIO,PFR-100L50</td></tr> <tr><td style="font-size: x-small;">Firmware Version :</td><td style="font-size: x-small;">01.01.12345678</td></tr> <tr><td style="font-size: x-small;">Hostname :</td><td style="font-size: x-small;">P-1234567</td></tr> <tr><td style="font-size: x-small;">IP Address :</td><td style="font-size: x-small;">192.168.0.103</td></tr> <tr><td style="font-size: x-small;">Subnet Mask :</td><td style="font-size: x-small;">255.255.255.0</td></tr> <tr><td style="font-size: x-small;">Gateway :</td><td style="font-size: x-small;">192.168.0.1</td></tr> <tr><td style="font-size: x-small;">DNS :</td><td style="font-size: x-small;">0.0.0.0</td></tr> <tr><td style="font-size: x-small;">MAC Address :</td><td style="font-size: x-small;">00-11-22-AA-BB-02</td></tr> <tr><td style="font-size: x-small;">DHCP State :</td><td style="font-size: x-small;">ON</td></tr> <tr><td style="font-size: x-small;">VISA TCP/IP Connect String :</td><td style="font-size: x-small;">TCP/IP0::192.168.0.103::2268::SOCKET</td></tr> </table>	Manufacturer :	TEXIO	Serial Number :	TW1234567	Description :	TEXIO,PFR-100L50	Firmware Version :	01.01.12345678	Hostname :	P-1234567	IP Address :	192.168.0.103	Subnet Mask :	255.255.255.0	Gateway :	192.168.0.1	DNS :	0.0.0.0	MAC Address :	00-11-22-AA-BB-02	DHCP State :	ON	VISA TCP/IP Connect String :	TCP/IP0::192.168.0.103::2268::SOCKET
Manufacturer :	TEXIO																								
Serial Number :	TW1234567																								
Description :	TEXIO,PFR-100L50																								
Firmware Version :	01.01.12345678																								
Hostname :	P-1234567																								
IP Address :	192.168.0.103																								
Subnet Mask :	255.255.255.0																								
Gateway :	192.168.0.1																								
DNS :	0.0.0.0																								
MAC Address :	00-11-22-AA-BB-02																								
DHCP State :	ON																								
VISA TCP/IP Connect String :	TCP/IP0::192.168.0.103::2268::SOCKET																								

Copyright 2017 © TEXIO TECHNOLOGY CORPORATION All Rights Reserved.



Note

If the network connection can not be confirmed, update the power switch again or update the web browser loading.



Note

For further details, please see the programming manual.

The web browser interface allows you to access the following:

- Network configuration settings
- Measurement setting
- Normal Function setting
- Power On Configuration setting

PF-100 Series Web Control Pages [Visit Our Site](#) [Support](#) [Contact Us](#)

Network Configuration

[Welcome Page] **IP Address:** 192.168.1.100
Subnet Mask: 255.255.255.0

[Network Configuration] **Gateway:** 192.168.1.1
DNS 1: 192.168.1.2
DHCP State: ON OFF
Terminal 1:

[Measurement]

[Normal Function]

[Power On Configuration]

Copyright 2017 © TEXIO TECHNOLOGY CORPORATION All Rights Reserved.

Network configuration setting

PF-100 Series Web Control Pages [Visit Our Site](#) [Support](#) [Contact Us](#)

Normal Function

[Welcome Page] **Delay Time** s **OCP Filter**

[Network Configuration] **Output OFF** s **Measure Average**
 Low
 Middle
 High

[Measurement] **V-I mode & slew rate**
V-I mode: High speed priority
Range Voltage: V/A **Lock Mode** Mode 1
Falling Voltage: V/A **Bleeder Control**
 ON OFF

[Normal Function] **Range Current:** V/A **Buzzer**
 ON OFF

[Power On Configuration] **4.000** A/A **Falling Current:** A/A

Copyright 2017 © TEXIO TECHNOLOGY CORPORATION All Rights Reserved.

Normal Function setting

PF-100 Series Web Control Pages [Visit Our Site](#) [Support](#) [Contact Us](#)

Measurement

[Welcome Page] **26.72** V **0.0002** A
VSR CV ISR CC RMT DLY ERR ALM RUN

[Network Configuration] **Voltage** V **Current** A

[Measurement] **OVP** V **OCP** A

[Normal Function] **UVL** V **Voltage Setting Limit**
 ON OFF
Current Setting Limit
 ON OFF

[Power On Configuration]

Copyright 2017 © TEXIO TECHNOLOGY CORPORATION All Rights Reserved.

Measurement setting

PF-100 Series Web Control Pages [Visit Our Site](#) [Support](#) [Contact Us](#)

Power On Configuration

[Welcome Page] **CV Control**

[Network Configuration] **CC Control**

[Measurement] **Power-ON Output**

[Normal Function] **External Out Logic**

[Power On Configuration]

Copyright 2017 © TEXIO TECHNOLOGY CORPORATION All Rights Reserved.

Power On Configuration setting

5-3-3. Socket Server Configuration

Configuration	<p>This configuration example will configure the PFR-100 socket server.</p> <p>The following configuration settings will manually assign the PFR-100 an IP address and enable the socket server. The socket server port number is fixed at 2268.</p> <ol style="list-style-type: none">1. Connect an Ethernet cable from the network to the rear panel Ethernet port.2. Press the Function key to enter the Normal configuration settings. <p>Set the following LAN settings (setting examples from F-39 to F-54):</p> <table><tr><td>F-29 = 5</td><td>Turn LAN (Socket) on</td></tr><tr><td>F-37 = 0</td><td>Disable DHCP</td></tr><tr><td>F-39 = 192</td><td>IP Address part 1 of 4</td></tr><tr><td>F-40 = 168</td><td>IP Address part 2 of 4</td></tr><tr><td>F-41 = 5</td><td>IP Address part 3 of 4</td></tr><tr><td>F-42 = 133</td><td>IP Address part 4 of 4</td></tr><tr><td>F-43 = 255</td><td>Subnet Mask part 1 of 4</td></tr><tr><td>F-44 = 255</td><td>Subnet Mask part 2 of 4</td></tr><tr><td>F-45 = 255</td><td>Subnet Mask part 3 of 4</td></tr><tr><td>F-46 = 0</td><td>Subnet Mask part 4 of 4</td></tr><tr><td>F-47 = 192</td><td>Gateway part 1 of 4</td></tr><tr><td>F-48 = 168</td><td>Gateway part 2 of 4</td></tr><tr><td>F-49 = 5</td><td>Gateway part 3 of 4</td></tr><tr><td>F-50 = 101</td><td>Gateway part 4 of 4</td></tr><tr><td>F-51 = 192</td><td>DNS part 1 of 4</td></tr><tr><td>F-52 = 168</td><td>DNS part 2 of 4</td></tr><tr><td>F-53 = 5</td><td>DNS part 3 of 4</td></tr><tr><td>F-54 = 101</td><td>DNS part 4 of 4</td></tr></table>	F-29 = 5	Turn LAN (Socket) on	F-37 = 0	Disable DHCP	F-39 = 192	IP Address part 1 of 4	F-40 = 168	IP Address part 2 of 4	F-41 = 5	IP Address part 3 of 4	F-42 = 133	IP Address part 4 of 4	F-43 = 255	Subnet Mask part 1 of 4	F-44 = 255	Subnet Mask part 2 of 4	F-45 = 255	Subnet Mask part 3 of 4	F-46 = 0	Subnet Mask part 4 of 4	F-47 = 192	Gateway part 1 of 4	F-48 = 168	Gateway part 2 of 4	F-49 = 5	Gateway part 3 of 4	F-50 = 101	Gateway part 4 of 4	F-51 = 192	DNS part 1 of 4	F-52 = 168	DNS part 2 of 4	F-53 = 5	DNS part 3 of 4	F-54 = 101	DNS part 4 of 4
F-29 = 5	Turn LAN (Socket) on																																				
F-37 = 0	Disable DHCP																																				
F-39 = 192	IP Address part 1 of 4																																				
F-40 = 168	IP Address part 2 of 4																																				
F-41 = 5	IP Address part 3 of 4																																				
F-42 = 133	IP Address part 4 of 4																																				
F-43 = 255	Subnet Mask part 1 of 4																																				
F-44 = 255	Subnet Mask part 2 of 4																																				
F-45 = 255	Subnet Mask part 3 of 4																																				
F-46 = 0	Subnet Mask part 4 of 4																																				
F-47 = 192	Gateway part 1 of 4																																				
F-48 = 168	Gateway part 2 of 4																																				
F-49 = 5	Gateway part 3 of 4																																				
F-50 = 101	Gateway part 4 of 4																																				
F-51 = 192	DNS part 1 of 4																																				
F-52 = 168	DNS part 2 of 4																																				
F-53 = 5	DNS part 3 of 4																																				
F-54 = 101	DNS part 4 of 4																																				

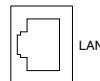

Page 48

5-3-4. Socket Server Function Check

Background	<p>To test the socket server functionality, National Instruments Measurement and Automation Explorer can be used. This program is available on the NI website, www.ni.com, via a search for the VISA Run-time Engine page, or “downloads” at the following URL, http://www.ni.com/visa/</p>
Requirements	<p>PC Operating System(OS): Windows 7 or higher</p>
Functionality check	<ol style="list-style-type: none">1. Start the NI Measurement and Automation Explorer (MAX) program. start>All PROGRAM>National Instruments>Measurement & Automation



Display and operated by a version of NI-MAX is different. Please operate in accordance with the version you are using.

2. From the Configuration panel access *My System>Devices and Interfaces>Network Devices*
3. Press *Add New Network Device>Visa TCP/IP Resource...*

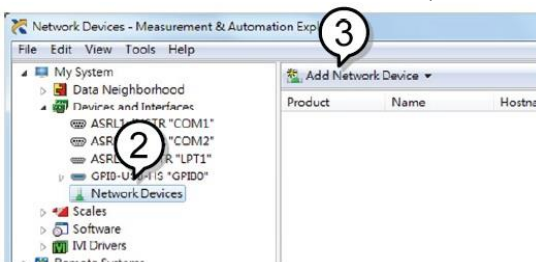

4. Select *Manual Entry of Raw Socket* from the popup window.

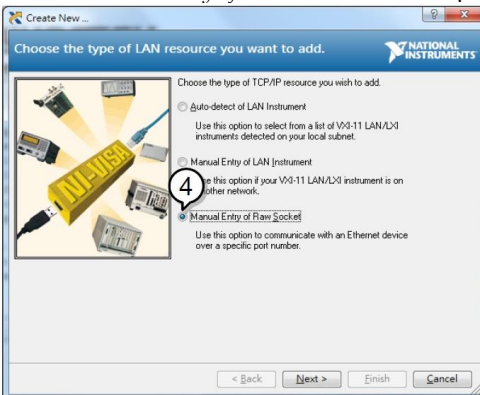

5. Enter the IP address and the port number of the PFR-100. The port number is fixed at 2268.
6. Click the *Validate* button.
7. A popup will appear if a connection is successfully established.

- Click *Next*.

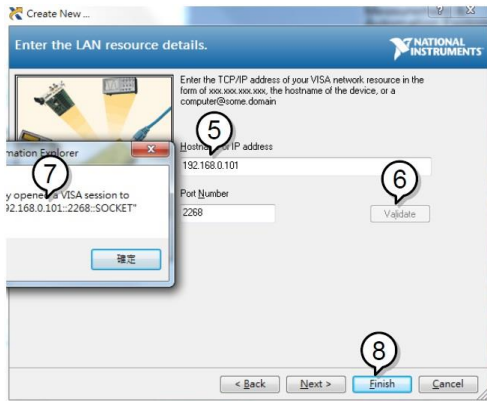

- Next configure the Alias (name) of the PFR-100 connection. Example : PFR-100_DC1
- Click *finish*.

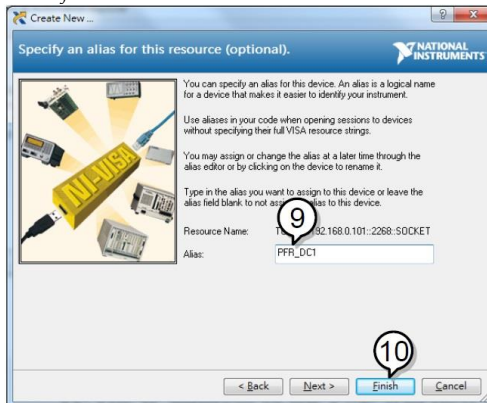

- The IP address of the PFR-100 will now appear under Network Devices in the configuration panel. Select this icon now.
- Press *Open VISA Test Panel*.

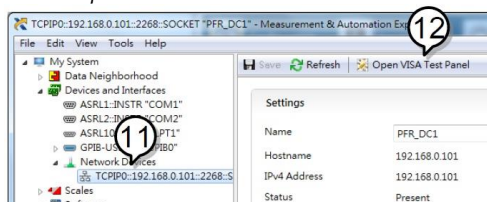

- Click the *Configuration* icon.
- Click on *I/O Settings*.
- Make sure the *Enable Termination Character* check box is checked, and the terminal character is $\backslash n$ (Value: xA).
- Click *Apply Changes*.

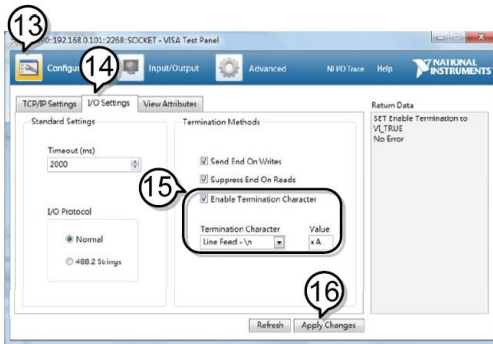

17. Click the *Input/Output* icon.
18. Enter `*IDN?` in the *Select or Enter Command* dialog box if it is not already.
19. Click the *Query* button.
20. The `*IDN?` query will return the Manufacturer, model name, serial number and firmware version in the dialog box.

TEXIO,PFR-100L50,TW1234567,01.01.12345678

Manufacturer: TEXIO
 Model name : PFR-100L50
 Serial number : TW1234567
 Firmware version : 01.01.12345678

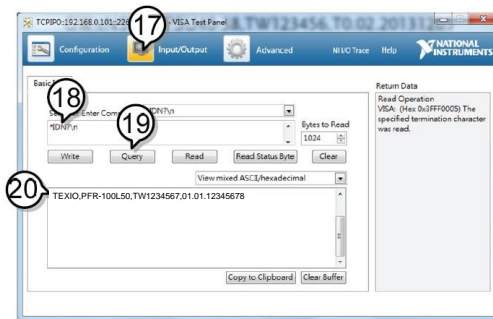

 **Note**

For further details, please see the programming manual.

5-4. Serial Interface

5-4-1. UART Remote Interface

The PFR-100 uses the IN & OUT ports for UART communication coupled with RS232 (Part number: GTL-259) or RS485 adapters (Part number: GTL-260).

When using only one unit with RS485, connect the end terminal connector to Remote-OUT. The end terminal connector is not required in RS232.

The pin outs for the adapters are shown below.

RS232 cable with DB9 & RJ-45 shielded connectors GTL-259	DB-9 Connector		Remote-IN Port		Remarks	
	Pin No.	Name	Pin No.	Name		
	Housing	Shield	Housing	Shield		
	2	RX	7	TX		Twisted pair
3	TX	8	RX			
5	SG	1	SG			
RS485 cable with DB9 & RJ-45 shielded connectors GTL-260	DB-9 Connector		Remote-IN Port		Remarks	
	Pin No.	Name	Pin No.	Pin No.		Name
	Housing	Shield	Housing	Shield		
	9	TXD-	6	RXD-		Twisted pair
	8	TXD+	3	RXD+		
	1	SG	1	SG		
5	RXD-	5	TXD-	Twisted pair		
4	RXD+	4	TXD+			

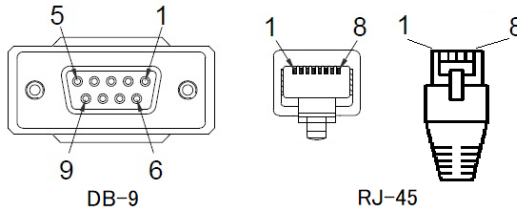

Steps

1. Connect the RS232 serial cable (GTL-259) to the Remote-IN port on the real panel. Connect the other end of the cable to the PC. When using only one unit with RS485, connect the end terminal connector to Remote-OUT.

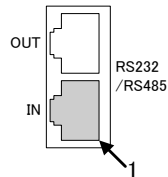

2. Press the Function key to enter the Normal configuration settings.

Page 48

Set the following UART settings:

F-29 = 1 or 2

Interface port:

1 = RS232 or 2 = RS485

F-71 = 0~7

Set the baud rate:

0 = 1200, 1 = 2400, 2 = 4800,

3 = 9600, 4 = 19200, 5 = 38400,

6 = 57600, 7 = 115200

F-72 = 0 or 1

Data bits: 0 = 7 or 1 = 8

F-73 = 0~2

Parity 0 = none, 1 = odd, 2 = even

- F-74 = 0 or 1 Stop bits:
0 = 1, 1 = 2
- F-75 = 0 TCP: 0 = SCPI
- F-76 = 0~30 UART address for multi-unit remote connection.
- F-77 = 0~3 Multi-Drop control:
0 = Disable, 1 = Master, 2 = Slave,
3 = Display Information
- F-78 = 0~30 Multi-Drop status display
Displayed parameter: AA-S
AA: 0~30 (Address),
S: 0~1 (Off-line/On-line status).

3. The RMT indicator will turn on when a remote connection has been established.

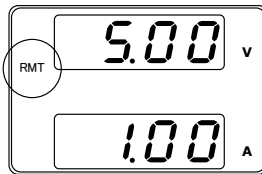

5-4-2. UART Function Check

Functionality check

Invoke a terminal application such as Realterm.
To check the COM port No, see the Device Manager in the PC.

Run this query command via the terminal application after the instrument has been configured for either RS232 or RS485 remote control.

*IDN?

This should return the Manufacturer, Model number, Serial number, and Firmware version in the following format:

TEXIO,PFR-100L50,TW1234567,01.01.12345678

Manufacturer: TEXIO
Model name : PFR-100L50
Serial number : TW1234567
Firmware version : 01.01.12345678

^j (LF:Line Feed) can be used as the terminal character when entering the queries/commands from a terminal application.



Note

For further details, please see the programming manual.

5-5. Multidrop Interface

5-5-1. Multiple Unit Connection

The PFR-100 power supplies can have up to 31 units daisy-chained together using the 8 pin connectors (Remote-IN OUT ports) on the rear panel. The first unit (master) in the chain is remotely connected to a PC using USB, GPIB or LAN (Multi-Drop mode). Each subsequent unit (slave) is daisy-chained to the next using a RS485 local bus. The Remote-OUT port on the last terminal must be terminated by the end terminal connector.

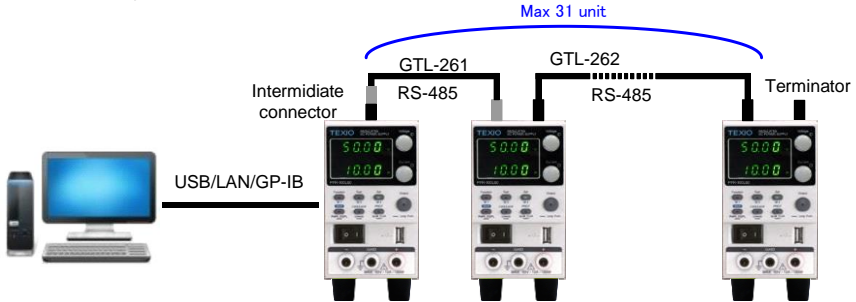

There is a mode for controlling multiple units. This mode allows the user to enter the SCPI commands developed for the instrument (Multi-Drop mode). In this mode, only the Multi-Drop parameters have to be specified. Each unit is assigned a unique address and can then be individually controlled from the host PC.

5-5-1-1. Multi-Drop mode

Operation

1. All units must be powered down before starting the Multi-Drop mode configuration.

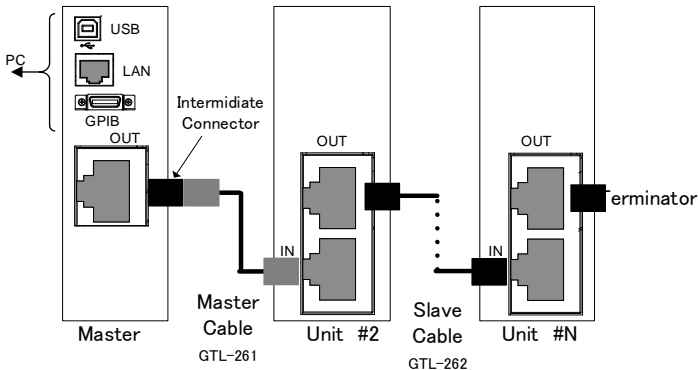

Intermediate connector



Terminator

2. Connect the first unit's LAN, USB or GPIB port to a PC.
 3. Connect the Remote-OUT port on the first unit to the IN port of the second unit using the master serial link cable (gray plug) GTL-261
 4. Connect all the remaining units between the Remote-OUT port and the IN port with the slave serial link cable (black plug) GTL-262 until all the desired units have been daisy-chained together.
 5. Terminate the Remote-OUT port of the last unit with the end terminal connector included in the GTL-261.
 6. Power up all slave units.
 7. Set the addresses of all slave units using the F-76 parameter.
 F-76 = 00~30 Set the address of the master unit. It must be a unique address identifier.
 8. Set the Multi-Drop setting parameter (F-77) to Slave for all slave units.
 F-77 = 2 Set the Multi-Drop setting to slave.
 9. Power up the master unit.
 10. Set the addresses of the master units using the F-76 parameter.
 F-76 = 00~30 Set the address of the unit. It must be a unique address identifier.
 11. You can check the slaves' addresses by using the F-77 parameter on the master unit.
 F-77 = 3 Display on each slave units the configured address. This can show if identical addresses have been assigned individually to each slave units.
 12. Set the Multi-Drop setting parameter (F-77) to Master.
 F-77 = 1 Set the Multi-Drop setting to master.
 13. You can display the status of each slave unit by using the F-78 parameter.
 F-78 = 00~30 Displayed parameter: AA-S
 AA: 0~30 (Address),
 S: 0~1 (Off-line/On-line status).
 14. Multiple units can now be operated using SCPI commands. See the programming manual or see the function check below for usage details.
-

Slave serial link cable with RJ-45 shielded connector (black plug) GTL-262	RS-485 slave serial link pin assignment			
	8 Pin Connector (IN)		8 Pin Connector (OUT)	
	Pin No.	Name	Pin No.	Name
	Housing	Shield	Housing	Shield
	1	SG	1	SG
	6	TXD-	6	TXD-
	3	TXD+	3	TXD+
Master serial link cable with RJ-45 shielded connector (gray plug) GTL-261	RS-485 master serial link pin assignment			
	8 Pin Connector (IN)		8 Pin Connector (OUT)	
	Pin No.	Name	Pin No.	Name
	Housing	Shield	Housing	Shield
	1	SG	1	SG
	6	TXD-	5	RXD-
	3	TXD+	4	RXD+
5	RXD-	6	TXD-	
4	RXD+	3	TXD+	



5-5-1-2. Multi-Drop mode Function Check

Functionality
check

Invoke a terminal application such as Realterm.
To check the COM port No, see the Device Manager in the PC.

When using the Multi-Drop mode, the entire SCPI command list developed for the PFR-100 can be used. Each unit can be individually controlled after a slave unit has been selected. For this function check, we will assume that the master unit is assigned to address 0, while a slave is assigned address 5.

Run this query command via the terminal application after the instruments have been configured for multi-unit control with Multi-Drop mode. See page 80.

```
:INST:SEL 0      ← Press ENTER after typing.  
*IDN?           ← Press ENTER after typing.  
TEXTIO,PFR-100L50,TW1234567,01.01.12345678
```

```
:INST:SEL 5      ← Press ENTER after typing.  
*IDN?           ← Press ENTER after typing.  
TEXTIO,PFR-100L50,TW7654321,01.01.12345678
```

```
:INST:SEL 6      ← Press ENTER after typing.  
Selects the unit with address 6 (not configured in our  
example). An error is displayed on the master front panel.
```

```
:SYST:ERR?      ← Press ENTER after typing.  
Settings conflict  
Query the system errors. "Settings conflict" is returned.
```

```
:INST:STAT?     ← Press ENTER after typing.  
33,0  
Returns the active units and master unit in the bus.  
33 = 0b100001  
The units at address 0 and address 5 are on-line.  
0  
Master device's address is 0.
```



Note

For further details, please see the programming manual.

6. FAQ

- **How often should the power supply be calibrated?**

The PFR-100 should be calibrated by an authorized service center at least every 2 years. For details regarding calibration, see your local dealer or our website.

- **The power supply won't let me change the mode (CVmode ↔ CCmode).**

To set the power supply to CC or CV mode, the Function key must be held when the power is turned on to enter the Power On Configuration Mode. (See page 47.)

- **The OVP voltage is triggered earlier than expected.**

When setting the OVP voltage, take into account the voltage drop from the load cables. As the OVP level is set from the output terminals and not the load terminals, the voltage at the load terminals may be slightly lower.

- **Can I combine more than 1 cable together for the output wiring?**

Yes. Cables can be used together (in parallel) if the current capacity of a single cable is insufficient. However the withstand voltage should also be taken into account. Ensure the cables are twisted together and are the same length.

- **The accuracy does not match the specification.**

Make sure the device is powered on for at least 30 minutes, within +20°C~+30°C. This is necessary to stabilize the unit to match the specification.

For more information, contact your local dealer or us.

7. APPENDIX

7-1. PFR-100 Factory Default Settings

The following default settings are the factory configuration settings for the power supply (Function settings/Test settings).

For details on how to return to the factory default settings, see page 20.

Initial Settings	Default Setting	
Output	Off	
Key Lock	0 (Disabled)	
Voltage	0 V	
Current	0 A	
OVP	Maximum	
OCP	Maximum	
UVL	0V	
Normal Function Settings	Setting	Default Setting
Output ON Delay Tme	F-01	0.00s
Output OFF Delay Time	F-02	0.00s
V-I Mode Slew Rate Select	F-03	0 = CV high speed priority
Rising Voltage Slew Rate	F-04	100.0V/s (PFR-100L50)
		500.0V/s (PFR-100M250)
Falling Voltage Slew Rate	F-05	100.0V/s (PFR-100L50)
		500.0V/s (PFR-100M250)
Rising Current Slew Rate	F-06	20.00A/s (PFR-100L50)
		4.000A/s (PFR-100M250)
Falling Current Slew Rate	F-07	20.00A/s (PFR-100L50)
		4.000A/s (PFR-100M250)
Bleeder ON/OFF Control	F-09	1 = ON
Buzzer ON/OFF Control	F-10	1 = ON
Detection Time of OCP	F-12	0.0 sec
Current Setting Limit	F-13	0 = OFF (The limit function of current setting is disabled.)
Voltage Setting Limit	F-14	0 = OFF (The limit function of voltage setting is disabled.)
Memory Recall Display	F-15	0 = OFF
Measurement Average Setting	F-17	0 = Low
Lock Mode	F-19	0 = Panel lock: allow output off
USB/GP-IB Setting	Setting	Default Setting
GP-IB Address	F-23	8
LAN Setting	Setting	Default Setting
DHCP	F-37	1 = ON
Web password active	F-60	1 = Enable
Web setting password	F-61	0000
UART Setting	Setting	Default Setting
UART Baudrate	F-71	7 = 115200
UART Data Bits	F-72	1 = 8 bits
UART Parity	F-73	0 = None
UART Stop Bit	F-74	0 = 1 bit

UART TCP	F-75	0 = SCPI
Power On Configuration Setting	Setting	Default Setting
CV Control	F-90	0= Panel control (local)
CC Control	F-91	0= Panel control (local)
Power ON Output	F-92	0 = Safe Mode (Output OFF at startup)
External Out Logic Control	F-94	0 = High ON

Data of the test script is not cleared by the initialization by F-88. Clear by deleting the test script.

The preset memory data (M1, M2, M3) is not cleared by the initialization by F-88.

The Interface Select (F-29) setting is not initialized by F-88.

The setting of UART Address (F-76) and Multi-Drop Control (F-77) is not initialized by F-88.

7-2. Error Messages & Messages

The following error messages or messages may appear on the PFR-100 screen during operation.

Error Messages	Description
OHP	Over temperature protection
SENSE ALARM1	Sense Alarm1
SENSE ALARM2	Sense Alarm2
AC	AC fail
OVP	Over voltage protection
OCP	Over current protection
OPP	Over power protection
SHUT DOWN	Force shutdown
Err 001	USB mass storage is not present
Err 002	No (such) file in USB mass storage
Err 003	Empty memory location
Err 004	File access error
Err 007	Slave occurs Off-line (Multi-Drop mode)

Nomal Messages	Description
MSG 001	External control of output. Output off (F-94=0, High=on)
MSG 002	External control of output. Output off (F-94=1, Low=on)

Communication Interface Messages	Description
MS ON	Mass storage plugged into front USB port
MS OFF	Mass storage removed from front USB port

If an error message is displayed, repair may be necessary.

7-3. LED ASCII Table Character Set

Use the following table to read the LED display messages.

0	1	2	3	4	5	6	7	8	9	A	B	C	D
0	1	2	3	4	5	6	7	8	9	A	b	C	d
E	F	G	H	I	J	K	L	M	N	O	P	Q	R
E	F	G	H	I	J	K	L	M	N	O	P	Q	R
S	T	U	V	W	X	Y	Z	()	+	-	,	
S	T	U	V	W	X	Y	Z	()	+	-	,	

7-4. Test Script Error Code

The following error code is in Test Script.

Code No.	Description
0	No error
-1 ~ -8	File format errors, control character errors, undefined words, etc.
-9 ~ -19	Number of cycles error
-20 ~ -29	Step number error
-30 ~ -39	Start / Stop error
-40 ~ -49	Mode setting error
-50 ~ -59	Time setting error
-60 ~ -69	Voltage value error
-70 ~ -79	Current value error
-80 ~ -89	OVP error
-90 ~ -99	OCP error
-100 ~ -109	Voltage slew rate error
-110 ~ -119	Current slew rate error
-120 ~ -129	IR error
-130 ~ -139	Display configuration error

8. Specification list

The specifications apply when the PFR-100 is powered on for at least 30 minutes.

8-1. Rating

8-1-1. Output

Model name	PFR-	100L50	100M250
Rated Output Voltage	V	50	250
Rated Output Current	A	10	2
Rated Output Power	W	100	100
Power ratio		5	5

8-1-2. Constant Voltage Mode

Model name	PFR-	100L50	100M250
Line Regulation (*1)	mV	8	30
Load Regulation (*2)	mV	10	33
Ripple and Noise (*3)	p-p (*4)	mV	50
	r.m.s. (*5)	mV	4
Temperature coefficient (after a 30 minute warm-up)	ppm/°C	100	100
Remote sense compensation voltage (single wire)	V	1	1
Rise time (*6)	Rated load	ms	50
	No load	ms	50
Fall time (*7)	Rated load	ms	100
	No load	ms	500
Transient response time (*8)	ms	1.5	2

8-1-3. Constant Current Mode

Model name	PFR-	100L50	100M250
Line Regulation (*1)	mA	8	1.2
Load Regulation (*9)	mA	10	3.2
Ripple and Noise	r.m.s.	mA	10
Temperature coefficient (after a 30 minute warm-up)	ppm/°C	200	200

8-1-4. Protection Function

Model name		PFR-	100L50	100M250
Over voltage protection (OVP)	Setting range	V	5 - 55	5 - 275
	Setting accuracy	V	0.50	2.5
Over current protection (OCP)	Setting range	A	1 - 11	0.2 - 2.2
	Setting accuracy	A	0.20	0.040
Under voltage limit (UVL)	Setting range	V	0 - 52.5	0 - 262.5
Over temperature protection (OHP)	Operation	Turn the output off.(Typ.>90°C)		
Low AC input protection (AC-FAIL)	Operation	Turn the output off.(Typ.<80V)		
Shutdown (SD)	Operation	Turn the output off.		
Over Power protection (OPP)	Operation Value (fixed)	Turn the output off. Over 103% of rated output power.		
SENSE ALARM1	Vo - Vsense	V	>1.5	>2.5
SENSE ALARM2	Vo - Vsense	V	< 1.0	<1.0

8-1-5. Analog Programming and Monitoring

Model name		PFR-	100L50	100M250
External voltage control output voltage	Accuracy	V	0.50	2.50
External voltage control output current	Accuracy	mA	100	20
External resistor control output voltage	Accuracy	V	1.00	5.00
External resistor control output current	Accuracy	mA	200	40
Output voltage monitor	Accuracy	V	0.10	0.10
Output current monitor	Accuracy	V	0.10	0.10
Shutdown control	Turns the output off with a LOW (0V to 0.5V) or short-circuit.			
Output on/off control	Possible logic selections: Turn the output on using a LOW (0V to 0.5V) or short-circuit, turn the output off using a HIGH (4.5V to 5V) or open-circuit. Turn the output on using a HIGH (4.5V to 5V) or open-circuit, turn the output off using a LOW (0V to 0.5V) or short-circuit.			
Alarm clear control	Clear alarms with a LOW (0V to 0.5V) or short-circuit.			
CV/CC/ALM/PWR OFF /OUT ON indicator	Photocoupler open collector output; Maximum voltage 30V, maximum sink current 8mA.			

8-1-6. Front Panel

Model name	PFR-	100L50	100M250		
Output voltage setting range	V	0 - 52.5	0 - 262.5		
Output voltage resolution	mV	10	100		
Output current setting range	A	0 - 10.5	0 - 2.1		
Output current resolution	mA	10	1		
Display, 4 digits	Volatge accuracy	0.1% of reading +	mV	40	200
	Current accuracy	0.2% of reading +	mA	20	2
Indications	GREEN LED's: CV, CC, VSR, ISR, DLY, RMT, LAN, M1, M2, M3, RUN, W, V, A, Output ON RED LED's: ALM, ERR				
Buttons	Function(M1), Test(M2), Set(M3), Shift(PWR_DSPL), Lock/Local(Unlock), PROT(ARM_CLR), Output				
Knobs	Voltage, Current				
USB port	Type A USB connector				
Binding Post	RED: Positive output, BLACK: Negative output, GREEN: Earth ground				

8-1-7. Programming and Measurement (Control)

Model name	PFR-	100L50	100M250	
Output voltage programming accuracy	0.1% of setting +	mV	40	200
Output current programming accuracy	0.2% of setting +	mA	20	2
Output voltage programming resolution		mV	2	10
Output current programming resolution		mA	1	0.1
Output voltage measurement accuracy	0.1% of reading +	mV	40	200
Output current measurement accuracy	0.2% of reading +	mA	20	2
Output voltage measurement resolution		mV	2	10
Output current measurement resolution		mA	1	0.1

8-1-8. Input Characteristics

Model name	PFR-	100L50	100M250
Rated Input		100V AC~240V AC	±10%, 50Hz~60Hz,Single phase
Input voltage range	Vac		85 - 265
Input frequency range	Hz		47 - 63
Maximum input current	100Vac	A	1.5
	200Vac	A	0.75
Inrush current		Less than 20A	
Maximum input power	VA	150	150
Power factor	100Vac		0.98
	200Vac		0.95
Efficiency	100Vac	%	70
	200Vac	%	72
Hold-up time		20ms or greater	

8-1-9. Interface Capabilities

Model name	PFR-	100L50	100M250
USB		USB 1.1 compliant full speed	
		Select Host (front a connector) or Slave (rear B connector)	
		Device class at Slave: Select USB-CDC	
RS-232/RS-485		Complies with the RS-232C/RS-485 specifications (excluding the connector)	
LAN (Factory Optional)		MAC Address, DHCP, DNS IP Address, User Password, Gateway IP Address, Instrument IP Address, Subnet Mask Auto-MDIX	
GPIB (Factory Optional)		SCPI-1993, IEEE 488.2 compliant interface	

8-1-10. Environment Conditions

Model name	PFR-	100L50	100M250
Operating temperature		0°C to 40°C	
Storage temperature		-20°C to 70°C	
Operating humidity		20% to 80% RH; No condensation	
Storage humidity		20% to 85% RH; No condensation	
Altitude		Maximum 2000m	
Environment		Indoor , Over voltage category II	

8-1-11. General Specifications

Model name	PFR-	100L50	100M250
Weight	main unit only	Approx. 2.5kg	
Dimensions	(W×H×D)	mm	71×124×301
Cooling	Natural convection cooling.		
EMC	Complies with the European EMC directive 2014/30/EU for Class A test and measurement products. EN61326-1(Class A)		
Safety	Complies with the European Low Voltage directive 2014/35/EU and carries the CE-marking. EN61010-1(Class 1,Pollution Degree 2)		
Withstand voltage	Between input and chassis	No abnormalities at 1500 Vac for 1 minute.	
	Between input and output	No abnormalities at 3000 Vac for 1 minute.	
	Between output and chassis	No abnormalities at 500 Vdc for 1 minute.	
Insulation resistance	Between input and chassis	500 Vdc, 100MΩ or more	
	Between input and output	500 Vdc, 100MΩ or more	
	Between output and chassis	500 Vdc, 100MΩ or more	

Notes:

- (*1) At 85 ~ 132Vac or 170 ~ 265Vac, constant load.
- (*2) From No-load to Full-load, constant input voltage. Measured at the sensing point in Remote Sense.
- (*3) Measure with JEITA RC-9131B (1:1) probe
- (*4) Measurement frequency bandwidth is 10Hz to 20MHz.
- (*5) Measurement frequency bandwidth is 5Hz to 1MHz.
- (*6) From 10% to 90% of rated output voltage, with rated resistive load.
- (*7) From 90% to 10% of rated output voltage, with rated resistive load.
- (*8) Time for output voltage to recover within 0.1% + 10mV of its rated output for a load change from 50 to 100% of its rated output current.
- (*9) For load voltage change, equal to the unit voltage rating, constant input voltage.

8-2. PFR-100 Dimensions

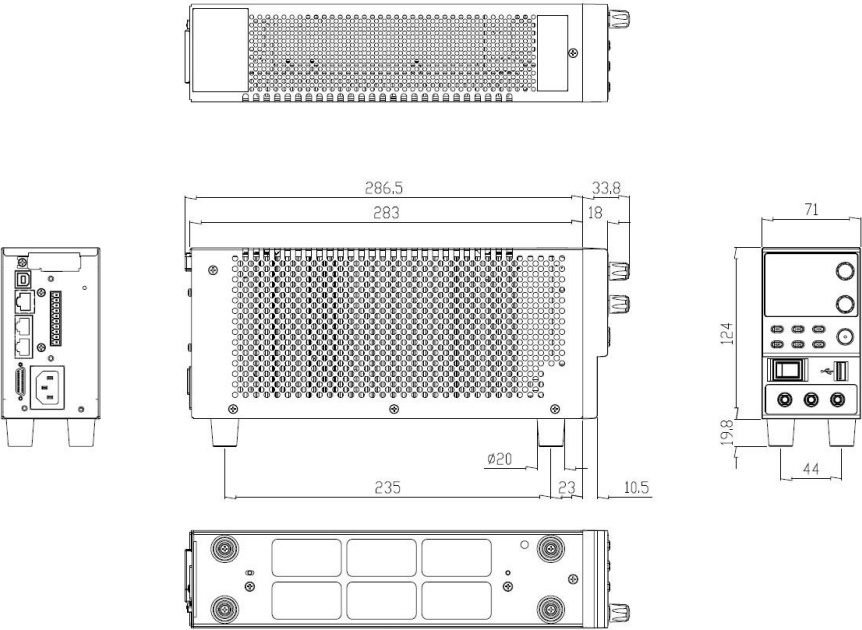



TEXIO TECHNOLOGY CORPORATION

7F Towa Fudosan Shin Yokohama Bldg.
2-18-13, Shin Yokohama, Kohoku-ku, Yokohama, Kanagawa, 222-0033 Japan
<https://www.texio.co.jp/>

