

# INSTRUCTION MANUAL

## ELECTRONIC LOAD

### LSG SERIES

**LSG-175**

**LSG-175H**

**LSG-350**

**LSG-350H**

**LSG-1050**

**LSG-1050H**

**LSG-2100S**

**LSG-2100SH**



# CONTENTS

USING THE PRODUCT SAFELY .....	I -IV
<b>1. GETTING STARTED.....</b>	<b>1</b>
1-1. LSG Series Introduction .....	1
1-1-1. Model Line Up.....	1
1-1-2. Main Features.....	2
1-2. Accessories .....	3
1-2-1. Accessories .....	3
1-2-2. Package Contents .....	4
1-3. Appearance.....	5
1-3-1. Front Panel .....	5
1-3-2. Rear Panel.....	9
1-3-3. Display.....	12
1-4. First Time Use Instructions .....	13
1-4-1. Rack Mount Kits.....	13
1-4-2. Power Up and Self-Test.....	14
1-4-3. Load Default Settings.....	14
1-4-4. Setting the Date and Time .....	15
1-4-5. Load Wiring.....	16
1-4-6. Load Wire Connections.....	18
1-4-7. Using the Front Panel Input Terminals.....	19
1-4-8. Using the Rear Panel Input Terminals .....	20
1-4-9. Using the Terminal Cover (PEL -011).....	21
1-4-10. Using the Terminal Cover (PEL -013).....	23
1-4-11. Using the Terminal Cover .....	24
1-4-12. Using the Monitor out Cover .....	24
1-4-13. Remote Sense .....	25
1-4-14. Firmware Update .....	26
1-4-15. Conventions.....	27
1-4-16. Help Menu .....	32
<b>2. OPERATION .....</b>	<b>33</b>
2-1. Basic Operation .....	33
2-1-1. CC Mode.....	33
2-1-2. CR Mode.....	35
2-1-3. CR Units .....	36
2-1-4. CV Mode.....	37
2-1-5. CP Mode.....	38
2-1-6. +CV Mode.....	39
2-1-7. Turning on the Load.....	40
2-1-8. Shorting the Load .....	41
2-1-9. Safety Short.....	42
2-1-10. Short Key Configuration.....	42
2-1-11. Short Function Enable/Disable .....	42
2-1-12. Locking the Front Panel Controls.....	43
2-2. Basic Configuration .....	44

2-2-1. Select the Switching Function.....	44
2-2-2. Select the Display Units for Dynamic Mode Levels.....	47
2-2-3. Select the Switching Time Configuration for Dynamic Mode .....	48
2-2-4. Slew Rate .....	49
2-2-5. CV, +CV Mode Response Speed .....	50
2-2-6. CC, CR and CP Mode Response Speed .....	51
2-3. Advanced Configuration Settings .....	52
2-3-1. Soft Start Setting.....	52
2-3-2. Von Voltage Settings .....	53
2-3-2-1. Von Voltage Level .....	53
2-3-2-2. Von Voltage Delay.....	53
2-3-2-3. Von Voltage Latch .....	54
2-3-3. Timer Functions .....	55
2-3-3-1. Count Time.....	55
2-3-3-2. Cut Off Time .....	55
2-3-4. Auto Load Configuration .....	56
2-3-5. Load Off (Mode) and Load Off (Range) .....	56
2-4. Step Resolution Configuration .....	57
2-4-1. Cursor Mode Configuration.....	57
2-4-2. Step Mode Configuration .....	58
2-5. Protection Settings .....	59
2-5-1. OCP .....	59
2-5-2. OPP .....	60
2-5-3. UVP .....	61
2-5-4. UVP Ring Time .....	62
2-5-5. OVP .....	63
2-5-6. UnReg.....	64
2-5-7. Para .....	64
2-5-8. RVP .....	65
2-6. System Settings .....	66
2-6-1. Input control settings.....	66
2-6-2. Sound Settings .....	66
2-6-2-1. Speaker Settings .....	66
2-6-2-2. Alarm Tone Settings .....	67
2-6-3. Display Settings .....	67
2-6-4. Language Settings.....	67
2-6-5. Input / Output Trigger Settings.....	67
2-6-5-1. Trigger in Delay .....	67
2-6-5-2. Trigger Out Width .....	68
2-6-6. Measure Average .....	68
2-6-7. VP Load Off .....	68
2-7. Go-NoGo .....	69
2-7-1. Setting the Go-NoGo Limits .....	69
2-7-2. Running a Go-NoGo Test .....	70
2-8. Save / Recall .....	71
2-8-1. File Structure .....	71
2-8-2. File Types .....	72

2-8-3. Saving Files to Internal Memory .....	73
2-8-4. Saving Files to USB Memory .....	74
2-8-5. Recalling Files from Internal Memory.....	75
2-8-6. Recalling Files from USB Memory .....	76
2-8-7. Recall Memory Safety Setting.....	78
2-8-8. File Utility .....	78
2-8-9. Preset .....	79
2-8-9-1. Quick Preset Save .....	79
2-8-9-2. Quick Preset Recall .....	79
2-8-10. Default Settings .....	80
2-8-10-1. Factory Default Settings .....	80
2-8-10-2. User's Default Setting .....	80
<b>3. Function MENU .....</b>	<b>81</b>
3-1. Function Menu Overview .....	81
3-1-1. Select a Function .....	81
3-1-2. Turning on the Load with the Selected Function.....	82
3-1-3. Complete Ring Time .....	83
3-1-4. NSEQ Timer .....	84
3-2. Program function.....	85
3-2-1. Program function Overview.....	85
3-2-2. Create a Program .....	87
3-2-3. Create a Program Chain .....	89
3-2-4. Running the Program function .....	90
3-3. Sequence function .....	91
3-3-1. Normal Sequence function Overview.....	91
3-3-2. Timing Edit Configuration.....	95
3-3-3. Data Edit Configuration.....	96
3-3-4. Running a Normal Sequence function .....	97
3-3-5. Fast Sequence function Overview .....	98
3-3-6. Timing Edit Configuration.....	102
3-3-7. Data Edit Configuration.....	103
3-3-8. Running a Fast Sequence function.....	105
3-4. OCP Test function .....	106
3-4-1. OCP Test function setting parameters .....	107
3-4-2. OCP Test function setting .....	108
3-4-3. Running a OCP Test function .....	109
3-4-4. Results of OCP Test function.....	110
3-5. OPP Test function .....	113
3-5-1. OPP Test function setting parameters .....	114
3-5-2. OPP Test function setting .....	115
3-5-3. Running a OPP Test function .....	116
3-5-4. Results of OPP Test function.....	117
3-6. BATT Test function .....	120
3-6-1. BATT Test function setting parameters.....	122
3-6-2. BATT Test function setting.....	123
3-6-3. Running a BATT Test function.....	124
3-6-4. Results of BATT Test function .....	124

3-6-5. Save the Data for BATT Test function .....	126
3-7. MPPT .....	127
3-7-1. Edit Tracking of MPPT function .....	130
3-7-2. Auto Load of MPPT function .....	131
3-7-3. Data file of test result .....	135
4. EXTERNAL CONTROL .....	138
4-1. Analog Control .....	138
4-1-1. The ports J1 /J3 Overview .....	138
4-1-1-1. The frame control ports J1 .....	138
4-1-1-2. The ports J3.....	139
4-1-2. External Voltage Control - Overview .....	140
4-1-3. External Voltage Control – Operation .....	141
4-1-4. Adjust offset and full scale with variable resistor.....	143
4-1-5. External Resistance Control - Overview .....	144
4-1-6. External Resistance Control – Operation.....	145
4-1-7. Adjust offset and full scale with variable resistor.....	147
4-1-8. Turning the Load On using External Control.....	148
4-1-9. Load On/Off Status .....	149
4-1-10. External Control of the Range.....	149
4-1-11. I Range Status .....	150
4-1-12. External Trigger Signal .....	150
4-1-13. External Alarm input.....	151
4-1-14. Alarm Status .....	151
4-1-15. Short Control.....	152
4-1-16. Monitor Signal Output .....	153
4-1-16-1. Trigger Signal Output .....	153
4-1-16-2. Current Monitor Output.....	153
4-1-16-3. Voltage Monitor Output.....	154
4-2. Parallel Operation .....	155
4-2-1. Capacity of DC electronic loads.....	155
4-2-2. Connection.....	156
4-2-3. Configuration .....	157
4-2-4. Turning the Load On.....	158
4-2-5. Disable Parallel operation .....	159
4-2-6. Connection using option plate.....	159
5. REMOTE CONTROL .....	160
5-1. Interface Configuration .....	160
5-1-1. Configure to USB Remote Interface.....	160
5-1-2. Configure RS-232C.....	160
5-1-3. Configure GP-IB Interface.....	161
5-1-4. Configure LAN Interface .....	162
5-1-5. RS-232C/USB Remote Control Function Check.....	163
5-1-6. Using RealTerm to Establish a Remote Connection.....	163
5-1-7. GP-IB Function Check .....	166
5-1-8. LAN Function Check (HTTP) .....	167
5-1-9. LAN Function Check(Socket).....	168
6. FAQ .....	171

7. APPENDIX .....	172
7-1. Replacing the Dust Filter .....	172
7-2. GP-IB/LAN Installation .....	173
7-3. Default Settings .....	174
7-4. Frame Control Connector Contacts .....	176
7-5. Operating Mode Description .....	181
7-5-1. CC Mode.....	181
7-5-2. CR Mode.....	182
7-5-3. CP Mode.....	183
7-5-4. CV Mode.....	184
7-6. LSG Operating Area .....	184
7-6-1. LSG-175 .....	184
7-6-2. LSG-350 .....	185
7-6-3. LSG-1050 .....	186
7-6-4. LSG-2100S.....	187
7-7. LSG-H Operating Area .....	188
7-7-1. LSG-175H.....	188
7-7-2. LSG-350H.....	189
7-7-3. LSG-1050H.....	190
7-7-4. LSG-2100H.....	191
7-8. LSG Series Specifications .....	192
7-8-1. Rating .....	192
7-8-2. Rating(LSG-2100S) .....	192
7-8-3. CC Mode.....	192
7-8-4. CR Mode.....	193
7-8-5. CV Mode.....	194
7-8-6. CP Mode.....	194
7-8-7. Slew Rate .....	195
7-8-8. Meter.....	195
7-8-9. Dynamic Mode .....	196
7-8-10. Soft Start.....	198
7-8-11. Remote Sensing .....	198
7-8-12. Protection Function.....	198
7-9. LSG-H Series Specifications.....	200
7-9-1. Rating (Master) .....	200
7-9-2. Rating (Booster).....	200
7-9-3. CC Mode.....	201
7-9-4. CR Mode.....	202
7-9-5. CV Mode.....	203
7-9-6. CP Mode.....	203
7-9-7. Slew Rate .....	204
7-9-8. Meter.....	205
7-9-9. Dynamic Mode .....	205
7-9-10. Soft Start.....	208
7-9-11. Remote Sensing .....	208
7-9-12. Protection Function.....	208

7-10. LSG/LSG-H Specifications .....	209
7-10-1. Sequence.....	209
7-10-2. Other.....	209
7-10-3. Analog External Control .....	210
7-10-4. Front Panel BNC Connector .....	211
7-10-5. General.....	211
7-11. Dimensions .....	213
7-11-1. LSG-175/ LSG-175H/ LSG-350/ LSG-350H .....	213
7-11-2. LSG-1050 / LSG-1050H.....	214
7-11-3. LSG-2100S/SH .....	214

The latest version of the instruction manual is posted on our website (<https://www.texio.co.jp/download/>).

In order to be environmentally friendly and reduce waste, we are gradually discontinuing the use of paper or CD manuals that come with our products. Even if there is a description in the instruction manual that the product is included, it may not be included.

■The corresponding firmware versions in this manual are as follows.

- LSG Series : Ver1.32 or higher
- LSG-H Series : Ver1.08 or higher





# USING THE PRODUCT SAFELY

## ■ Preface

To use the product safely, read this instruction manual to the end. Before using this product, understand how to correctly use it.



If you read this manual but you do not understand how to use it, ask us or your local dealer. After you read this manual, save it so that you can read it anytime as required.

## ■ Notes on reading this instruction manual

- ◆ The contents of this instruction manual include technical terms in part of their explanation. If you do not understand those terms, do not hesitate to ask us or your local dealer.

## ■ Pictorial indication and warning character indication

This instruction manual and product show the warning and caution items required to safely use the product. The following pictorial indication and warning character indication are provided.

<p>&lt;Pictorial indication&gt;</p> 	<p>Some part of this product or the instruction manual may show This pictorial indication. In this case, if the product is incorrectly used in that part, a serious danger may be brought about on the user's body or the product. To use the part with this pictorial indication, be sure to refer to this instruction manual.</p>
<p>&lt;Warning character Indication&gt;</p>  <p><b>WARNING</b></p>  <p><b>CAUTION</b></p>	<p>If you use the product, ignoring this indication, you may get killed or seriously injured. This indication shows that the warning item to avoid the danger is provided.</p> <p>If you incorrectly use the product, ignoring this indication, you may get slightly injured or the product may be damaged. This indication shows that the caution item to avoid the danger is provided.</p>

---

---

## USING THE PRODUCT SAFELY

---

---



### WARNING

#### ■ Do not remove the product's covers and panels

Never remove the product's covers and panels for any purpose. Otherwise, the user's electric shock or a fire may be incurred.

#### ■ Warning on using the product

The warning items given below are to avoid danger to the user's body and life and avoid the damage and deterioration of the product.

Use the product, observing the following warning and caution items.

#### ■ Warning items on power supply

- Power supply voltage

As the rated power supply voltage of the product, the range from 100 to 240 VAC can be used without being switched.

- Power cord

**Important: The attached power cord set can be used for this device only.**

- Protection fuse

If an input protection fuse is blown, the product does not operate. When the fuse is blown, the user can replace it. However, replace it correctly, observing the warning and caution items that are provided in the section of the instruction manual where the fuse replacement is explained. If the fuse is incorrectly replaced, a fire may occur.

- Changing the power supply voltage

The rated power supply voltage cannot be changed. Use the product only at the rated power supply voltage indicated on the product. Otherwise, a fire may occur. The product's rated power supply voltage is from 100 to 240 VAC. Use the product in this range. (For use at a voltage higher than 125 VAC, Please confirm the voltage ratings of the power cord.)

#### ■ Warning item on grounding

The product has the GND terminal on the panel surface to protect the user from electric shock and protect the product. Be sure to ground the product to safely use it.

---

---

## USING THE PRODUCT SAFELY

---

---



### WARNING

#### ■ Warning item on installation environment

- Operating temperature  
Use the product within the operating temperature indicated in the rating column. If the product is used with the vents of the product blocked or in high ambient temperatures, a fire may occur.
- Operating humidity  
Use the product within the operating humidity indicated in the rating column. Watch out for condensation by a sharp humidity change such as transfer to a room with a different humidity. Also, do not operate the product with wet hands. Otherwise, an electric shock or fire may occur.
- Use in a gas  
Use in and around a place where an inflammable or explosive gas or steam is generated or stored may result in an explosion and fire. Do not operate the product in such an environment.  
Also, use in and around a place where a corrosive gas is generated or spreading causes a serious damage to the product. Do not use the product in such an environment.
- Do not let foreign matter in  
Do not insert metal and flammable materials into the product from its vent and spill water on it. Otherwise, an electric shock and fire may occur.

#### ■ Warning item on abnormality while in use

If smoke or fire is generated from the product while in use, stop using the product, turn off the switch, and remove the power cord plug from the outlet. After confirming that no other devices catch fire, call the company or each sales office.

#### ■ Front Panel

Please do not lift up the product, while touching the front grille.

---

---

## USING THE PRODUCT SAFELY

---

---



### CAUTION

#### ■ Input/output terminal

Maximum input to the input terminals is specified to prevent the product from being damaged. Do not supply input, exceeding the specifications that are indicated in the "Rating" or "Caution on use" column in the instruction manual of the product. Otherwise, a product failure is caused. Also, do not supply power to the output terminals from the outside. Otherwise, a product failure is caused.

#### ■ When the product is left unused for a long time

Be sure to remove the power plug from the outlet.

---

---

#### (Calibration)

Although the performance and specifications of the product are checked under strict quality control during shipment from the factory, they may aging rate because of aging rate in its parts. It is recommended to periodically calibrate the product so that it is used with its performance and specifications stable. For consultation about the product calibration, call the dealer or the company or each sales office where you bought the product.

#### (Daily maintenance)

When you clean off the dirt of the product covers, panels, and knobs, avoid solvents such as thinner and benzene. Otherwise, paint may peel off or the resin surface may be affected.

To wipe off the covers, panels, and knobs, use a soft cloth with neutral detergent in it. During cleaning, be careful that water, detergents, and other foreign matters do not get into the product.

If a liquid or metal gets into the product, an electric shock and fire are caused. During cleaning, remove the power cord plug from the outlet.

---

---

Use the product correctly and safely, observing the above warning and caution items. Because the instruction manual indicates caution items even in individual items, observe those caution items to correctly use the product.

If you have questions or comments about the content of the instruction manual, ask us or E-Mail us.

# 1. GETTING STARTED

This chapter provides a brief overview of the LSG Series, the package contents, instructions for first time use and an introduction to the front panel, rear panel and GUI.



## 1-1. LSG Series Introduction

The LSG Series is a family of high-performance DC electronic loads positioned to test a wide range of different power sources. The DC electronic loads are fully programmable to simulate anything from basic static loads to complex dynamic loads. With the ability to operate independently or in parallel, the LSG Series is extremely robust and capable of molding to any test environment.

Please note that throughout this manual the term “LSG Series” refers to any one of the models in the series lineup, unless specifically stated otherwise.

### 1-1-1. Model Line Up

There are a total of 3 DC electronic load models and 1 booster pack model.

Model	Operating Voltage (DC)	Current	Power
LSG-175	1.5V~150V	35A	175W
LSG-350	1.5V~150V	70A	350W
LSG-1050	1.5V~150V	210A	1050W
LSG-175H	5V~800V	8.75A	175W
LSG-350H	5V~800V	17.5A	350W
LSG-1050H	5V~800V	52.5A	1050W

Booster Model	Operating Voltage (DC)	Current	Power
LSG-2100S	1.5V~150V	420A	2100W
LSG-2100SH	5V~800V	105A	2100W

## 1-1-2. Main Features



---

Performance	High resolution – 16 bit High capacity when used in parallel / booster:  5250W, 262.5A (LSG-1050H x 5) 9450W, 472.5A (LSG-1050H + LSG-2100SH x 4)  5250W, 1050A (LSG-1050 x 5)/ 9450W, 1890A (LSG-1050 + LSG-2100S x 4)
Features	7 operating modes: CC, CV, CR, CP, CC+CV, CR+CV, CP+CV Independent and parallel operation Fully programmable with normal and fast sequences Soft start Dynamic mode OCP, OVP and other protection features Remote sense Integrated meter Rack-mountable
Interface	USB, RS-232C, GP-IB, LAN External voltage or resistance control Front panel trigger out BNC Front panel voltage/current monitoring BNC Rear panel voltage/current monitoring Analog external control

---

## 1-2. Accessories

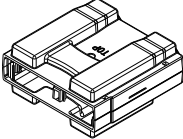
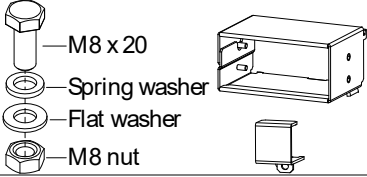
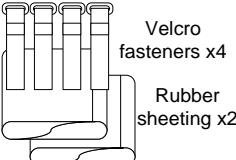
### 1-2-1. Accessories

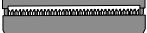
Standard Accessories	Part number	Description
	Region dependent	Power cord
	PEL-011	Load input terminal Cover x1 M3 Screw x1
		 M3 screw
	PEL-012	Terminal fittings: 2 sets of bolts/ nuts /springs /washers (type: M8) Terminal cover x2(Either one)
		 M8 x 20 Spring washer Flat washer M8 nut
	61SF-062104N1	Front terminal washers. (M6) x2
	PEL-013 (LSG-2100S/SH only)	Flexible terminal cover: Velcro fasteners x4 Rubber sheeting x2
		
	PEL-014	Frame control connector with strain relief x2.
		 Strain relief
		 Connector
	GTL-255 (LSG-2100S/SH)	Frame Link Cable

Optional Accessories	Part number	Description
	GRA-413E	Rack mount bracket for booster LSG-2100SH for EIA
	GRA-413J	Rack mount bracket for booster LSG-2100SH for JIS
	GRA-414-E	Rack mount frame for LSG-175H, LSG-350H, LSG-1050H /EIA
	GRA-414-J	Rack mount frame for LSG-175H, LSG-350H, LSG-1050H /JIS
	GTL-248	GP-IB cable, 2.0m
	GTL-246	USB cable, Type A - Type B
	PEL-010	Dust Filter
	PEL-004	GPIB option
	PEL-018	LAN option

Options	Part number	Description
	PEL-005	Connect Cu Plate
	PEL-006	Connect Cu Plate
	PEL-007	Connect Cu Plate
	PEL-008	Connect Cu Plate
	PEL-009	Connect Cu Plate

## 1-2-2. Package Contents

Check the contents before using the instrument.

Opening the box

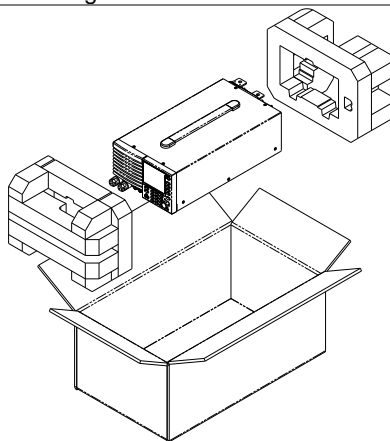

Contents (single unit)	Main unit Terminal fittings	Power cord x1 (region dependent)
------------------------	--------------------------------	-------------------------------------



### 1-3. Appearance

#### 1-3-1. Front Panel

##### LSG-175/LSG-175H / LSG-350/LSG-350H

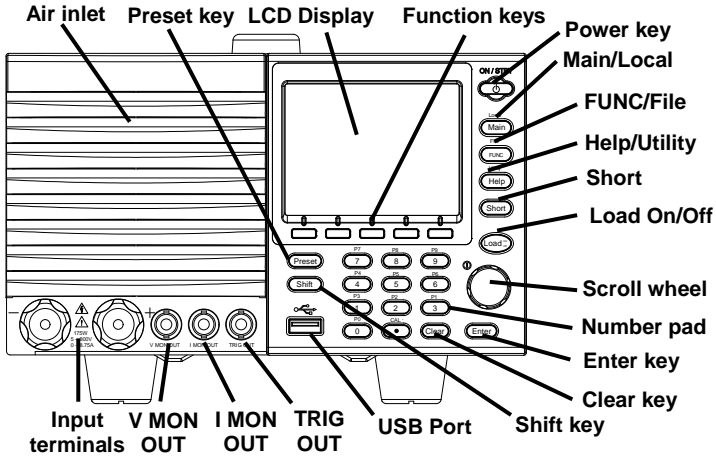



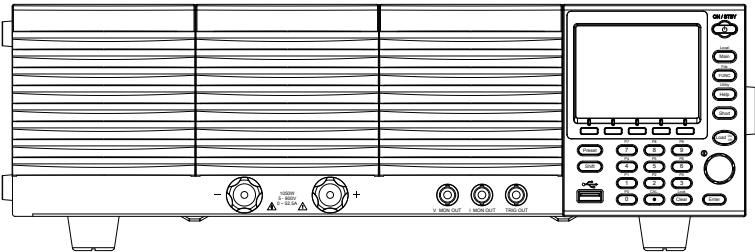



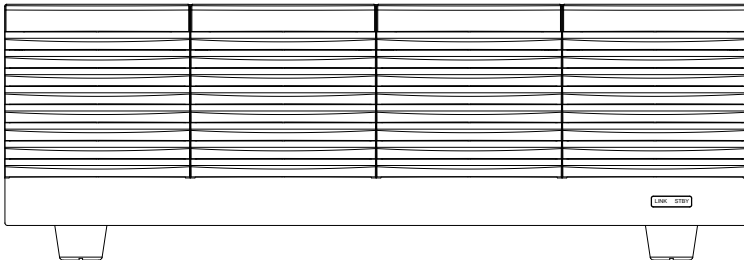





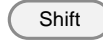

##### LSG-1050/LSG-1050H



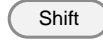

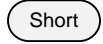

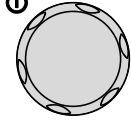











































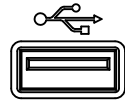
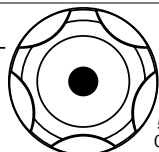

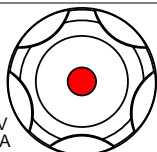
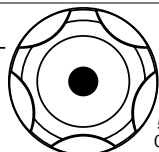
##### LSG-2100S/SH Booster Pack

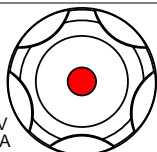
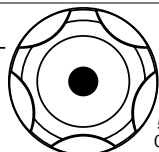

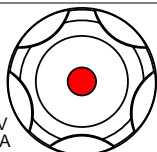
Name explanation

Air Inlet (Front grille)	The air inlet has a removable dust filter. Please do not lift up the product, while touching the front grille.	
LCD display	3.5-inch LCD display	
Function keys		The function keys directly correspond to the soft menus at the bottom of the display.
ON/STBY	<p data-bbox="361 405 479 429"><b>ON / STBY</b></p> 	Turns the unit on or puts the unit into standby mode. Use the power switch on the rear panel to turn the unit off.
Main/Local	  > 	<p data-bbox="568 517 953 569">Main: Sets the operating mode: CC, CV, CR, CP mode.</p> <p data-bbox="568 569 975 676">Local (Shift &gt; Main): Puts the instrument back into local mode from remote mode.</p>
FUNC/File	  > 	<p data-bbox="568 687 936 764">FUNC: Sets the program function, sequence function or other special functions.</p> <p data-bbox="568 764 936 818">File (Shift &gt; FUNC): Accesses the file system.</p>
Help/Utility	  > 	<p data-bbox="568 847 813 900">Help: Access the help menu.</p> <p data-bbox="568 900 963 956">Utility (Shift &gt; Help): Access the utility menu.</p>
Short		Pressing the Short key will simulate shorting the input terminals. The Short key will be lit when active.
Load on/off		Turns the load on or off. The Load On/Off key will be lit when active.
Scroll wheel		Use the scroll wheel to navigate the menu system. Pushing the scroll wheel will toggle between coarse and fine adjustment, or Select digit.
Enter		Press the Enter key to select highlighted menu items.

Clear/Lock	 	<p>Clear: Clears the current parameter values.</p> <p>Lock (Shift + Clear): Locks the front panel keys and selector knob.</p>															
Number pad	<table border="0"> <tr> <td>P7 </td> <td>P8 </td> <td>P9 </td> </tr> <tr> <td>P4 </td> <td>P5 </td> <td>P6 </td> </tr> <tr> <td>P1 </td> <td>P2 </td> <td>P3 </td> </tr> <tr> <td>P0 </td> <td>CAL. </td> <td>Lock </td> </tr> </table>	P7 	P8 	P9 	P4 	P5 	P6 	P1 	P2 	P3 	P0 	CAL. 	Lock 	<p>Number pad: Used to enter numerical values.</p> <p>P0~P9 (Preset + Number keys): Loads one of 10 preset settings.</p>			
P7 	P8 	P9 															
P4 	P5 	P6 															
P1 	P2 	P3 															
P0 	CAL. 	Lock 															
Shift		<p>Shift: Used in conjunction with other keys to select secondary functions.</p>															
Preset		<p>Used in conjunction with the number pad to save or load preset settings P0 to P9.</p>															
USB Port		<p>USB A port. Used for save and recall functions.</p>															
Front panel input terminals	<table border="0"> <tr> <td style="text-align: center;">-</td> <td style="text-align: center;">  </td> <td style="text-align: center;">  </td> <td style="text-align: center;">  </td> <td style="text-align: center;">+</td> </tr> <tr> <td></td> <td></td> <td style="text-align: center;"> <p>175W 5 - 800V 0 - 8.75A</p> </td> <td></td> <td></td> </tr> <tr> <td></td> <td style="text-align: center;">Negative terminal.</td> <td></td> <td style="text-align: center;">Positive terminal.</td> <td></td> </tr> </table>		-				+			<p>175W 5 - 800V 0 - 8.75A</p>				Negative terminal.		Positive terminal.	
-				+													
		<p>175W 5 - 800V 0 - 8.75A</p>															
	Negative terminal.		Positive terminal.														

<p>IMON Out</p>	 <p>I MON OUT</p>	<p>Current monitor BNC terminal: Output connector used to monitor the current by outputting a voltage. An output voltage of 10V corresponds to the full scale current for the H and L ranges. 1V corresponds to the full scale current in the M range.</p>
<p>VMON Out (LSG-175H/350H /1050H)</p>	 <p>V MON OUT</p>	<p>Voltage monitor BNC terminal: Output connector used to monitor the voltage by outputting a voltage. An output voltage of 8V corresponds to the full scale voltage.</p>
<p>TRIG OUT</p>	 <p>TRIG OUT</p>	<p>Trigger out BNC terminal: Outputs a pulse signal during sequence or dynamic operation. The trigger signal has a 4.5V output with a pulse width of a least 2us and an impedance of 500Ω.</p>
<p>LINK/STBY Indicator (LSG-2100H)</p>		<p>The LINK and STBY indicators indicate when the booster pack is properly connected and when the power has been turned on, respectively.</p>

1-3-2. Rear Panel  
 LSG-175/LSG-175H / LSG-350/LSG-350H

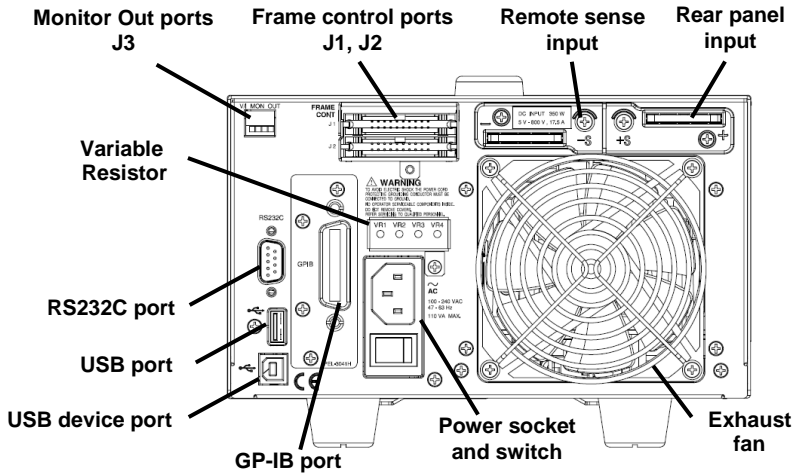

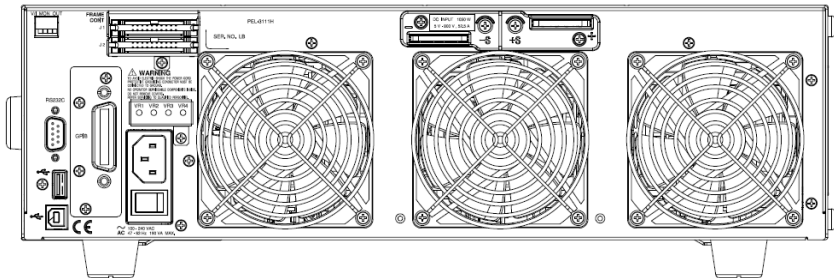

LSG-1050/LSG-1050H

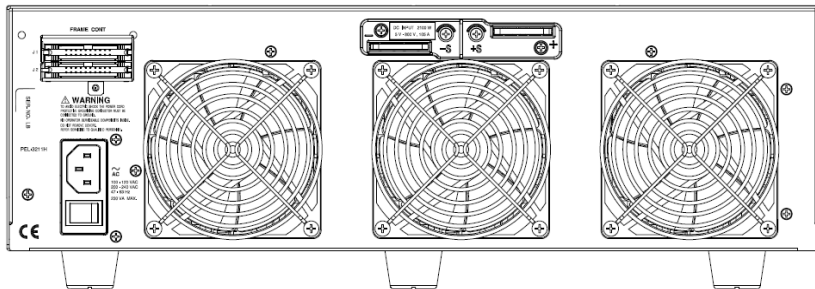

LSG-2100S/SH Booster Pack

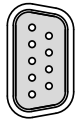

Name explanation

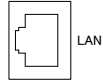
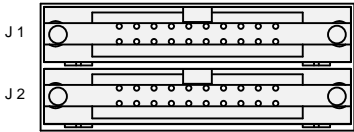
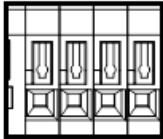
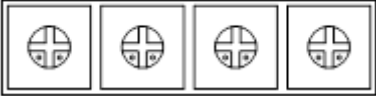
<p>RS-232C Port GP-IB USB B</p>	<p>The USB B, RS-232C and GP-IB port are used for remote control.</p>				
		<p>USB B port</p>	<p>RS-232C 9 pin D-SUB</p>	<p>GP-IB 24 pin</p>	<p>LAN RJ-45</p>
<p>Frame control ports J1, J2</p>	<p>FRAME CONT</p>				
					
	<p>J1: The J1 is assigned to external control. J2: The J2 is used for parallel operation control.</p>				
<p>Monitor Out ports J3</p>					
<p>LSG-175H/LSG-350H/LSG-1050H</p>	<p>J3: The J3 connector is assigned to current and voltage monitor out.</p>				
<p>Variable Resistor LSG-175H/LSG-350H/LSG-1050H</p>	<p>VR1</p>	<p>VR2</p>	<p>VR3</p>	<p>VR4</p>	
	<p>The variable resistors are used to adjust the full scale and offset setting for the input value of the external control sources such as voltage or resistance.</p>				
<p>Exhaust fan</p>	<p>The exhaust fan is used to expel the heat from the unit. Please ensure there is at least 20cm distance between any object and the fan.</p>				

Rear Panel Input terminals

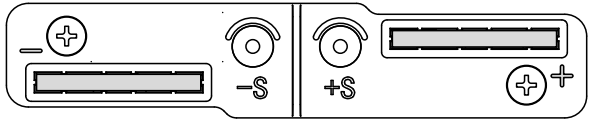

Rear Panel Input Terminals. Electrically connected to the front panel input terminals. Accepts M8 bolts or M4/M3 sized screws. See page 20 (1-4-8. Using the Rear Panel Input Terminals) for connection details.

Remote Sensing Terminals

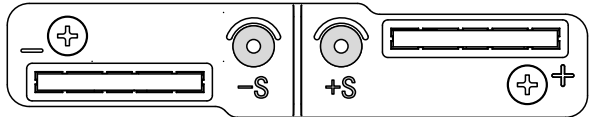

Sensing terminals for remote sense. See page 25 (1-4-11.Remote Sense). Accepts M3 sized screws.

Power Socket

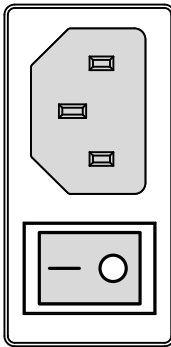

Power Socket:  
100~120V, 200~240V  
47~63Hz.

Power Switch

Turns the unit on/off.

USB A

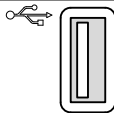

USB A Slave port. USB 1.1/2.0

1-3-3. Display

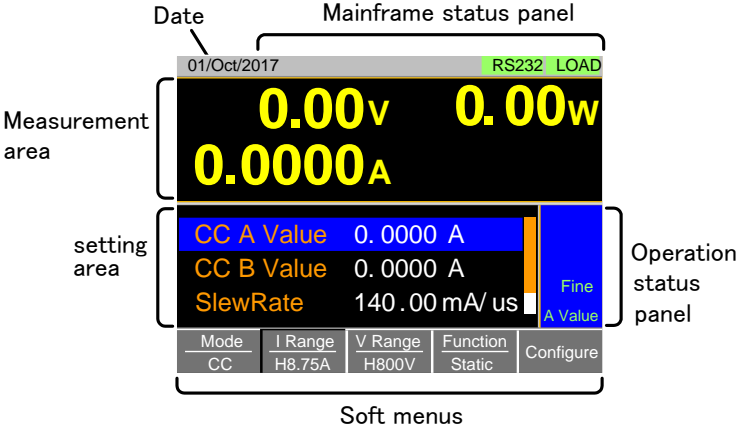

Setting area	The setting area is used to display and edit the settings for the current mode / function.
Measurement area	Displays the voltage, current and power values.
Date	Displays the date
Mainframe status panel	The mainframe status panel displays the status of the load, remote control and short function. When an icon is green it indicates that the function is off. When the icon is orange, the function is on.
Operation Status Panel	This status panel is used to display the status of the current mode.
Soft menus	The soft menus are used to select different functions or parameters.



## 1-4. First Time Use Instructions

Use the procedures below when first using the LSG Series to install the rack mount kit, power up the instrument, set the internal clock, restore the factory default settings and check the firmware version. Lastly, the Conventions section will introduce you to the basic operating conventions used throughout the user manual.

### 1-4-1. Rack Mount Kits

---

Description	<p>The LSG Series has a number of rack mount options for installation. The GRA-413 rack mounts are suitable for the LSG-2100SH booster pack. The GRA-414 rack mounts are capable of holding 1x LSG-1050H or 2x LSG-175H/LSG-350H units.</p> <p>For installation details, please see the GRA-413 and GRA-414 Rack Mount Assembly Manual.</p> <p>Please see your distributor for which rack mount is suitable for your application.</p>
-------------	---

---

GRA-413-J  
GRA-413-E  
( LSG-2100S/  
LSG-2100SH)

EIA rack:128 mm  
JIS rack:149 mm

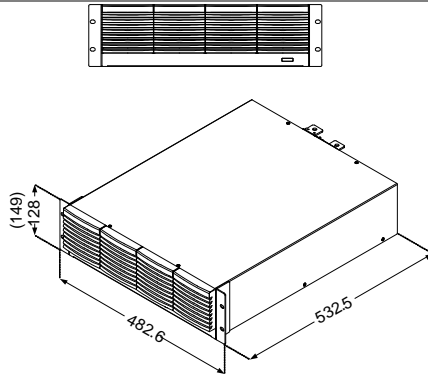

GRA-414-E  
GRA-414-J

LSG-175/175H,  
/LSG-350/350H,  
LSG-1050/1050H

EIA rack:132 mm  
JIS rack:149 mm

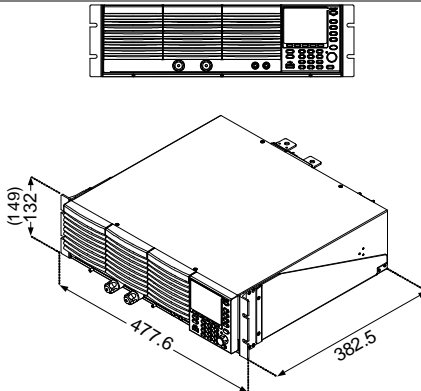

## 1-4-2. Power Up and Self-Test

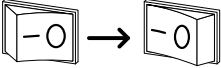
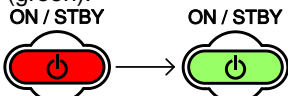
- |           |  |
|-----------|--|
| Operation | 1. Insert the AC power cord into the power socket.   |
|           | 2. Turn the external power switch on.<br>(O → —)    |
|           | 3. If the unit doesn't turn on, press the On/Standby key for a second.<br>The ON/STBY key will go from standby (red) to on (green).<br> |
|           | 4. The unit will show the splash screen and then load the settings from when the unit was last powered down.   |
|           | 5. To turn off the power, press the ON/STBY key again for a second.  |





Note

If the LSG Series fails to start up properly or does not turn on, please see your local distributor.

## 1-4-3. Load Default Settings

Description	When first using the LSG Series, recall the factory default settings to ensure the unit is in a known state. See page 174 (7-3. Default Settings) for a list of the default settings.
-------------	---

Operation	<p style="text-align: center;">File</p> <p>Press  &gt;  in order, press <i>Media/Default</i> [F1] or <i>Factory Default</i> [F2] to set.</p>
-----------	--



### 1-4-4. Setting the Date and Time

**Description** The date and time settings are used to time-stamp files when saving files.

The date and time is shown on top of the LCD display.

**Operation**

Utility

Press **Shift** > **Help** > *Time Set* [F4] in order, and set the date and time.

Settings: Month, Day, Year, Hour, Minute

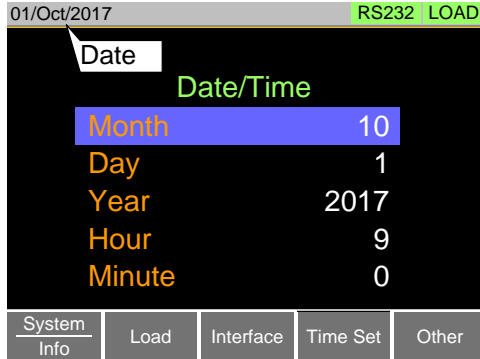

## 1-4-5. Load Wiring

### Wire Gauge considerations

Before connecting the unit to a power source, the wire gauge must be taken into account. Load wires must be large enough to resist overheating when a short-circuit condition occurs as well as to maintain a good regulation. The size, polarity and length of a wire are all factors in determining if a wire will withstand short circuiting. Wires that are selected must be large enough to withstand a short circuit and limit voltage drops to no more than 2V per wire. Use the table below to help make a suitable selection.

AWG Gauge	Conduct or Diameter mm	Ohms / km	Max amps for chassis wiring
0000	11.684	0.16072	380
000	10.4038	0.2027	328
00	9.26592	0.25551	283
0	8.25246	0.32242	245
1	7.34822	0.40639	211
2	6.54304	0.51266	181
3	5.82676	0.64616	158
4	5.18922	0.81508	135
5	4.62026	1.02762	118
6	4.1148	1.29593	101
7	3.66522	1.6341	89
8	3.2639	2.0605	73
9	2.90576	2.59809	64
10	2.58826	3.27639	55
11	2.30378	4.1328	47
12	2.05232	5.20864	41
13	1.8288	6.56984	35
14	1.62814	8.282	32
15	1.45034	10.44352	28
16	1.29032	13.17248	22
17	1.15062	16.60992	19
18	1.02362	20.9428	16
19	0.91186	26.40728	14
20	0.8128	33.292	11
21	0.7239	41.984	9

---

Load Line  
Inductance  
Considerations

When using the LSG Series load generator, voltage drop and voltage generated due to load line inductance and current change must be taken into account. Extreme changes in voltage may exceed the minimum or maximum voltage limits. Exceeding the maximum voltage limit may damage the LSG Series.

To determine the voltage generated, the following equation can be used.

$$E = L \times (\Delta I / \Delta T)$$

E= voltage generated

L=load line inductance

$\Delta I$  = change of current (A)

$\Delta T$  = time (us)

Load line inductance (L) can be approximated as 1uH per 1 meter of wire. ( $\Delta I / \Delta T$ ) is the slew rate in A/us.

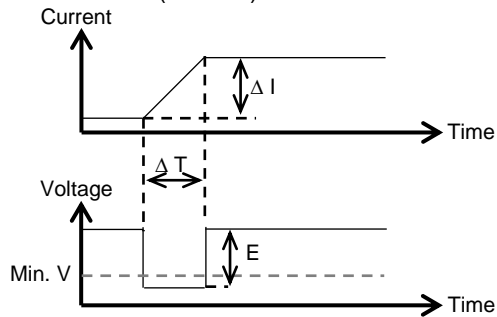



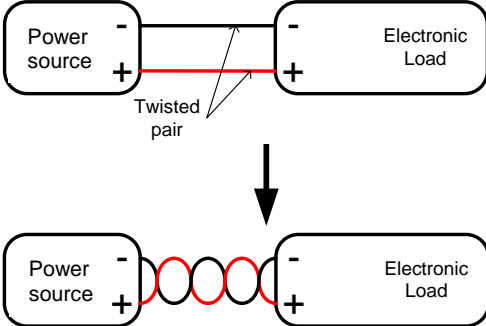

The diagram above shows how changes in current can affect voltage.

---

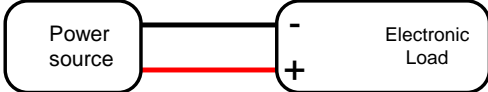
Limiting Load line inductance	Load line inductance can be reduced in two methods.
Method 1	<p>Ensure load wires are as short as possible and twist the positive and negative load wires together.  “Twisted pair” will be shown on any connection diagram where the load wires should be twisted together.</p> 
Method 2	Current change can be limited by limiting the slew rate or response speed when switching in CR and CC mode.

#### 1-4-6. Load Wire Connections

Description	<p>The LSG Series has input terminals on both the front and rear panels.  Follow the procedures below for all load connections.  Please adhere to the following precautions to ensure your safety and to protect the unit from damage.</p>
Connection	<p>When connecting the LSG Series to the power source, make sure that the polarity of the connection between the DUT and the unit matches.  Ensure that the maximum input voltage is not exceeded. The maximum input voltage is 800 volts.</p> 
 Caution	If the polarity to the input terminals is reversed, the reverse voltage protection function is tripped. The reverse voltage protection function is tripped when reverse voltages greater than about -0.3V are detected.
 Warning	Do not touch any of the input terminals when the voltage is applied to an input terminal.
 Warning	Connecting the input terminals to the wrong polarity can damage the power source or the LSG Series.
 Warning	The front panel and rear panel input terminals are physically connected. Any voltage that is input to one set of terminals will also appear on the other set of terminals.

## 1-4-7. Using the Front Panel Input Terminals

---

**Description** The front panel input terminals feature polarity-distinct caps and accept M6 sized crimped terminals.

---



**Caution**

The front panel input terminals on the LSG Series are physically connected to the rear panel terminals.

---

**Step**

1. Turn the power off from the rear panel or put the unit into standby mode.
2. Turn the power off from the power source.
3. Connect the load wires to the input terminals:  
Connect the positive (+) input terminal on the load generator to the high potential output of the power source.  
Connect the negative (-) input terminal to the low potential output of the power source.

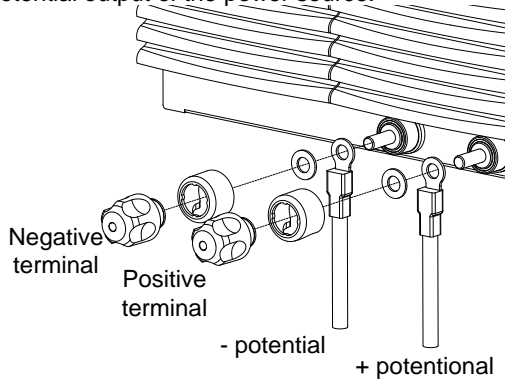

## 1-4-8. Using the Rear Panel Input Terminals

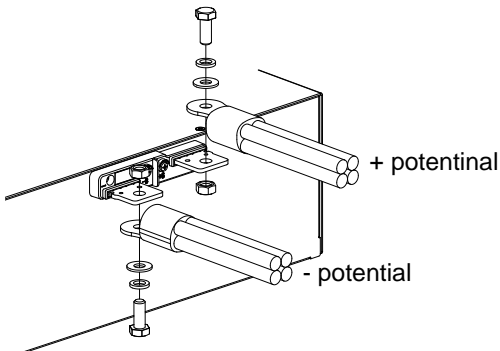
Description	The rear panel input terminals accept up to M8-sized crimped terminals. The rear terminals come with a load input terminal cover for safety.
 Caution	The front panel input terminals on the LSG Series are physically connected to the rear panel terminals.
Steps	<ol style="list-style-type: none"><li>1. Turn the power off from the rear panel or put the unit into standby mode.</li><li>2. Turn the power off from the power source.</li><li>3. Connect the load wires to the input terminals: Connect the positive (+) input terminal on the load generator to the high potential output of the power source. Connect the negative (-) input terminal to the low potential output of the power source.</li></ol>
	



## 1-4-9. Using the Terminal Cover (PEL -011)

Description

The rear panel terminal cover should be used to prevent electric shock. The rear panel terminal covers should always be used when connecting a load to the rear panel terminals. As the front panel and rear panel terminals are physically connected, the terminal cover should also be used as a safety measure when a power source is connected to the front terminals



Caution

Ensure the power is off before making any connections to the LSG Series.

Note: In the following diagrams, the cable wiring is not shown for clarity.

Steps(1/2)

1. Remove the screw holding the top cover to the bottom cover.

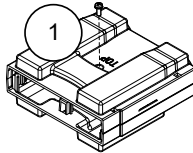

2. Line-up the bottom covers with the notches in the output terminals.
3. Place the top terminal cover over the bottom cover.

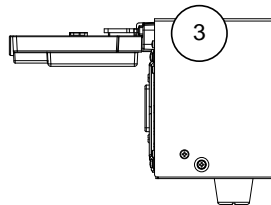
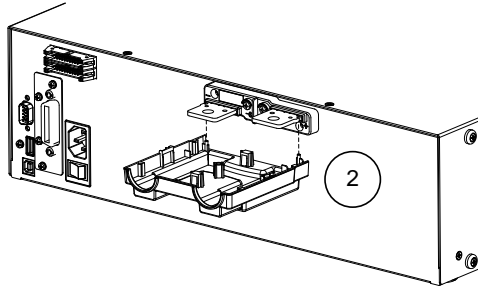

Steps(2/2)

- 
- 4. Use your thumb to slide the terminal covers shut, as shown in the diagram below.

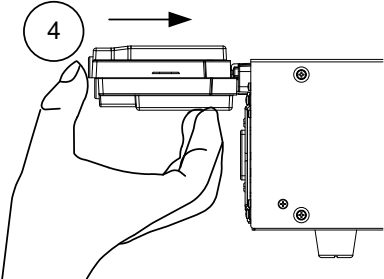

- 
- 5. When the top and bottom covers are flush, reinsert the screw that was removed in step 1.

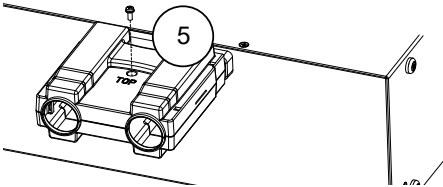

## 1-4-10. Using the Terminal Cover (PEL -013)

Description

The flexible rear panel terminal cover should be used when the load wiring becomes too thick to be used with the PEL-011 terminal cover. This is especially true when using the load generators in parallel. Like the PEL-013 terminal cover, the PEL-011 is used to prevent electric shock. The rear panel terminal covers should always be used when connecting a load to the rear panel terminals.



Caution

Ensure the power is off before making any connections to the booster pack.

Steps

1. Wrap the insulation sheets around the terminals and load cables, as shown below. Make sure the terminals and any exposed wires are covered by the sheets.

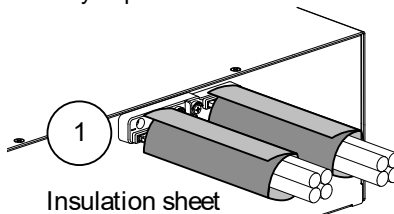

2. Secure the insulation sheets using the supplied velcro fasteners. 2 fasteners should be used for each sheet.

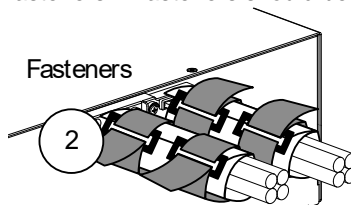

### 1-4-11. Using the Terminal Cover

Description	After connection is finished, please lock terminal cover to avoid electric shock when using the frame control terminal.
 Caution	Ensure the power is off, before making any connections to the booster pack.
Steps	Install the terminal cover as shown in the picture below.

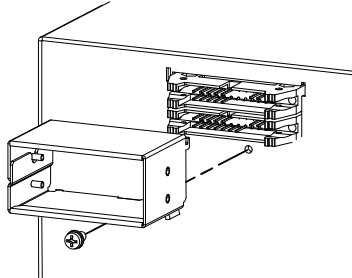

LSG-H Series

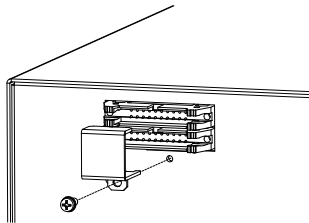

LSG Series

### 1-4-12. Using the Monitor out Cover

Description	After connection is finished, please lock monitor out cover to avoid electric shock when not using the monitor out ports.
-------------	---

Steps	
-------	--

### 1-4-13. Remote Sense

---

Description	Remote sense can be used to help compensate for long cable length. The longer the cable, the higher the potential resistance and inductance, therefore a short cable is best. Twisting the cable can help reduce induced inductance and using the remote sensing terminals compensates the voltage drop seen across the load leads, especially leads with higher resistance. This is useful when used in CV, CR or CP mode.
Steps	<ol style="list-style-type: none"><li>1. Turn the power off from the rear panel or put the unit into standby mode.</li><li>2. Turn the power off from the power source.</li><li>3. Connect the sense wires to the remote sensing terminals: Connect the positive sense (+S) terminal to the high potential output of the power source. Connect the negative sense (-S) terminal to the low potential output of the power source.</li></ol>

---

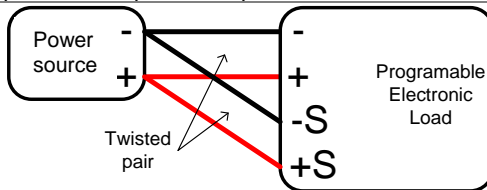



## 1-4-14. Firmware Update

Description	The LSG Series allows the firmware to be updated by end-users. Before using the LSG Series, please check the <a href="http://www.texio.co.jp">TEXIO TECHNOLOGY</a> website or ask your local distributor for the latest firmware.
-------------	---



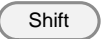

Caution

Before updating the firmware, please check the firmware version.

Operation System version	<p style="text-align: right; margin-right: 20px;">Utility</p> <ol style="list-style-type: none"> <li>1. Press  &gt;  in order.</li> <li>2. Select <i>System/Info</i> [F1].</li> <li>3. The System information is listed on the LCD display. Model: Model number of the LSG-H. Serial Number: Serial number of the LSG-H. Firmware Ver: Firmware version of the LSG-H. http: Texio website address.</li> <li>4. To view other system information, press <i>System</i> [F1] and select <i>Memo</i>.</li> </ol>
-----------------------------	--

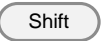

Operation Update Firmware	<ol style="list-style-type: none"> <li>1. Insert a USB drive into the USB port. Ensure the USB drive has the firmware file located in the root directory.</li> <li>2. Press  &gt;  in order.</li> <li>3. Select USB with the <i>Media</i> [F1] soft-key.</li> <li>4. Press the <i>File Utility</i> [F5] soft-key.</li> <li>5. Select the *.UPG upgrade file and press <i>Select</i> [F1] twice. Once to select the file and once to confirm.</li> <li>6. Wait for the update to complete and reset the power when prompted.</li> </ol>
------------------------------	--



Caution

Do not turn the load generator off or remove the USB drive when the firmware is being read or upgraded.

## 1-4-15. Conventions

The following conventions are used throughout the user manual. Read the conventions below for a basic grasp of how to operate the LSG Series menu system using the front panel keys.

**Soft Menu** The F1 to F5 function keys at the bottom of the LCD display correspond directly to the soft menus on top.

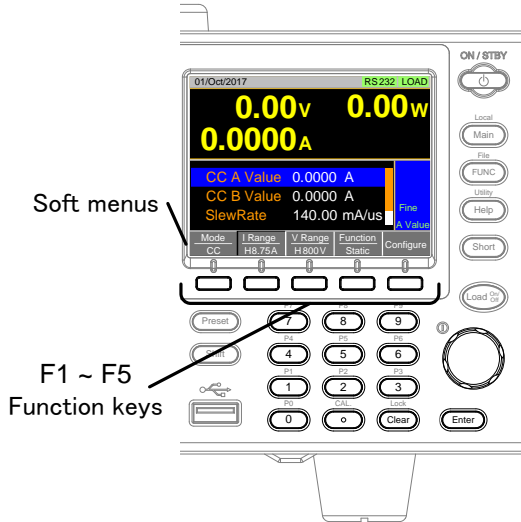

Select Sub Menu

Configure

Pressing this type of soft menu will enter a submenu.

Toggle  
Parameter  
or State

Function/Item



Parameter or State

This type of soft-menu icon has the function /item on the top of the label and the selected setting or mode on the bottom of the label.

Repeatedly press the associated function key (F1~F5) to cycle through each setting. For example, repeatedly pressing the F1 key will cycle through the CC, CR, CV and CP modes.

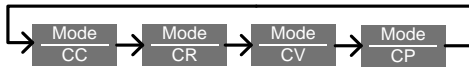

For some parameters, a popup window will also appear. Selection of the setting is the same. Repeatedly pressing the relevant function key (F1~F5) will cycle through each setting. The selection on the popup window will also be reflected on the label.

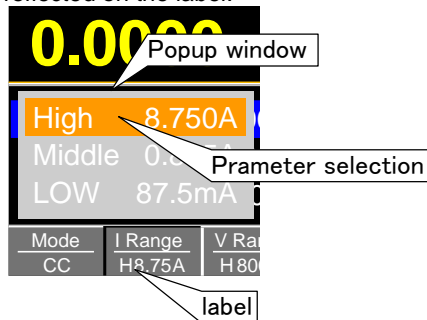



## Parameter Input

The scroll wheel, Enter key and number pad can be used to edit parameter values.

### Number pad

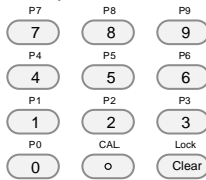

### Scroll wheel



Enter key

1. Use the scroll wheel to move the cursor to the desired parameter.  
A scroll bar is shown when there are additional parameters off-screen.

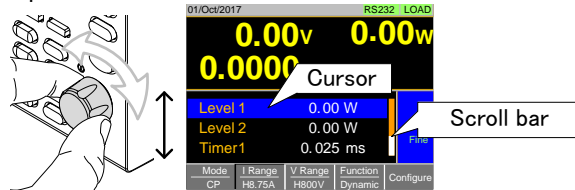

2. Press the Enter key to select the parameter. The parameter will become highlighted in white.

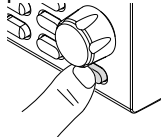

3. Then use the number pad\* or scroll wheel\*\* to edit the parameter value.

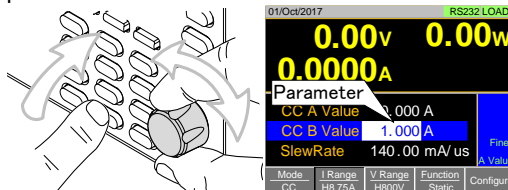

The parameter value is canceled when press the Clear key.

4. Press the Enter key again to finish editing the parameter value.

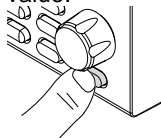

Using the Scroll Wheel to Edit a Parameter\*\*

\*\*To edit a parameter using the scroll wheel, simply turn the scroll wheel. Clockwise increases the value, counterclockwise decrease the value. Pressing the scroll wheel when a parameter is highlighted allows you to change the step resolution. There are two different step resolution methods: Step Mode and Cursor Mode.

Step Mode

This is the default step resolution method and will only be available to use when it is applicable (Indicated by Fine or Coarse in the Operation Status panel). When a parameter is highlighted (step 3 above) pressing the scroll wheel will toggle the step resolution between fine and coarse. For details on how to set the step resolution



Cursor Mode

This method must first be enabled before it can be used. Pressing the scroll wheel when a parameter is highlighted allows you to set the step resolution by a digit value. An orange line will appear under the currently selected digit value. Repeatedly pressing the scroll wheel moves to the next digit.

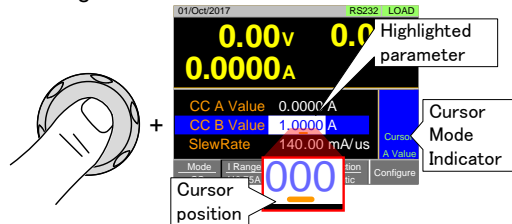

---

Entering  
Alphanumeric  
Characters

When renaming files, creating memos or notes, you will be required to enter alphanumeric characters when the character entry screen appears. Only alphanumeric characters as well as space [ ], underscore [ \_ ] and minus [ - ] characters allowed.

---

1. Use the scroll wheel to move the cursor to the desired character.

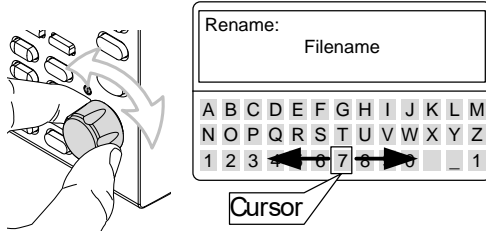

2. Press the **Enter** key or *Enter Character* [F1] to select a character.

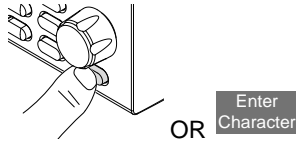

3. To delete a character, press *Back Space* [F2].
  4. To save the file name or memo, press *Save* [F3].
-

## 1-4-16. Help Menu

When any function key has been pressed or when a menu has been opened, the HELP key can be used to display a detailed description.

- 
- Help Menu
1. Press any function key or soft-menu key.
  2. Press **Help** to see the help contents on that particular function key or menu.
  3. Use the scroll to navigate the help contents.
  4. Press the *Exit* [F5] key to exit the help menu.
- 

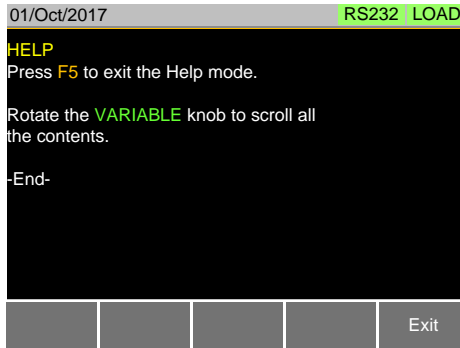



## 2. OPERATION

### 2-1. Basic Operation

The LSG Series supports 7 main operating modes:

CC, CC+CV, CR, CR+CV, CV, CP, CP+CV

#### 2-1-1. CC Mode

Description	In Constant Current Mode the load units will sink the amount of current programmed. Regardless of the voltage, the current will stay the same. For more details on CC mode, please see the appendix on page 181 (7-5-1. CC Mode).
 Warning	If you change the mode or the range when the load is already on, the load will be turned off automatically.
Operation	<ol style="list-style-type: none"><li>1. Make sure the load is off.</li><li>2. Press .</li><li>3. Select CC mode with the <i>Mode</i> [F1] soft-key.</li><li>4. Select the current range with the <i>I Range</i> [F2] soft-key. I Range: High, Middle, Low</li><li>5. Select the voltage range with the <i>V Range</i> [F3] soft-key. V Range: High, Low</li><li>6. Set the current level parameters using the scroll wheel and number pad. For Static mode, set <i>CC A Value</i> and /or <i>CC B Value</i>. For Dynamic mode, set <i>Level1</i> and <i>Level2</i>. The maximum and minimum current levels depend on the selected ranges.</li><li>7. To add CV mode to CC mode (CC+CV), see page 39 (2-1-6. +CV Mode).</li><li>8. Set the remaining basic configuration settings such as the slew rate, and switching function settings. See page 44 (2-2. Basic Configuration) for details.</li></ol>

Display

01/Oct/2017 RS232 LOAD

0.000V 0.00W

Current setting A Active setting

Current setting B

CC A Value 0.0000 A

CC B Value 0.0000 A

Mode SlewRate 140 Voltage range

Mode	I Range	VRange	Function	Configure
CC	H 8.75A	L 80V	Static	



Current range



Note

Basic CC mode configuration is complete. See page 44 (2-2. Basic Configuration) for more configuration options. The current range and voltage range applies to all the operating modes.

## 2-1-2. CR Mode

Description	<p>In Constant Resistance Mode, the unit will maintain a constant resistive load by varying the current. CR mode uses <math>\Omega</math> (resistance) or S (conductance) for the setting units.</p> <p>For more details on CR mode, please see the appendix on page 182 (7-5-2.CR Mode).</p>
 Warning	<p>If you change the mode or the range when the load is already on, the load will be turned off automatically.</p>
Operation	<ol style="list-style-type: none"> <li>1. Make sure the load is off.</li> <li>2. Press .</li> <li>3. Select CR mode with the <i>Mode</i> [F1] soft-key.</li> <li>4. Select the current range with the <i>I Range</i> [F2] soft-key. I Range: High, Middle, Low</li> <li>5. Select the voltage range with the <i>V Range</i> [F3] soft-key. V Range: High, Low</li> <li>6. Set the resistance or conductance level parameters using the scroll wheel and number pad. For Static mode, set <i>CR A Value</i> and/or <i>CR B Value</i>. For Dynamic mode, set <i>Level1</i> and <i>Level2</i>. The maximum and minimum conductance/ resistance levels depend on the selected current range.</li> <li>7. To add CV mode to CR mode (CR+CV), see page 39 (2-1-6. +CV Mode).</li> <li>8. Set the remaining basic configuration settings such as the slew rate, and switching function settings. See page 44 (2-2. Basic Configuration) for details.</li> </ol>

### Display

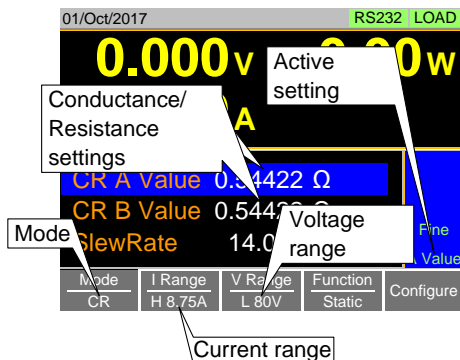



Note

Basic CR mode configuration is complete. See page 44 (2-2. Basic Configuration) for more configuration options. The current range and voltage range applies to all the operating modes.

---

### 2-1-3. CR Units

---





Description	The CR setting units can be set to $\Omega$ (resistance) or mS (conductance).
-------------	---

---



- |           |  |
|-----------|--|
| Operation | <ol style="list-style-type: none"><li>1. Make sure the load is off.</li><li>2. Press  &gt; <i>Configure</i> [F5] &gt; <i>Other</i> [F2] in order, and set the <i>CR Unit</i> setting.<br/>CR Unit: <math>\Omega</math> or mS for the setting units.</li></ol> |
|-----------|--|
-

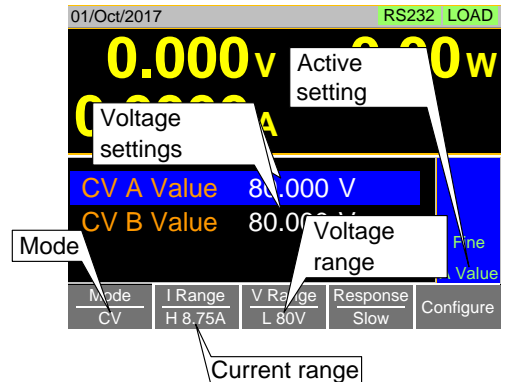

## 2-1-4. CV Mode

Description	In Constant Voltage Mode, the unit will maintain a constant voltage. In CV mode you set the constant voltage level. For more details on CV mode, see the appendix on page 184 (7-5-4.CV Mode).
 Warning	If you change the mode or the range when the load is already on, the load will be turned off automatically.
Operation	<ol style="list-style-type: none"> <li>1. Make sure the load is off.</li> <li>2. Press  .</li> <li>3. Select CV mode with the <i>Mode</i> [F1] soft-key.</li> <li>4. Select the current range with the <i>I Range</i> [F2] soft-key. I Range: High, Middle, Low</li> <li>5. Select the voltage range with the <i>V Range</i> [F3] soft-key. V Range: High, Low</li> <li>6. Set the voltage level parameters using the scroll wheel and number pad. Set CV A Value and/or CV B Value. The maximum and minimum voltage levels depend on the selected voltage range.</li> <li>7. Set the remaining basic configuration settings such as the response settings. See page 44 (2-2. Basic Configuration) for details.</li> </ol>
Display	
 Note	Basic CV mode configuration is complete. See page 44 (2-2. Basic Configuration) for more configuration options. The current range and voltage range applies to all the operating modes.

## 2-1-5. CP Mode

Description	In Constant Power Mode, the unit will maintain a constant power by varying the current. For more details on CP mode, see the appendix on page 183 (7-5-3.CP Mode).
 Warning	If you change the mode or the range when the load is already on, the load will be turned off automatically.
Operation	<ol style="list-style-type: none"> <li>1. Make sure the load is off.</li> <li>2. Press  .</li> <li>3. Select CP mode with the <i>Mode</i> [F1] soft-key.</li> <li>4. Select the current range with the <i>I Range</i> [F2] soft-key. I Range: High, Middle, Low</li> <li>5. Select the voltage range with the <i>V Range</i> [F3] soft-key. V Range: High, Low</li> <li>6. Set the power level parameters using the scroll wheel and number pad. For Static mode, set <i>CP A Value</i> and/or <i>CP B Value</i>. For Dynamic mode, set <i>Level1</i> and <i>Level2</i>. The maximum and minimum power levels depend on the selected current range. For static mode, the parameter that is set last becomes the “active” setting. This will be shown in the Operation Status Panel.</li> <li>7. To add CV mode to CP mode (CP+CV), see page 39 (2-1-6. +CV Mode).</li> <li>8. Set the remaining basic configuration settings such as the slew rate, and timer settings. See page 44 (2-2. Basic Configuration) for details.</li> </ol>

### Display

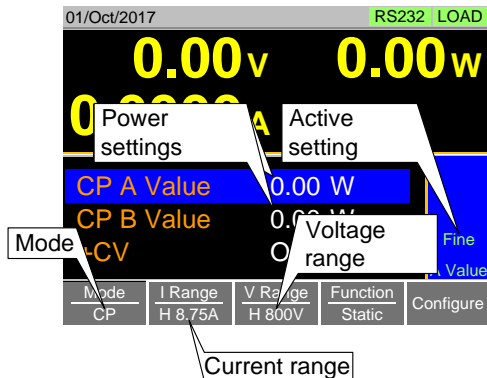



Note

Basic CP mode configuration is complete. See page 44 (2-2. Basic Configuration) for more configuration options. The current range and voltage range applies to all the operating modes.

## 2-1-6. +CV Mode

Description	+CV mode can be added to CC, CR and CP mode. The +CV settings apply to all applicable modes.
Operation	<ol style="list-style-type: none"> <li>1. Make sure the load is off.</li> <li>2. Press <b>Main</b> . And select to Mode, I Range, and V Range.</li> <li>3. Set the +CV voltage level. (You may need to scroll down to the +CV setting) +CV: OFF ~ rated voltage+5%</li> </ol>

Display

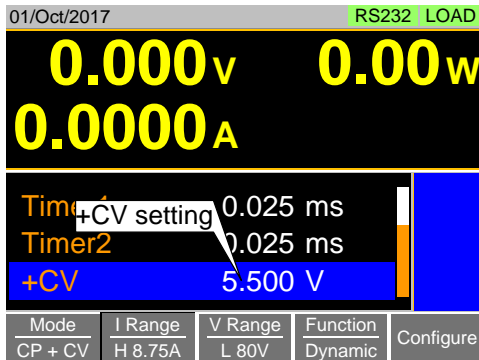

Note

The +CV settings apply to all the applicable operating modes.





For example: The +CV settings made in CR mode will be carried over to the +CV settings in CC and CP mode.







Note

Only in +CV settings, the external control is not possible. See page 141 (4-1-3. External Voltage Control – Operation) for +CV settings with external control.



## 2-1-7. Turning on the Load

Description	<p>The load can be turned on and off by pressing the  key.</p> <p>The  key will turn orange when the load is “on”. The LOAD icon in the mainframe status panel will turn orange when the load is on.</p>
Display	
 Note	<p>The load can be set to automatically turn on at start up. See page 56 (2-3-4. Auto Load Configuration).</p> <p>The load can be turned on via remote control. See the programming manual.</p> <p>The load can be turned on via external control. See page 148 (4-1-8. Turning the Load On using External Control).</p> <p>By default the load will automatically turn off if the range or operating mode (CC, CV, CR, CP) is changed. To disable this behavior, Set Load Off (Mode) and Load Off (Range) to the OFF setting. See page 56 (2-3-5. Load Off (Mode) and Load Off (Range)) for details.</p>



## 2-1-8. Shorting the Load

Description	<p>The Short key can be used to simulate a short circuit of the load input terminals. A short circuit is simulated by:</p> <ul style="list-style-type: none"><li>Setting the current to the maximum value in CC mode.</li><li>Setting the resistance to the minimum value in CR mode.</li><li>Setting the voltage to the minimum value in CV mode.</li><li>Setting the power to the maximum value in CP mode.</li></ul> <p>When the load is shorted, the external controller also sends a short signal. See page 152 (4-1-15. Short Control) for usage details.</p>
Operation	<p>The short function can be turned on and off by pressing the  key.</p> <p>The  key will turn red when the short function is active.</p> <p>The Short icon will appear when the short function is active.</p>
Display	 <p>The screenshot shows a digital display with a date '01/Oct/2017' on the left. In the center, 'SHORT on' is displayed in white text on a black background. To the right, 'SHORT RS232 LOAD' is shown in green and orange. At the bottom, '0 100v 0 10w' is displayed in large yellow digits on a black background.</p>
 Note	<p>If the load is already off, pressing the Short key will turn the load on (shorted) at the same time.</p> <p>Pressing the Short key again will also turn the load off again as well.</p> <p>If the load is already on and the Short key is pressed, then when the Short key is pressed again the load will remain on (the electronic load will return to its previous load condition).</p> <p>The Short key will be disabled if the Short Function setting is turned off. See page 42 (2-1-11.Short Function Enable/Disable) for details.</p>

## 2-1-9. Safety Short

Description	When activated, the safety short function only allows the short key to be used when the load is already on.
Operation	Press  > <i>Configure</i> [F5] > <i>Other</i> [F2] in order, and set the Short Safety. When set to OFF, the load can be shorted at any time. When set to ON, the load can only be shorted when the load is already on. Short(Safety): OFF,ON
 Note	The Short Safety setting will be grayed out if Short Function is set to OFF. See page 42 (2-1-11.Short Function Enable/Disable) for Short Function.



## 2-1-10. Short Key Configuration

Description	The Short key can be configured to Toggle or Hold. By Default the Short key is set to Toggle. Toggle: Pressing the Short key will toggle the shorting function on or off. Hold: Holding the short key will short the load.
Operation	Press  > <i>Configure</i> [F5] > <i>Other</i> [F2] in order, and set the <i>Short Key</i> setting. Short Key: Toggle, Hold
 Note	The Short Safety setting will be grayed out if Short Function is set to OFF. See page 42 (2-1-11.Short Function Enable/Disable) for Short Function.

## 2-1-11. Short Function Enable/Disable

Description	The short key can be disabled to prevent the operator accidentally shorting the load.
Operation	Press  > <i>Configure</i> [F5] > <i>Other</i> [F2] in order, and set the <i>Short Function</i> . When set to OFF, the Short key is disabled and all short configuration options in the Main > Configure> Other menu are also disabled. When set to ON, the Short key is enabled. Short Function: OFF,ON

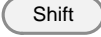
## 2-1-12. Locking the Front Panel Controls

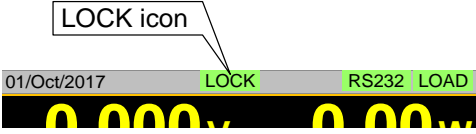
Description	The keys and scroll wheel on the front panel can be locked to prevent settings from being changed.
Operation	The keys can be locked and unlocked by press  >  in order. The  key will not be locked if the load is on.
Display	LOCK will appear in the Mainframe status panel when the keys are locked. 

## 2-2. Basic Configuration

The basic configuration settings are the common configuration settings that are used for each operating mode. After selecting a basic operating mode (CC, CR, CV and CP mode), the slew rate, switching function, response rate and other common parameters should be configured.

### 2-2-1. Select the Switching Function

Description	<p>The LSG Series has two switching function, static mode and dynamic mode. The switching function allows the LSG Series to switch between two preset levels. Static mode can only switch between the two levels manually, while Dynamic mode switches between each level automatically based on a timer.</p> <p>Static mode: A Value, B Value          Dynamic mode: Level1, Level2</p> <p>When the unit is set to static mode, only one value (A Value or B Value) can be active at a time. The active value is shown in the operation status panel.</p>
-------------	--

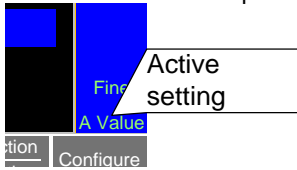

When the unit is set to dynamic mode, the unit will switch between Level1 and Level2 based on the Timer1 and Timer2 parameters, shown below.

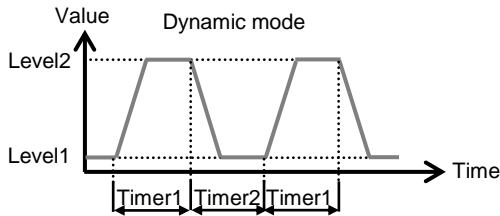

Note

Dynamic mode is not available for CV mode.



- 
- Operation
1. Make sure the load is off.
  2. Press **Main**.
  3. Select Dynamic or Static mode with the *Function* [F4] soft-key.  
A different switching mode can be set for CC, CR and CP mode.
  4. See page 45 (Static Mode Operation) for Static Mode.  
See page 46 (Dynamic Mode Operation) for Dynamic Mode.
- 

Static Mode Operation

For static mode, select whether A Value or B Value is the “active” setting, press the **Shift** > **Preset** keys. The “active” value will be shown in the Operation Status Panel. The load can be “on” when switching between A Value and B Value.

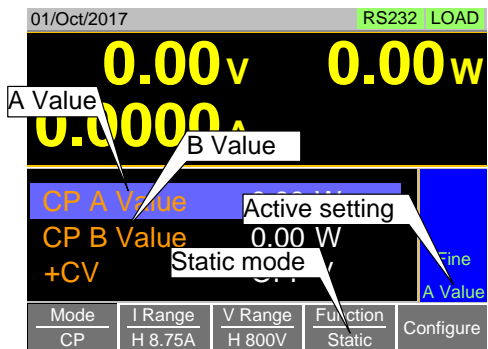

---

Dynamic Mode  
Operation

For dynamic mode, set the Timer1 and Timer2 parameters using the scroll wheel and number pad. Timer1 sets the Level1 on-time. Timer2 sets the Level2 on-time. Take the slew rate settings into consideration when setting the timers.

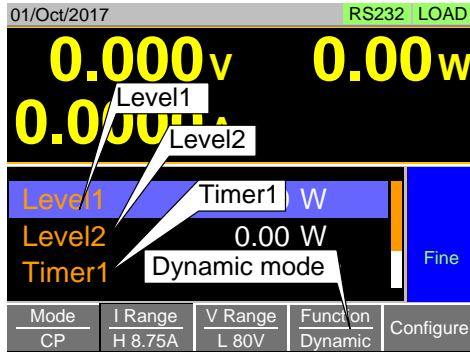

The frequency of the dynamic switching is output via the TRIG OUT BNC.

---

## 2-2-2. Select the Display Units for Dynamic Mode Levels

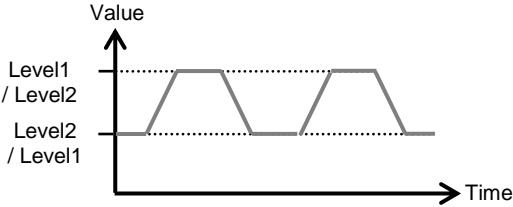
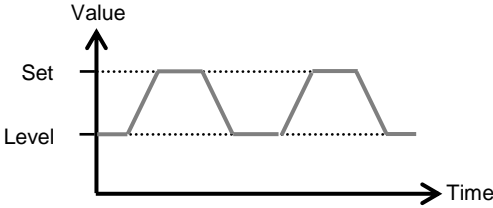
Description	<p>When Dynamic mode is selected, the Level1 and Level2 values can be set to either discrete values or as a percentage of a set value.</p> <p>The setting applies to all applicable operation modes. By default the units are set to Value.</p> <p>When Percent is chosen, 100% = 100% of the Set power, current or resistance value.</p>
Operation	<ol style="list-style-type: none"><li>1. Make sure the load is off.</li><li>2. Press <b>Main</b> &gt; <i>Configure</i> [F5] &gt; <i>Other</i> [F2] in order, and set the <i>Dyna. Level</i> setting. Dyna. Level: Value, Percent</li></ol> <p>Note: Select of "Dyna. Level" is not available for CV mode.</p>
Value Setting	
Percent Setting	

### 2-2-3. Select the Switching Time Configuration for Dynamic Mode

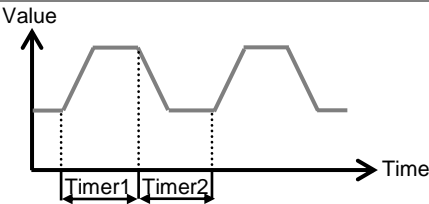
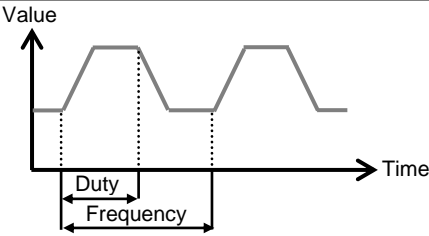
Description	The switching time for dynamic mode can be configured to switch between two preset on-times (Timer1, Timer2) or by setting a switching frequency and duty cycle.
Operation	Press <b>Main</b> > <i>Configure</i> [F5] > <i>Other</i> [F2] in order, and set the <i>Dyna. Time</i> setting. Dyna. Time: T1/T2 Freq, Duty Note: Select of "Dyna. Time" is not available for CV mode.
T1/T2 Setting	 <p>The graph plots Value on the vertical axis and Time on the horizontal axis. It shows two trapezoidal pulses. The first pulse is labeled 'Timer1' and the second is labeled 'Timer2'. Vertical dashed lines indicate the start and end of each pulse.</p>
Freq,Duty Setting	 <p>The graph plots Value on the vertical axis and Time on the horizontal axis. It shows two trapezoidal pulses. The first pulse is labeled 'Duty' and the second is labeled 'Frequency'. Horizontal arrows indicate the duration of each pulse and the time between the start of the two pulses.</p>

## 2-2-4. Slew Rate

Description	<p>The current slew rate can be set for CC and CR mode. The slew rate setting is used to limit the change in current when switching.</p> <p>For static mode, only a single slew rate can be set.</p>
Operation	<ol style="list-style-type: none"><li>1. Make sure the load is off.</li><li>2. Press <b>Main</b>.</li><li>3. Set the slew rate(s) using the scroll wheel and number pad.</li></ol> <p>For static mode, only a single slew rate can be set. For dynamic mode, set both the rising and falling slew rates.</p> <p>Take the timer settings into consideration when setting the slew rates.</p> <p>Note: Slew rate setting is not available for CP and CV mode.</p>

Dynamic mode

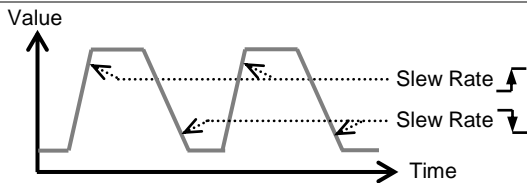

Static mode

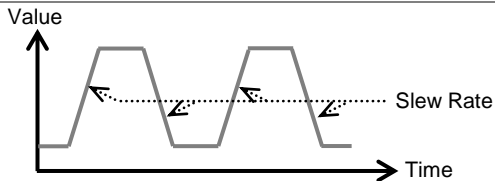

## 2-2-5. CV, +CV Mode Response Speed

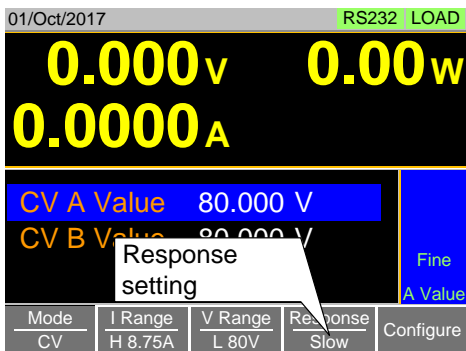
Description	<p>The response speed setting is the response speed for the negative feedback control of the load current when used in CV, +CV mode. Response speed settings are only applicable to CV, +CV mode.</p> <p>Response speed settings of the +CV mode becomes same as Response speed settings of the CV mode. With the +CV mode, Response speed settings is not displayed.</p> <p>The response speed is different from CV mode with the +CV mode.</p> <p>A response speed that is too fast could cause the unit to be unstable.</p> <p>Reducing the response speed can improve stability.</p>
Operation	<ol style="list-style-type: none"> <li>1. Make sure the load is off.</li> <li>2. Press <b>Main</b> , and make sure the unit is in CV mode by using the <i>Mode</i> [F1] soft-key.</li> <li>3. Select the response speed with the <i>Response</i> [F4] soft-key.</li> </ol> <p>Response: Fast, 6, 5, 4, 3, 2, 1, Slow (LSG-H) Fast, Slow (LSG)</p> <p>CV mode: The response speed settings Fast, 6, 5, 4 are the same.</p> <p>+CV mode: The response speed settings 5 and 4 are the same. The response speed settings Slow and 1 is the same.</p>
Display	 <p>01/Oct/2017 RS232 LOAD</p> <p>0.000V 0.00W</p> <p>0.0000A</p> <p>CV A Value 80.000 V</p> <p>CV B Value 80.000 V</p> <p>Response setting</p> <p>Mode CV I Range H 8.75A V Range L 80V Response Slow Configure</p>

## 2-2-6. CC, CR and CP Mode Response Speed

---

Description	By default, the “normal current response” speed is set to 1/1. The response speed can be reduced to 1/2, 1/5, 1/10. Reducing the current response speed can affect other settings such as the slew rate and soft start settings.
Operation	<ol style="list-style-type: none"><li>1. Make sure the load is off.</li><li>2. Press  &gt; <i>Configure</i> [F5] &gt; <i>Other</i> [F2] in order, and set the <i>Response</i> parameter. Response: 1/1, 1/2, 1/5, 1/10</li></ol>

---

## 2-3. Advanced Configuration Settings

Use the advanced configuration settings to configure settings other than those described in the basic configuration chapter.

### 2-3-1. Soft Start Setting

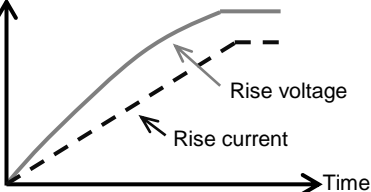
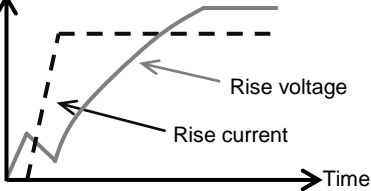
Description	<p>The soft start setting is used to limit the amount of input current at start-up or from when the Von Voltage threshold is tripped.</p> <p>The soft start setting only applies to CC, CR and CP mode.(CP mode only for LSG Series)</p>
	<div style="display: flex; flex-direction: column; align-items: center;"> <div style="text-align: center; margin-bottom: 20px;"> <p><b>Soft Start: ON</b></p>  </div> <div style="text-align: center;"> <p><b>Soft Start: OFF</b></p>  </div> </div>
Operation	<p>Press <b>Main</b> &gt; <i>Configure</i> [F5] &gt; <i>Other</i> [F2] in order, and set the <i>Soft Start</i> time.</p> <p>Soft Start:    OFF, 1~200ms        (LSG)</p> <p>                  OFF, 3~200ms        (LSG-H)</p>



## 2-3-2. Von Voltage Settings

### 2-3-2-1. Von Voltage Level

**Description** The Von Voltage is the threshold voltage at which the load module will start to sink current.

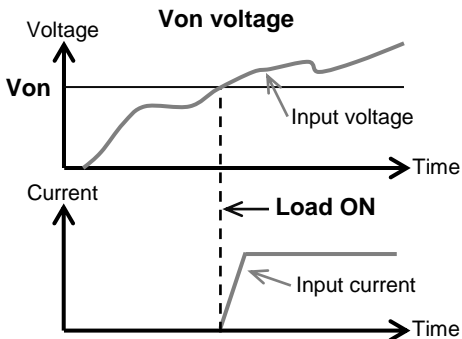

**Operation** Press **Main** > *Configure* [F5] > *Other* [F2] in order, and set the *Von Voltage* level.  
*Von Voltage*: 0.00 ~ rated voltage

### 2-3-2-2. Von Voltage Delay

**Description** Von Delay is the amount of time the unit will wait before turning the load on after the Von Voltage threshold has been latched. This will prevent overshoot current from affecting the Von Voltage threshold.

**Operation** Press **Main** > *Configure* [F5] > *Other* [F2] in order, and set the *Von Delay* time.  
*Von Delay*: OFF, 2.0~60ms (LSG/LSG-H)  
*Von Delay-CR*: OFF, 5.0~60ms (LSG)  
 OFF, 2.0~60ms (LSG-H)

### 2-3-2-3. Von Voltage Latch

Description

When Von Latch is set to OFF, the load will turn off when the voltage drops below the Von Voltage threshold level. When Von Latch is set to ON, the load will continue to sink current after being “latched”, even if the voltage drops below the Von Voltage threshold level. By default Von Latch is set to OFF.

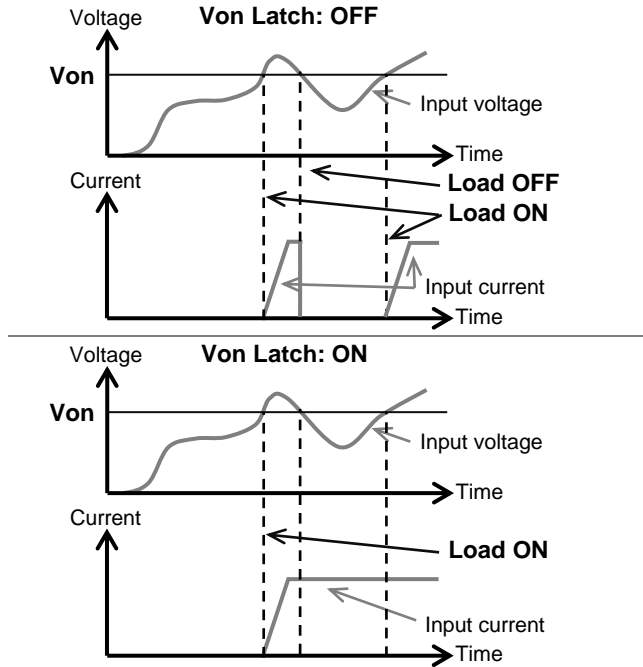

Operation

Press **Main** > *Configure* [F5] > *Other* [F2] in order, and set the *Von Latch* setting.  
Von Latch: OFF, ON

## 2-3-3. Timer Functions

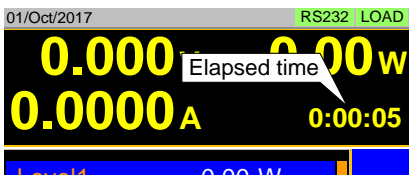

### 2-3-3-1. Count Time

Description	<p>When Count Time timer is set to on, it will count the elapsed time from when the load was turned on to when it was turned off.</p> <p>This function is applicable to manual and automatic shutdown (such as from protection functions such as UVP etc.)</p> <p>The elapsed time will be shown in the display Measurement area.</p>
Operation	<p>Press <b>Main</b> &gt; <i>Configure</i> [F5] &gt; <i>Other</i> [F2] in order, and turn the <i>Count Time</i> on or off.</p> <p>Count Time: ON, OFF</p>
Display	

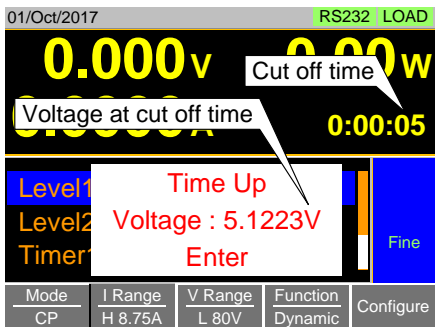
### 2-3-3-2. Cut Off Time

Description	<p>The Cut Off Time function will turn the load off after a set amount of time. After the load has been turned off, a popup screen will LCD display the voltage level when the load was turned off.</p>
Operation	<p>Press <b>Main</b> &gt; <i>Configure</i> [F5] &gt; <i>Other</i> [F2] in order, and set the <i>Cut Off Time</i>.</p> <p>Cut Off Time: OFF, 1 s ~ 999 h 59m 59 s</p>
Display	

## 2-3-4. Auto Load Configuration

Description	The LSG Series can be configured to automatically load program function, normal sequence function, fast sequence function or manual operation at startup. By default, "Auto Load" is OFF and "Auto Load On" is Load.				
Operation	<p style="text-align: center;">Utility</p> <ol style="list-style-type: none"> <li>1. Press  &gt;  &gt; Load [F2] in order.</li> <li>2. Turn <i>Auto Load</i> Off or On. When set to OFF, the Auto Load setting is disabled. Auto Load : OFF, ON</li> <li>3. Select the <i>Auto Load On</i> configuration. This will select whether the LSG Series will automatically load program function, normal sequence function, fast sequence function or manual operation. Auto Load On: <table border="1" style="display: inline-table; vertical-align: middle;"> <tr><td>Load : manual operation</td></tr> <tr><td>Prog : program function</td></tr> <tr><td>NSeq : normal sequence function</td></tr> <tr><td>FSeq : fast sequence function</td></tr> </table> </li> </ol>	Load : manual operation	Prog : program function	NSeq : normal sequence function	FSeq : fast sequence function
Load : manual operation					
Prog : program function					
NSeq : normal sequence function					
FSeq : fast sequence function					

## 2-3-5. Load Off (Mode) and Load Off (Range)

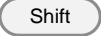
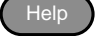
Description	<p>By default the load will automatically turn off when the either the operating mode (CC, CV, CR, CP) or the range (I range, V range) is changed.</p> <p>To allow the load to stay on when the operating mode is changed, set the Load Off (Mode) setting to OFF.</p> <p>To allow the load to stay on when the current or voltage range is changed, set the Load Off (Range) setting to OFF.</p> <p>By default, these settings are set to ON.</p>
Operation	<p style="text-align: center;">Utility</p> <ol style="list-style-type: none"> <li>1. Press  &gt;  &gt; Load [F2] in order.</li> <li>2. Select Load Off (Mode) setting. When set to OFF, the load will stay on when the operating mode is changed. Load Off(Mode): OFF,ON</li> <li>3. Select Load Off (Range) setting. When set to OFF, the load will stay on when the range is changed. Load Off(Range): OFF,ON</li> </ol>

## 2-4. Step Resolution Configuration

There are two different ways (Cursor Mode and Step Mode) to set the resolution when using the scroll wheel to edit parameters.

Step Mode is the default method. Only one mode can be active at a time; when one mode is active, the other mode is deactivated.

### 2-4-1. Cursor Mode Configuration

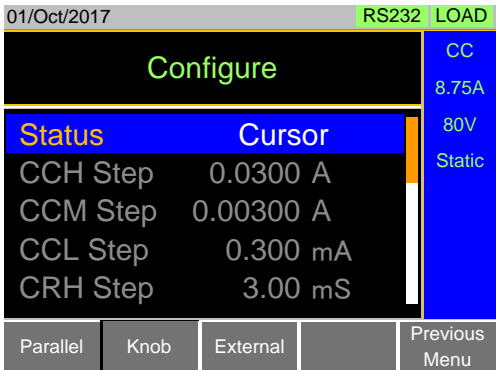
Description	Cursor Mode allows you to edit the selected parameter one digit at a time. When editing a parameter, pressing the scroll wheel determines which digit is selected. Turning the scroll wheel will then edit the parameter by the step resolution of the digit. See the Conventions section on page 30 (Cursor Mode of 1-4-15.Conventions) for operation details.
Operation	Press <b>Main</b> > <i>Configure</i> [F5] > <i>Next Menu</i> [F4] > <i>Knob</i> [F2] in order, and set the <i>Status</i> setting is set to <i>Cursor</i> .
Display	

## 2-4-2. Step Mode Configuration

Description	<p>When set to Step Mode, the voltage, current, resistance and power settings can have the step resolution configured. The step resolution refers to the step resolution of the coarse adjustment for these settings. The fine adjustment cannot be configured. See the Conventions section on page 30 (1-4-15. Conventions_ Step Mode) for details on how to switch between coarse and fine adjustment modes.</p>																								
Settings	<p>The step resolution of each setting is configured separately for each current range.</p> <table border="1" data-bbox="348 467 984 810"> <thead> <tr> <th>Settings</th> <th>Description</th> </tr> </thead> <tbody> <tr> <td>CCH Step</td> <td>CC mode, I Range = High</td> </tr> <tr> <td>CCM Step</td> <td>CC mode, I Range = Middle</td> </tr> <tr> <td>CCL Step</td> <td>CC mode, I Range = Low</td> </tr> <tr> <td>CRH Step</td> <td>CR mode, I Range = High</td> </tr> <tr> <td>CRM Step</td> <td>CR mode, I Range = Middle</td> </tr> <tr> <td>CRL Step</td> <td>CR mode, I Range = Low</td> </tr> <tr> <td>CVH Step</td> <td>CV mode, V Range = High</td> </tr> <tr> <td>CVL Step</td> <td>CV mode, V Range = Low</td> </tr> <tr> <td>CPH Step</td> <td>CP mode, I Range = High</td> </tr> <tr> <td>CPM Step</td> <td>CP mode, I Range = Middle</td> </tr> <tr> <td>CPL Step</td> <td>CP mode, I Range = Low</td> </tr> </tbody> </table>	Settings	Description	CCH Step	CC mode, I Range = High	CCM Step	CC mode, I Range = Middle	CCL Step	CC mode, I Range = Low	CRH Step	CR mode, I Range = High	CRM Step	CR mode, I Range = Middle	CRL Step	CR mode, I Range = Low	CVH Step	CV mode, V Range = High	CVL Step	CV mode, V Range = Low	CPH Step	CP mode, I Range = High	CPM Step	CP mode, I Range = Middle	CPL Step	CP mode, I Range = Low
Settings	Description																								
CCH Step	CC mode, I Range = High																								
CCM Step	CC mode, I Range = Middle																								
CCL Step	CC mode, I Range = Low																								
CRH Step	CR mode, I Range = High																								
CRM Step	CR mode, I Range = Middle																								
CRL Step	CR mode, I Range = Low																								
CVH Step	CV mode, V Range = High																								
CVL Step	CV mode, V Range = Low																								
CPH Step	CP mode, I Range = High																								
CPM Step	CP mode, I Range = Middle																								
CPL Step	CP mode, I Range = Low																								
Operation	<ol style="list-style-type: none"> <li>Press <b>Main</b> &gt; <i>Configure</i> [F5] &gt; <i>Next Menu</i> [F4] &gt; <i>Knob</i> [F2] in order, and set the desired step resolution settings.</li> <li>Set the desired step resolution settings. (The step resolution settings are only available when Status=Step (coarse/fine))</li> </ol> <p>For example if the step resolution for CCM Step is 0.006A, then the resolution can be incremented in 0.006A steps.</p>																								

### Display

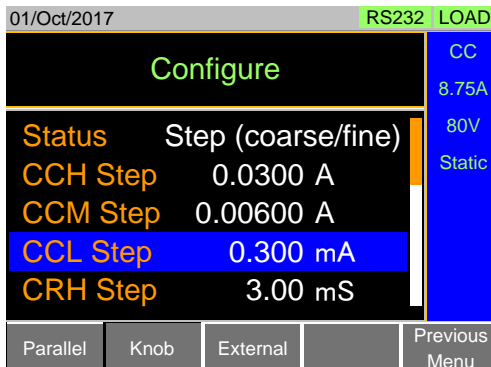

## 2-5. Protection Settings

The Protection settings are used to prevent damage to the unit or the power source by excessive current, voltage or power.

An alarm is generated and a message is displayed on the LCD display when a protection setting is tripped. When an alarm is activated, the load is turned off (or limited), and the ALARM STATUS pin of the J1 on the rear panel (pin 16) turns on (open collector output by a photo coupler). The protection settings can be used regardless of whether the remote sense connections are used or not.

### 2-5-1. OCP

Description	For OCP, the LSG Series can be configured to either limit the current or turn off the load. The OCP levels can be set to 10% higher than the rated current.
Operation	Press <b>Main</b> > <i>Configure</i> [F5] > <i>Protection</i> [F1] in order, and set the OCP Level and OCP Setting. OCP Level: rated current + 10% OCP Setting: LIMIT, Load Off
Alarm	When <i>OCP Setting</i> is configured to <i>Load Off</i> , a message will be displayed on the LCD display when OCP is tripped. The Enter key must be pressed to clear the alarm message. When configured to <i>LIMIT</i> , OCP will be displayed on the LCD display when the OCP is tripped and the current will be limited to the <i>OCP Level</i> setting.

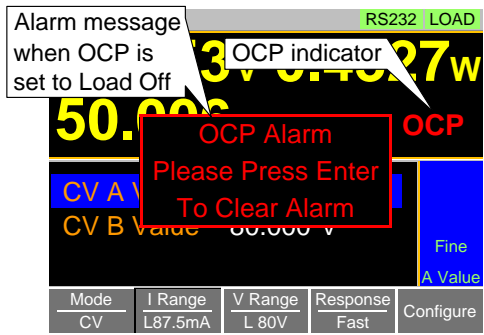
Display	 <p>Alarm message when OCP is set to Load Off</p> <p>OCP indicator</p> <p>50.00</p> <p>CV A</p> <p>CV B</p> <p>Please Press Enter To Clear Alarm</p> <p>OC</p> <p>Mode CV I Range L87.5mA V Range L 80V Response Fast Configure</p>
---------	---

## 2-5-2. OPP

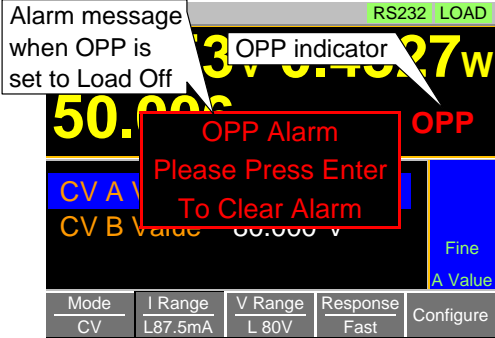
Description	<p>For OPP, the LSG Series can be configured to either limit the power or turn off the load. The OPP levels can be set to 10% higher than the rated power.</p>										
Operation	<p>Press <b>Main</b> &gt; <i>Configure</i> [F5] &gt; <i>Protection</i> [F1] in order, and set the OPP Level and OPP Setting. OPP Level: rated power + 10% OPP Setting: LIMIT, Load Off</p>										
Alarm	<p>When <i>OPP Setting</i> is configured to <i>Load Off</i>, a message will be displayed on the LCD display when OPP is tripped. The Enter key must be pressed to clear the alarm message. When configured to <i>LIMIT</i>, OPP will be displayed on the LCD display when the OPP is tripped and the power will be limited to the <i>OPP Level</i> setting.</p>										
Display	 <p>Alarm message when OPP is set to Load Off</p> <p>OPP indicator</p> <p>OPP Alarm Please Press Enter To Clear Alarm</p> <table border="1" data-bbox="412 938 860 983"> <tr> <td>Mode</td> <td>I Range</td> <td>V Range</td> <td>Response</td> <td>Configure</td> </tr> <tr> <td>CV</td> <td>L87.5mA</td> <td>L 80V</td> <td>Fast</td> <td></td> </tr> </table>	Mode	I Range	V Range	Response	Configure	CV	L87.5mA	L 80V	Fast	
Mode	I Range	V Range	Response	Configure							
CV	L87.5mA	L 80V	Fast								



### 2-5-3. UVP

Description	If the UVP is tripped, the LSG Series will turn off the load. The UVP levels can be set from 0V to 10% higher than the rated voltage.
Operation	Press <b>Main</b> > <i>Configure</i> [F5] > <i>Protection</i> [F1] in order, and set the UVP Level. UVP Level: OFF, 0~ rated voltage + 10%
Alarm	The UVP indicator will only appear on the LCD display when the input voltage is below the UVP level. Pressing the Enter key will clear the message. The UVP indicator will remain on the display until the voltage level rises back above the UVP level.

Display

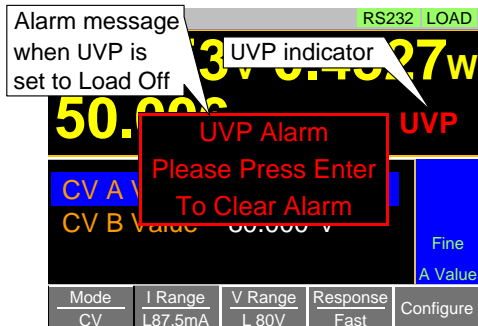

Alarm message when UVP is set to Load Off

UVP indicator

UVP Alarm  
Please Press Enter  
To Clear Alarm

Mode	I Range	V Range	Response	Configure
CV	L87.5mA	L 80V	Fast	Configure

## 2-5-4. UVP Ring Time

Description	<p>The UVP Ring Time settings allows the UVP alarm to keep sounding for a user-set amount of time after the UVP has been tripped.</p> <p>The alarm will continue ringing for the set amount of time even if the voltage rises back above the UVP level~ unless the alarm is cleared manually.</p>
Operation	<p>Press <b>Main</b> &gt; <i>Configure</i> [F5] &gt; <i>Protection</i> [F1] in order, and set the <i>UVP Ring Time</i>.</p> <p>UVP Ring Time: OFF, 1~600s,Infinity</p>
Alarm	<p>When the voltage dips below the UVP level, the UVP indicator and message will appear on the LCD display. The UVP buzzer will sound if UVP Ring Time is set.</p> <p>Under this scenario the following outcomes are possible:</p> <p>Pressing the Enter key will clear the message and the buzzer. The UVP indicator will remain on the display until the voltage level rises back above the UVP level.</p> <p>If the UVP Ring Time is allowed to elapse, the buzzer will stop. However the UVP indicator and message will remain on screen until the voltage increases and the message is cleared.</p> <p>If the voltage rises back above the UVP level, the UVP indicator will be cleared from the display, but the buzzer will continue to sound until the UVP Ring Time has elapsed and the message will remain until it has been cleared.</p>

Display	<p>Alarm message when UVP is set to Load Off</p> <p>UVP indicator</p> <p>UVP Alarm Please Press Enter To Clear Alarm</p> <p>UVP</p> <table border="1"> <thead> <tr> <th>Mode</th> <th>I Range</th> <th>V Range</th> <th>Response</th> <th>Configure</th> </tr> </thead> <tbody> <tr> <td>CV</td> <td>L87.5mA</td> <td>L 80V</td> <td>Fast</td> <td></td> </tr> </tbody> </table>	Mode	I Range	V Range	Response	Configure	CV	L87.5mA	L 80V	Fast	
Mode	I Range	V Range	Response	Configure							
CV	L87.5mA	L 80V	Fast								

## 2-5-5. OVP

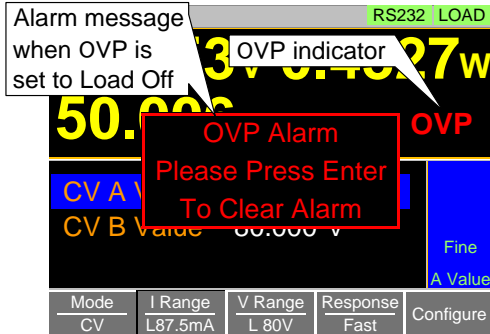
Description	If the OVP is tripped, the LSG Series will turn off the load. The OVP levels can be set from 0V to 10% higher than the rated voltage.
Operation	<p>Press <b>Main</b> &gt; <i>Configure</i> [F5] &gt; <i>Protection</i> [F1] in order, and set the OVP Level.</p> <p>OVP Level: OFF, 0~ rated voltage + 10%</p> <p>Note: To turn OVP off, set the OVP voltage greater than the current rating voltage + 10%.</p>
Alarm	<p>The OVP indicator and a message will only appear on the LCD display when the input voltage is below the OVP level.</p> <p>Pressing the Enter key will clear the message.</p> <p>The OVP indicator will remain on the display until the voltage level falls back above the OVP level.</p> <p>Note: Please use the input voltage to the LSG Series in 80V or less.</p>
Display	

## 2-5-6. UnReg

Description	The UnReg error message will appear on the LCD display when the electronic load is operating in an unregulated state.
Alarm	The UnReg indicator will appear on the LCD display when the set load is inadequate for the power source. To clear the UnReg indicator, increase the current of power source or reduce the load requirements.

Display

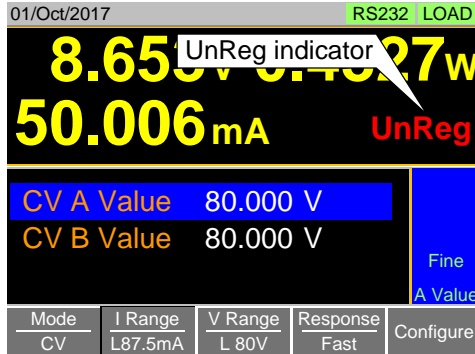

## 2-5-7. Para

Description	The Para error message will appear on the LCD display when the LSG/LSG-H is used in parallel and if an error is produced.
Alarm	The Para error message indicates one of the following possible conditions: UnReg, R.OCP, OTP. To clear the Para indicator, remove the cause of the alarm.

Display

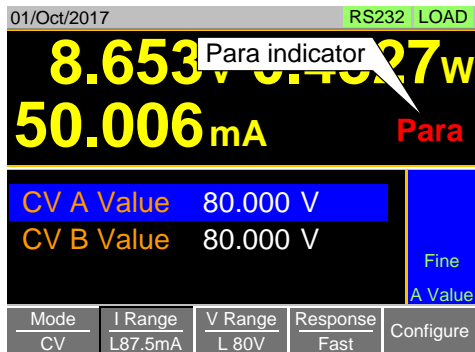

## 2-5-8. RVP

---

Description	If the RVP is tripped, the LSG Series will turn off the load.
Alarm	The RVP error message indicates when the terminal voltage is negative. The Enter key must be pressed to clear the alarm message.

---

Display

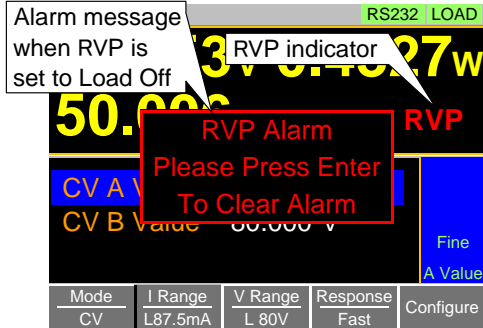



## 2-6. System Settings

The following section covers a number of miscellaneous system settings such as:

- Input control settings
- Sound settings
- Alarm tone settings
- Display settings
- Language settings
- Input/output trigger setting



All system settings are accessible in the Utility menu.

### 2-6-1. Input control settings

Description	The Knob Type setting determines if values are updated immediately as they are edited or if they are only updated after the Enter key is pressed. The <i>Updated</i> setting is applicable for when the load is already on and the user wishes to change the set values (current, voltage, etc.) in real time. The <i>Old</i> setting is will only update the values after the Enter key is pressed.
Operation	<p style="text-align: right;">Utility</p> Press  >  > <i>Other</i> [F5] in order, and set the Knob type. Knob type: Updated, Old



### 2-6-2. Sound Settings

#### 2-6-2-1. Speaker Settings

Description	Turns the speaker sound on or off for the user interface, such as key press tones and scrolling tones.
Operation	<p style="text-align: right;">Utility</p> Press  >  > <i>Other</i> [F5] in order, and set the Speaker settings on or off. Speaker: ON, OFF Note: When set to OFF, the speaker setting will not disable the tones for Go-NoGo or protection alarms.

## 2-6-2-2. Alarm Tone Settings

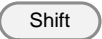
---

Description	The alarm tone for the unit can be turned on or off in the utility menu. The alarm tone can be set separately. Alarm Tone: alarm of the protection (OCP, OPP, UVP, and OVP) settings. UnReg Tone: alarm of operating in an unregulated state. Go-NoGo Tone: alarm of Go-NoGo testing.
Operation	<p style="text-align: center;">Utility</p> Press  >  > <i>Other</i> [F5] in order, and set the alarm tone settings on or off. Alarm Tone: ON, OFF UnReg Tone: ON, OFF Go_NoGo Tone: ON, OFF



---

Note: The Alarm tone and Go\_NoGo Tone settings ignore the *Speaker* setting.

---

## 2-6-3. Display Settings

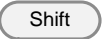

---

Description	Sets the contrast level for LCD display.
Operation	<p style="text-align: center;">Utility</p> Press  >  > <i>Other</i> [F5] in order, and set the <i>Contrast</i> and <i>Brightness</i> settings. Contrast: 3 ~ 13 (low ~ high) Brightness: 50 ~ 90 (low ~ high)

---

## 2-6-4. Language Settings

---



Description	The LSG Series supports only English.
Operation	<p style="text-align: center;">Utility</p> Press  >  > <i>Other</i> [F5] in order, and set the <i>Language</i> setting. Supported languages: English

---

## 2-6-5. Input / Output Trigger Settings

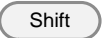

### 2-6-5-1. Trigger in Delay

---

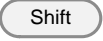

Description	The Trig in Delay setting determines how long to delay any action after a trigger is received. Default setting 0.01ms
Operation	<p style="text-align: center;">Utility</p> Press  >  > <i>Other</i> [F5] in order, and set the Trig in Delay setting. Trig in Delay: 0.01~100ms

---

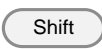

## 2-6-5-2. Trigger Out Width

Description	The Trigger Out Width setting sets the trigger output signal's pulse width. Default setting 10.0us
Operation	Press  >  > <i>Other</i> [F5] in order, and set the Trig Out width. Trig Out width: 2.5– 5000us

## 2-6-6. Measure Average

Description	The Measure Average setting is used to set the speed of the measurement display. The setting has three modes. They are slow, normal and fast The default mode for Measure Average setting is slow.
Operation	1. Press  +  > <i>Other</i> [F5]. 2. Set the <i>Measure Average</i> setting. Slow Average 1024 times Normal Average 64 times Fast Average 4 times Default Slow mode

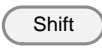
## 2-6-7. VP Load Off

Description	When the input terminal detects reverse voltage, a warning message will be displayed and the RVP Load Off setting can be set to turn on or off the load as well. The setting has two modes. They are ON and OFF. The default mode for RVP Load Off setting is ON.
Operation	1. Press  +  > <i>Other</i> [F5]. 2. Set the <i>Load Off</i> setting. ON When the input terminal detects the reverse voltage, a warning message will be displayed on the screen and the load will be turned off. OFF When the input terminal detects the reverse voltage, a warning message will be displayed on the screen but the load will not be turned off.



## 2-7. Go-NoGo

The Go-NoGo configuration is used to create pass/fail limits on the voltage or current input. If the voltage/current exceeds the pass/fail limits, an alarm will be output.

The Go-NoGo configuration can be used with the program operation to create complex pass/fail tests.

### 2-7-1. Setting the Go-NoGo Limits

Description	<p>The Go-NoGo setting limits can be set as either discrete high &amp; low values or as a percentage offset from a center value. The limit level of the CC, CR and CP mode become the voltage level. The limit level of the CV mode becomes the current level. The set range of the limit level of the voltage/ current is rated voltage/ current of the voltage/ current range H.</p>
Operation	<ol style="list-style-type: none"> <li>1. Press  &gt; <i>Configure</i> [F5] &gt; <i>Go-NoGo</i> [F3] in order.</li> <li>2. Select <i>Entry Mode</i> and choose how to set the pass/fail limits. Value will allow you to set the limits as discrete values. Percent will allow you to set the limits as a percentage offset from a center value.</li> <li>3. If <i>Entry Mode</i> was set to <i>Value</i>, Set the <i>High &amp; Low</i> limit values. High: 0~ rated current/voltage Low: 0 ~ rated current/voltage</li> <li>4. If <i>Entry Mode</i> was set to <i>Percent</i>, Set the <i>Center</i> voltage/current and <i>High, Low %</i> values. Center: 0~ rated current/voltage High: Center + 0~100% of Center current/voltage Low: Center - 0~100% of Center current/voltage</li> <li>5. Set the <i>Delay Time</i>. The delay time setting will delay activating the Go-NoGo testing by a specified amount of time. The delay setting can compensate for startup oscillation and other instabilities during startup. Delay Time 0.0~1.0 seconds (0.1s resolution )</li> </ol>



Note

When the Main settings are saved or recalled, the Go-NoGo settings are also saved / recalled. See the Save/Recall chapter for details, page 71 (2-8. Save / Recall).

## 2-7-2. Running a Go-NoGo Test

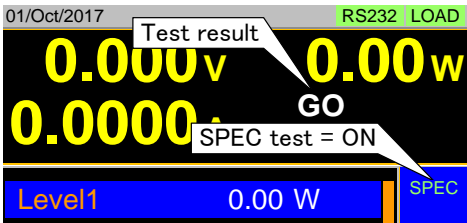
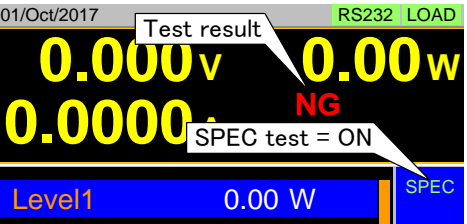
Description	Go-NoGo test results are displayed in the measurement panel of LCD display. GO indicates pass (good). NG indicates fail (no good).
Operation	<ol style="list-style-type: none"><li>1. Press <b>Main</b> &gt; <i>Configure</i> [F5] &gt; <i>Go-NoGo</i> [F3] in order.</li><li>2. Set <i>SPEC Test</i> to ON. When <i>SPEC Test</i> is ON, <i>SPEC</i> will appear in the operation status panel of LCD display. This means the unit is ready for Go-NoGo testing.</li><li>3. Turn the load on. The test starts from the time the load was turned on + the Delay Time.</li></ol>
Display: GO	 <p>The LCD display shows the date '01/Oct/2017' and 'RS232 LOAD' in the top right. The main display area shows '0.000V' and '0.000.' in large yellow digits. To the right, '0.00w' is displayed in yellow. In the center, 'GO' is shown in large yellow letters. Below this, 'SPEC test = ON' is displayed in white. At the bottom, a blue bar contains 'Level1' in white, '0.00 W' in white, and 'SPEC' in white on the right side. A callout box labeled 'Test result' points to the 'GO' text.</p>
Display: NG	 <p>The LCD display shows the date '01/Oct/2017' and 'RS232 LOAD' in the top right. The main display area shows '0.000V' and '0.000.' in large yellow digits. To the right, '0.00w' is displayed in yellow. In the center, 'NG' is shown in large red letters. Below this, 'SPEC test = ON' is displayed in white. At the bottom, a blue bar contains 'Level1' in white, '0.00 W' in white, and 'SPEC' in white on the right side. A callout box labeled 'Test result' points to the 'NG' text.</p>

## 2-8. Save / Recall

The LSG Series can save and recall system settings, preset data, memory data, Go-NoGo settings as well as normal and fast sequences to internal memory or to USB.

### 2-8-1. File Structure

---

Description	<p>The LSG Series file system can save files to internal memory (Media   Memory) and external memory (Media   USB).</p> <p>To save or recall Memory, Setup or Preset data, the LSG Series uses a three tier system where files are saved or recalled in the following order: Active settings &lt;-&gt; Internal memory &lt;-&gt; USB. This can be best described in the picture below.</p>
-------------	--

---

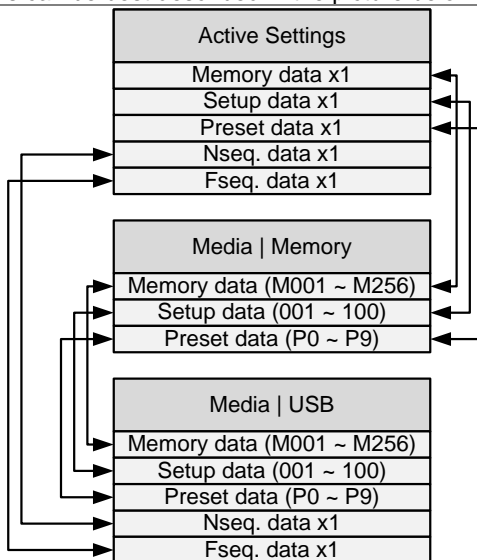

For example:

To load Preset Data P7 from USB, you must first load Preset Data P0~P9 to internal memory, then from internal memory load Preset P7 to be the active preset setting. For normal and fast sequences however, files can be saved or recalled directly to/from USB memory.

---

## 2-8-2. File Types

Memory Data	Memory data contains general settings and is used for creating programs. Memory Data contains the operating mode, range, response and Go/NoGo settings. Memory data can be stored both internally and externally to USB. Preset data and Memory data store the same contents.
	Internal Format      M001 ~ M256
	External Format      model no_file no.M example: 1050H_01.M
Setup Data	Setup data contains all general configuration settings, protection settings; program and program chain settings, as well as parallel configuration settings.
	Internal Format      1 ~ 100
	External Format      model no_file no.S example: 1050H_00.S
Preset Data	Preset Data contains the same settings as the Memory Data. Preset Data contains the operating mode, range, response and Go-NoGo settings.
	Internal Format      P0 ~ P9
	External Format      model no_file no.P example: 1050H_00.P
NSeq Data	NSeq Data contains the Normal Sequence settings.
	Internal Format      None
	External Format      model no_file no.N example: 1050H_00.N
FSeq Data	FSeq Data contains the Fast Sequence settings.
	Internal Format      None
	External Format      model no_file no.F example: 1050H_00.F

## 2-8-3. Saving Files to Internal Memory

**Description** When saving Memory, Setup or Preset Data to internal memory, the currently active setting is saved to one of the internal memory slots. Memory Data has 256 memory slots, Setup Data has 100 memory slots and Preset Data has 10 memory slots.

**Memory Data Example**

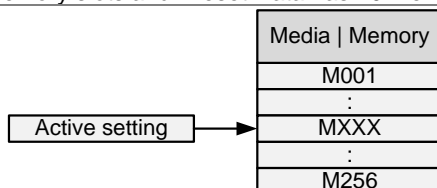

**Display**

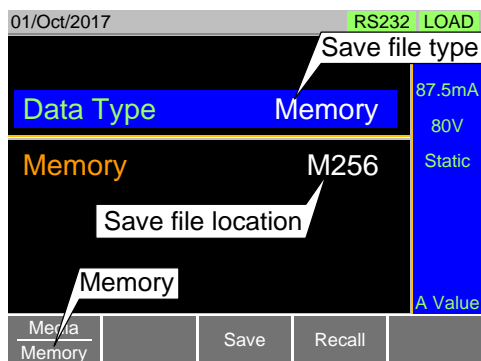

**Operation**

1. Press **Shift** > **File** (**FUNC**) in order.
2. Select **Memory** with the **Media** [F1] soft-key.
3. Select the **Data Type** and choose the type of file to save.  
Data Type: Memory Data,  
Setup Data,  
Preset Data
4. Select which internal memory location to save the file.  
Memory: M001 ~ M256  
Setup Memory: 1 ~ 100  
Preset: P0 ~ P9
5. Press **Save** [F3] to save.  
Save Ok will be displayed when the save has been completed.



**Note**

Normal Sequence and Fast Sequence data cannot be recalled from or saved to an internal memory slot.

## 2-8-4. Saving Files to USB Memory

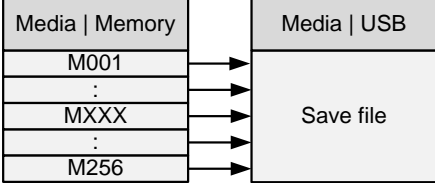
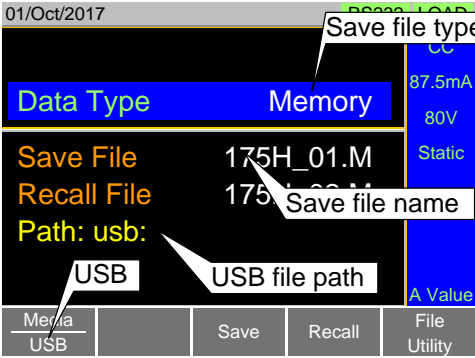
Description	When saving files to USB memory, all the memory locations from the selected data type are saved as a single file to the USB file path directory.
Memory Data Example	 <p>The diagram shows a list of memory locations on the left: M001, followed by a vertical ellipsis, MXXX, followed by another vertical ellipsis, and M256. Arrows from each of these entries point to a single box on the right labeled 'Save file'. Above this box is a header 'Media   USB'.</p> <p>For example, Memory Data M001 to M256 is saved to a single file on USB.</p>
Display	 <p>The screenshot shows a device display with a dark background. At the top, it shows the date '01/Oct/2017'. Below that, there's a menu with 'Data Type' and 'Memory' highlighted in blue. Underneath, 'Save File' is highlighted in orange, with '175H_01.M' next to it. Below that, 'Recall File' is highlighted in orange, with '175H_01.M' next to it. At the bottom, 'Path: usb:' is highlighted in yellow. Callouts point to 'Save file type' (pointing to 'Memory'), 'Save file name' (pointing to '175H_01.M'), and 'USB file path' (pointing to 'usb:'). On the right side, there are various status indicators like '87.5mA', '80V', 'Static', and 'A Value'. At the bottom, there are buttons for 'Media/USB', 'Save', 'Recall', and 'File Utility'.</p>
Operation (1/2)	<ol style="list-style-type: none"> <li>1. Insert a USB drive into the USB port.</li> <li>2. Press <b>Shift</b> &gt; <b>FUNC</b> in order.</li> <li>3. Select USB with the <i>Media</i> [F1] soft-key.</li> <li>4. Select the <i>Data Type</i> and choose the type of file to save. Data Type: Memory Data, Setup Data, Preset Data, NSeq, FSeq</li> <li>5. Select <i>Save File</i> and choose a save filename. Turn the scroll wheel to increase/decrease the file number. Memory: Model_file number.M Setup Memory: Model_file number.S Preset: Model_file number.P NSeq: Model_file number.N FSeq: Model_file number.F</li> </ol>

Operation (2/2)	6. Press <b>Save [F3]</b> to save. The file will be saved to the USB file path. <b>Save Ok</b> will be displayed when the save has been completed. If saving-over an existing file you will be asked to confirm the save. Press the <b>Save[F3]</b> key to confirm.
File Utilities	Press <b>File Utility [F5]</b> to access the file utility. See page 78 (2-8-8. File Utility) for details. Change the USB path. Rename files or create directories.

### 2-8-5. Recalling Files from Internal Memory

Description	When recalling Memory, Setup or Preset Data from the internal memory slots, the recalled file becomes the active setting. Memory Data has 256 memory slots, Setup Data has 100 memory slots and Preset Data has 10 memory slots.
-------------	---

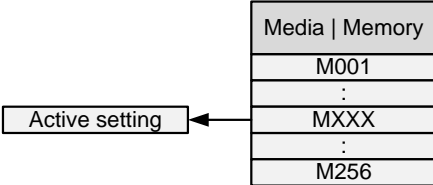
Memory Data Example	
---------------------	---

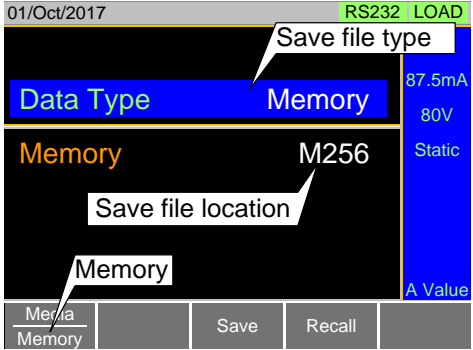
Display	
---------	--

---

## Operation

1. Press **Shift** > **File** **FUNC** in order.
  2. Select *Memory* with the *Media* [F1] soft-key.
  3. Select the *Data Type* and choose the type of file to recall.  
Data Type: Memory Data, Setup Data, Preset Data
  4. Select which memory slot to recall from.  
Memory: M001 ~ M256  
Setup Memory: 1 ~ 100  
Preset: P0 ~ P9
  5. Press *Recall* [F4] to recall.  
For Memory Data and Preset Data, a popup window will appear. Press the **Enter** key to confirm the recall.
- 



Note

Normal Sequence and Fast Sequence data cannot be recalled from or saved to an internal memory slot. They can, however, be recalled directly from USB memory. See the next section below for details.

---

## 2-8-6. Recalling Files from USB Memory

### Description

When recalling Memory, Setup or Preset files from USB memory, a single file from the USB drive will overwrite all the existing memory slots for the selected data type. For Normal or Fast Sequence files, the recalled file becomes the active setting as these types of files don't have an internal memory slot.

---



Caution

You can only recall files from the same model.

---

### Memory Data Example

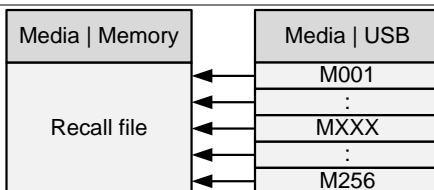

For example, if the file 175H\_01.M is recalled, all the Memory Data from M001 to M256 will be overwritten.

---



---

Display

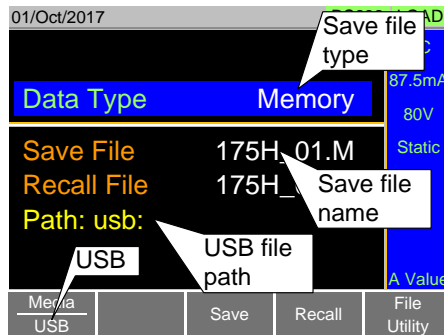

---

Operation

1. Insert a USB drive into the USB port.
2. Press **Shift** > **FUNC** in order.
3. Select **USB** with the *Media* [F1] soft-key.
4. Select the *Data Type* and choose the type of file to recall.  
Data Type: Memory Data, Setup Data, Preset Data, NSeq, FSeq
5. Select *Recall File* and choose a filename.  
Turn the scroll wheel to increase/decrease the file number.  
Memory: Model\_file number.M  
Setup Memory: Model\_file number.S  
Preset: Model\_file number.P  
NSeq: Model\_file number.N  
FSeq: Model\_file number.F
6. Press *Recall* [F4] to recall.  
Recall Ok will be displayed when the recall has been completed.

---

File Utilities

Press *File Utility* [F5] to access the file utility. See page 78 (2-8-8. File Utility) for details.  
Change the USB path.  
Rename files or create directories.



Caution

If "Machine Type Error" is displayed it indicates that the file that you are trying to recall originated from a different model. You can only recall files from the same model.

---

## 2-8-7. Recall Memory Safety Setting

Description	By default when you try to recall a file or setting from memory, a message will appear asking you to press the Enter key to confirm. This is the standard safety measure to ensure that the wrong file/setting is not recalled. This safety measure can be disabled by setting the Mem. Recall setting to "Direct".
Operation	Press <b>Main</b> > <i>Configure</i> [F5] > <i>Other</i> [F2] in order, and set the <i>Mem. Recall</i> setting. Mem. Recall: Safety, Direct
 Note	This setting only applies when recalling preset settings from internal memory, either by using the Presets keys (P0 - P9) or by using the File menu. Preset keys: See page 79 (2-8-9-2.Quick Preset Recall). File menu: See page 75 (2-8-5.Recalling Files from Internal Memory).

## 2-8-8. File Utility

Description	The file utility allows you to create new folders, rename files and set the USB path directory. It is only available for use with the USB external memory.
Operation	1. Insert a USB drive into the USB port. 2. Press <b>Shift</b> > <b>FUNC</b> > <i>File Utility</i> [F5] in order, the file utilities screen appears.

Display

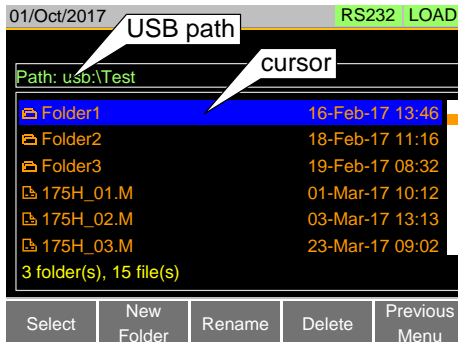

Create a new Folder	Press <i>New Folder</i> [F2] to create a new folder. Use the on-screen display to enter the filename. A maximum of 8 characters.
Rename a Folder	1. Use the scroll wheel to move the cursor to the file/folder you wish to rename.

	2. Press <i>Rename</i> [F3]. Use the on-screen display to enter the filename. A maximum of 8 characters.
Delete File or Folder	1. Use the scroll wheel to move the cursor to the file/folder you wish to delete.
	2. Press <i>Delete</i> [F4].
	3. Press <i>Delete</i> [F4] again to confirm the deletion.

## 2-8-9. Preset

The Preset key is used to save and recall preset settings from the front panel quickly. The presets have the same contents as memory data; this includes the operating mode, range, configuration settings and Go-NoGo settings.

### 2-8-9-1. Quick Preset Save



Description	The current settings can be saved to P0 ~ P9 using the Preset key and the number pad.
Operation	1. Press <b>Preset</b> .
	2. Pressing <sup>P0</sup> 0 ~ <sup>P9</sup> 9 until a beep is heard. The beep indicates that the setting was saved to the selected preset.

### 2-8-9-2. Quick Preset Recall





Description	Presets P0 to P9 can be recalled quickly by using the Preset key and the number pad.
Operation	1. Press <b>Preset</b> .
	2. Press <sup>P0</sup> 0 ~ <sup>P9</sup> 9.
	3. Press <b>Enter</b> to confirm the recall when a popup window appears.
	4. Press <b>Preset</b> again to deactivate the preset key.

## 2-8-10. Default Settings

### 2-8-10-1. Factory Default Settings

Description	The factory default settings can be recalled at any time. See page 174 (7-3. LSG Series Default Settings) for a list of the factory default settings.
Operation	<p style="text-align: center;">File</p> <ol style="list-style-type: none"><li>1. Press  &gt;  in order.</li><li>2. Select <i>Default</i> with the <i>Media</i> [F1] soft-key.</li><li>3. Press <i>Factory Default</i> [F2].</li><li>4. Press <i>Factory Default</i> [F2] again to confirm.</li></ol>

### 2-8-10-2. User's Default Setting

Description	The currently active settings can be set as the "User's Default" settings.
Save User's Default Setting	<p style="text-align: center;">File</p> <ol style="list-style-type: none"><li>1. Press  &gt;  in order.</li><li>2. Select <i>Default</i> with the <i>Media</i> [F1] soft-key.</li><li>3. Press <i>Save</i> [F3]. The User's Default is saved immediately.</li></ol>
Recall User's Default Setting	<p style="text-align: center;">File</p> <ol style="list-style-type: none"><li>1. Press  &gt;  in order.</li><li>2. Select <i>Default</i> with the <i>Media</i> [F1] soft-key.</li><li>3. Press <i>Recall</i> [F4].</li><li>4. Press <i>Recall</i> [F4] again to confirm. The User's Default must be saved first before it can be recalled.</li></ol>

### 3. Function MENU

#### 3-1. Function Menu Overview

The Function menu can be used as a quick access hub to the Program, Normal Sequence, Fast Sequence, OCP Test, OPP Test or BATT Test function.

It is also used to set Function specific settings:

Function Select. Complete Ring Time. NSEQ Timer.

#### 3-1-1. Select a Function

Description	<p>The Function Select option is used to turn a Program, Normal Sequence, Fast Sequence, some Test function (OCP, OPP and BATT) or off. Before one of these functions is turned on, they should be configured beforehand. Program, Sequences, OCP Test function, respectively.</p> <p>Refer to the following for those functions.          Program: page 85 (3-2.Program function )          Sequence: page 91 (3-3.Sequence function)          OCP Test function: page 106 (3-4.OCP Test function )          OPP Test function: page 113 (3-5. OPP Test function )          BATT Test function: page 120 (3-6. BATT Test function )          MPPT function page127 (3-7.MPPT function)</p>
Operation	<ol style="list-style-type: none"> <li>1. Press <b>FUNC</b>.</li> <li>2. Select Function Select and choose a function to turn on or choose to turn off the last function.</li> </ol> <p>Function Select:      OFF,                      OCP                                        PROG,                      OPP                                        NSEQ,                     BATT                                        FSEQ,                     MPPT</p>

Function Select Screen	
------------------------	--



Note

After a function is selected, it is then “turned on”.





PROG , NSEQ , FSEQ , OCP , OPP , BATT . MPPT will appear at the top of the LCD display when the selected function is on.

When in the Main menu, the PROG, NSEQ, FSEQ or OCP icon will appear prominently on the LCD display to remind the operator that a function is still on. The manual operation cannot be turned on when a Function mode is turned on.

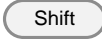

Be sure to turn the selected function off to return to The manual operation.

### 3-1-2. Turning on the Load with the Selected Function

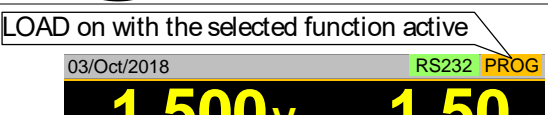

Description	When a function is turned on, the load can be turned on (with the selected function) by pressing Shift + Load.
Operation	<ol style="list-style-type: none"> <li data-bbox="356 778 954 837">1. Select the function (PROG, NSEQ, FSEQ, OCP, OPP or BATT).</li> <li data-bbox="356 837 954 1037">2. Press  &gt;  in order. The  key will turn orange when the load is “on”. The function icon (PROG , NSEQ , FSEQ, OCP, OPP or BATT) turns orange when the load is turned on.</li> <li data-bbox="356 1037 954 1093">3. Press  . The load can be turned off.</li> </ol>
Display	



Note

The selected function will need to be turned off before a “manual operation” can be performed.

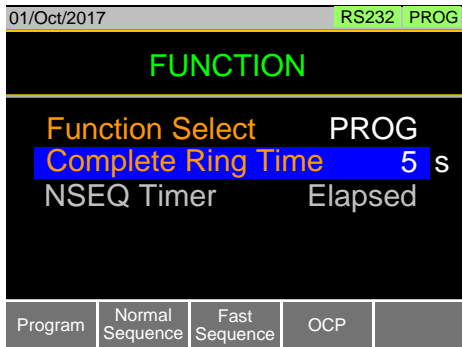
### 3-1-3. Complete Ring Time

Description	The Complete Ring Time function turns the alarm on for a user-set amount of time after a program, sequence or OCP Test function has finished.
Operation	<ol style="list-style-type: none"><li>1. Press <b>FUNC</b>.</li><li>2. Select <i>Complete Ring Time</i> and select how long the alarm should ring after a function has completed. The Complete Ring Time setting applies to all the functions. Complete Ring Time: OFF (Default), 1 – 600s, Infinity</li></ol>
Function Select Screen	
 Note	The alarm may not sound if Alarm Tone is turned off (see page 67).

### 3-1-4. NSEQ Timer

Description	The NSEQ Timer setting determines whether the timer for the Normal Sequence function displays the elapsed time or the remaining time for both the current step and the overall test time for the sequence.
Operation	<ol style="list-style-type: none"> <li>1. Press <b>FUNC</b>.</li> <li>2. Select <b>NSEQ Timer</b> and select whether the current step and total test time is displayed as elapsed time or remaining time.            NSEQ Timer    Elapsed (Default ),                              Remaining</li> </ol>

Function Select Screen

Display example

 **Note** When the total test time is >1000 hours, then the total test time will always be displayed as the elapsed time.



## 3-2. Program function

The LSG Series can create programs that are designed to step-through up to 16 pre-set load operations. The program function is a powerful tool that can allow you to perform a number of different operations in succession.

The execution time of each step is user-defined.

Programs can be chained together to make larger programs.

Up to 16 programs can be created for a program chain.

See page 71 for saving load operations (2-8.Save / Recall).

### 3-2-1. Program function Overview

---

Description	<p>When you run a program, you are essentially executing up to 16 different load operations consecutively. Each of the different load operations are “steps” in the program. A program starts at step 01 and ends at step 16.</p> <p>A program recalls the operating mode, range, static/dynamic mode, response speed and other settings of each step from stored memory. It also recalls the Go-NoGo settings.</p> <p>The same memory settings can be used for multiple steps.</p> <p>The execution time of each step is configurable.</p> <p>Applies the Go-NoGo settings for each step.</p> <p>Each step must be executed in order.</p> <p>Each step can be configured to automatically go to the next step or wait for confirmation from the user before proceeding to the next step.</p> <p>Individual steps can be skipped.</p> <p>Programs can be linked together to make program chains.</p> <p>Program chains need not be executed in order.</p> <p>There are 16 steps to a program.</p> <p>There are up to 16 programs to a chain.</p>
-------------	--

---

Illustration

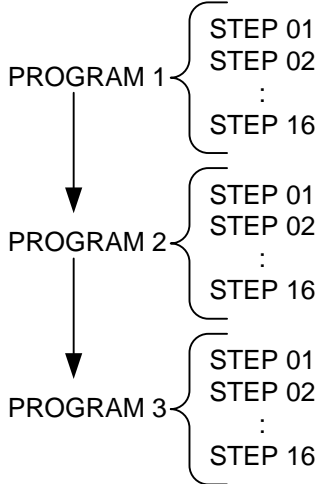

Setting Overview	A program contains the following settings for each step:
Memory:	The memory location of the load operation for the selected step (M001~M256).
Run:	Designates the run setting for the step (Auto, Manual, Skip).
On-Time:	Sets the On-time of the Step test time.
Off-Time:	Sets the Off-time of the Step test time.
P/F-Time:	Sets the testing pass/fail delay time for Go-NoGo testing.
Short-Time:	Sets the shorting time for the step, if any.

Below is a timing diagram of a single step in a program.

Timing Diagram for Single Step

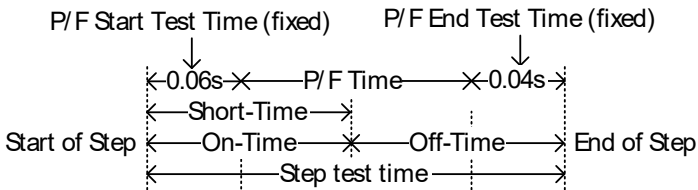

## 3-2-2. Create a Program



Note

Before creating a program, it is necessary to set load operation in internal memory (M001 - M256) to use for each step, and to save it. See the save recall chapter for further details, page 71 (2-8. Save / Recall).

Program Setting  
Display Overview

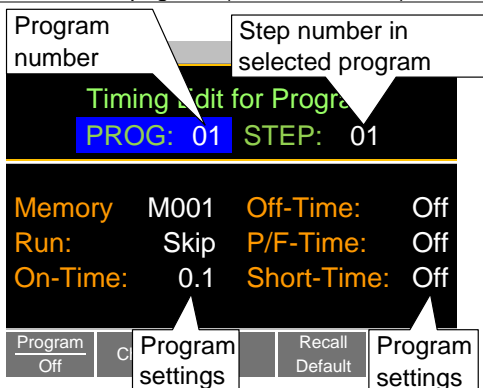

Operation  
(1/2)

1. Press **FUNC**.  
Note: *Program* [F1] is off by default.
2. Select *PROG* and select a program number to edit.  
PROG: 01 ~ 16
3. Select a *STEP* in the selected program.  
STEP: 01 ~ 16
4. Select *Memory* and select which memory location to load for the selected step.  
Settings loaded from the memory location will be used for the selected step.  
The same memory location can be used for multiple steps.  
Memory: M001 ~ M256
5. Set the Run setting for the step.  
By default RUN is set to Skip.  
The Auto setting will automatically start and go onto the next step.  
The Manual setting will wait for the user to press *Next* [F2] before running the step.  
Run: Skip, Auto, Manual

Operation  
(2/2)

- 
6. Choose the *On-Time* in seconds.  
The on-time setting determines how long the load is turned on for the selected step.  
The on-time is defined as the total test time minus the off-time.  
On-Time: 0.1 ~ 60 seconds
- 
7. Choose the *Off-Time* in seconds.  
The off-time setting determines how long the load is turned off between the end of the current step and the start of the next step.  
The off-time is defined as the total test time minus the on-time.  
Off-Time: Off, 0.1 ~ 60 seconds
- 
8. Choose the *P/F-Time* (pass/fail time) in seconds.  
The P/F-Time refers to the P/F delay time. This delay time includes the 0.06 P/F start test time, as shown in the timing diagram on page 86.  
P/F-Time: Off, 0.0 ~ 119.9 seconds
- 
9. Set the *Short-Time* in seconds.  
Has the same action as pressing the short key. See page 42 (2-1-10. Short Key Configuration) for details about shorting the load.  
Short-Time: Off, 0.1 seconds ~ On-Time
- 
10. Repeat steps 3 to 9 for all the steps in the program.  
A maximum of 16 steps per program can be created.  
Steps that are not configured are set to "Skip" by default.
- 
11. Save [F3] to save the program and all the steps in the program.  
The program will be saved to internal memory.  
See the Save/Recall chapter on details on how to save to Setup memory.
- 

Recall Default

Pressing *Recall Default* [F4] will recall the default settings for each program/step. See page 174 (7-3. LSG Series Default Settings) for details.

---

### 3-2-3. Create a Program Chain



Note

Before creating a program chain, make sure a number of programs have already been saved. These will be used to create the program chain.

Chain Setting  
Display Overview

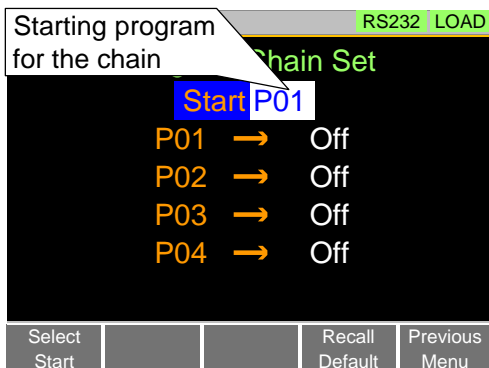

Operation

1. Press **FUNC** > *Program* [F1] > *Chain* [F2] in order. If they were not created in the current session, it may be necessary to load the programs from Setup memory.
2. Press *Select Start* [F1] and select which program will be used to start the program chain.  
Start: P01 ~ P16
3. Select *P01* and choose which program will be linked to P01.  
Selecting OFF will end the chain after P01.  
Selecting P01 will create an infinite chain.  
Chains need not be linked in sequential order.  
P01: OFF, P01 ~ P16
4. Repeat step 3 for any remaining programs in the chain.
5. Press *Save* to save the program chain to internal memory.

Pressing *Recall Default* [F4] will reset the chain to the default settings. See page 174 (7-3. LSG Series Default Settings) for details.

*Recall Default* [F4] will essentially clear the program chain.

### 3-2-4. Running the Program function

Description	Turn the road on, the program function is running.
Operation	<ol style="list-style-type: none"> <li>1. Press <b>FUNC</b> &gt; <i>Program</i> [F1] in order.</li> <li>2. Turn program mode on by setting <i>Program</i> [F1] to on. <b>PROG</b> will appear at the top of the LCD display when <i>Program</i> is On.</li> <li>3. Turn the load on. See page 82 (3-1-2.Turning on the Load with the Selected Function) for the load on. The <b>PROG</b> icon turns orange when the load is turned on.</li> <li>4. When a program is running the screen displays which program, step and memory is currently active. Press <i>Pause</i> [F1] to suspend a test, press <i>Continue</i> [F1] to resume. Press <i>Next</i> [F2] to run the next step if its <i>Run</i> setting was set to <i>Manual</i>.</li> <li>5. When a program has finished running, a list of the Go-NoGo results for each step are displayed. Press <i>Exit</i> [F5] to exit.</li> </ol>

Display: Program Running

Display: Program Finished

Program	Step	Result
1	1	GO
1	2	GO
1	3	NG

### 3-3. Sequence function

The LSG Series supports both programs function and sequences function.

The essential difference between programs and sequences is that programs can use different operating modes for each step while sequences use the same operating mode throughout the whole sequence. In effect sequences are used to create complex load simulations.

There are two different types of Sequences, Normal Sequences function and Fast Sequences function.

Normal sequences function can define the execution time and slew rate of each step.

On the other hand the execution time for each step in a fast sequence function is fixed to the rate (Time Base setting) set by the user.

#### 3-3-1. Normal Sequence function Overview

Description	<p>A normal sequence is comprised of a user-defined number of steps that when executed in sequence can be used to simulate a DC load.</p> <p>Up to 1000 discrete steps can be configured using normal sequences.</p> <p>Each normal sequence can have a memo note attached to it</p> <p>Normal Sequences can be looped up to 9999 discrete times or for an infinite amount of times.</p> <p>Normal sequences can be configured to hold a set voltage, current, power or resistance at the end of the load.</p> <p>Normal Sequences can be linked together in a chain.</p>
Illustration	<pre> graph TD     Start[Start Sequence] --&gt; Seq1[Sequence 1]     Seq1 --&gt; Seq2[Sequence 2]     Seq2 -.- Seq10[Sequence 10]     Seq1 --- S1[STEP 01 STEP 02 ⋮ STEP N]     Seq2 --- S2[STEP 01 STEP 02 ⋮ STEP N]     Seq10 --- S10[STEP 01 STEP 02 ⋮ STEP N]     </pre>

Edit Description	Normal Sequence configuration is split into Timing Edit configuration and Data Edit configuration. Timing Edit configuration is used to configure the actual sequences, such as mode, range, loops and chains. Data Edit configuration is used to create the actual steps used in each sequence. See below for a description of each.	
Timing Edit Overview	A Normal Sequence contains the following timing settings for each sequence:	
Setting	Setting Range	Description
Start	S01 ~ S10	Sets which sequence are used to start a chain of Normal Sequences.
Seq.No	S01 ~ S10	Sets the current sequence to edit.
Memo	12 characters	A user-created note for the currently selected sequence.
Mode	CC, CR, CV, CP	Operating mode for the sequence. +CV mode is supported.
Range	ILVL	Low I range, Low V range
	IMVL	Middle I range, Low V range
	IHVL	High I range, Low V range
	ILVH	Low I range, High V range
	IMVH	Middle I range, High V range
	IHVH	High I range, High V range
Loop	Infinite, 01 ~ 9999	Sets the amount of times to loop the selected sequence.
Last Load	OFF, ON	Set the load condition after the end of the sequence.
Last	Value	The setting value of the load for when Last Load = ON.
Chain	Off, S01~S10	Sets the next sequence in the chain, when not set to off.



Data Edit Overview	Each step in a normal sequence contains the following setting parameters:	
Setting	Setting Range	Description
Step	0001 ~ 1000	Selects and displays the current step in the sequence. The number of available steps is dependent on the number of steps added using the <i>Insert Point</i> [F1] functions.
Value		The current, voltage, power or resistance setting for the selected operating mode.
Time	0.05ms - 999h:59m	Sets the step time for the selected step.
Load	ON, OFF	Turns the load on or off for the selected step.
RAMP	ON, OFF	When turned on the current transition is evenly ramped from the start of the step to the end of the step. When turned off the current transition is stepped.

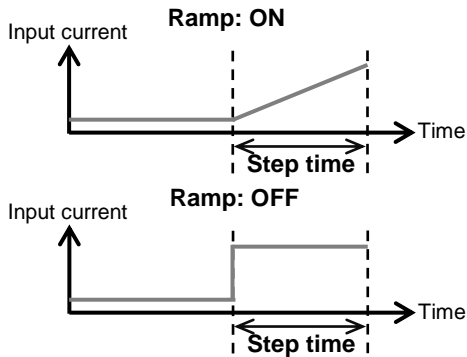

TRIG OUT	ON, OFF	<p>When TRIG OUT is set to ON, a trigger signal is output from the TRIG OUT BNC terminal at the start of the step. See page 153 (4-1-16-1. Trigger Signal Output) for details.</p>
<p>The diagram shows two signals over time. The top signal is 'Input current', which starts at a low level and then rises to a higher level at a point marked 'Start of step'. The bottom signal is 'TRIG OUT', which is a pulse that occurs exactly at the 'Start of step' time. The pulse is labeled 'TRIG OUT: ON' above it and 'TRIG OUT' below it.</p>		
PAUSE	ON, OFF	<p>Pause: Inserts a pause at the end of the step. When paused, the unit will pause at the end of step current/voltage/resistance/power level. The sequence can be resumed by pressing <i>Next</i> [F2] or by using an external trigger signal. See page 150 (4-1-12. External Trigger Signal) for details.</p>

### 3-3-2. Timing Edit Configuration

Edit Timing  
Display

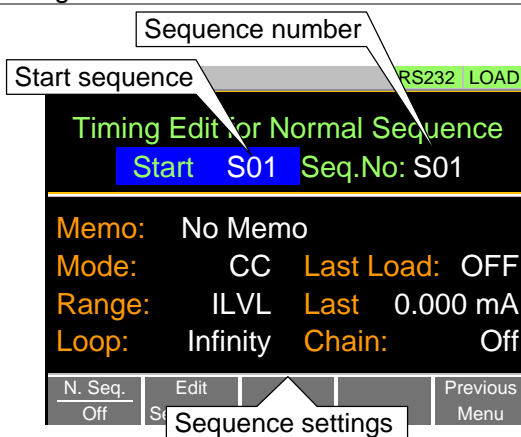

Operation

1. Press **FUNC** > *Normal Sequence* [F2] in order.  
Note; *N. Seq.* [F1] is off by default.
2. Select *Start* and select the number of the start sequence.  
Start: S01 ~ S10
3. Select a *Seq. No.* and select which sequence number to edit.  
Seq. No.: S01 ~ S10
4. Set the following parameters for the currently selected sequence. See page 92 for details on each parameter.  
Memo, Mode, Range, Loop  
Last Load, Last, Chain
5. Press *Save* [F3] to save the timing settings for the currently selected sequence.

Sequence Timing configuration is complete.

Go to Data Edit to edit the steps used in the Normal Sequences. See page 96 (3-3-3. Data Edit Configuration).  
Go to Running a Normal Sequence to run the normal sequence. See page 97 (3-3-4. Running a Normal Sequence function).

### 3-3-3. Data Edit Configuration

Data Edit  
Display

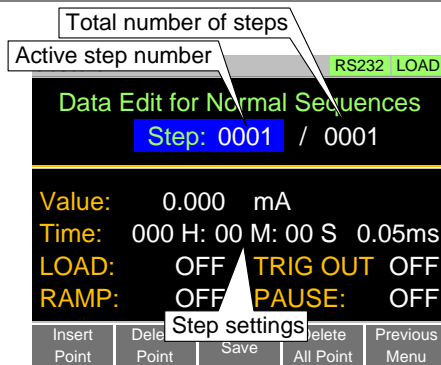

Operation

1. Press **FUNC** > *Normal Sequence* [F2] in order.
2. Select *Seq.No.* and select the sequence you wish to edit.  
Start: S01 ~ S10
3. Press *Edit Sequence* [F2] to enter the Data Edit configuration menu.  
Note; when there no steps in the current sequence the “Data Edit for Normal Sequence settings” is blank.
4. Press *Insert Point* [F1], add a step of the sequence.  
Every time *Insert Point* [F1] is pressed the new *Step* is incremented.  
The inserted point becomes the current step.
5. Set the following parameters for the currently selected step. See the Data Edit Overview on page 93 for configuration details.  
Value, Time, LOAD, RAMP, TRIG OUT, PAUSE
6. If you wish to edit a previously inserted step, use the *Step* parameter.  
Steps can only be selected after they have already been inserted.  
Steps: 0001 ~ 1000
7. The currently selected step can be deleted using the *Delete Point* [F2] function.
8. After all the steps for the sequence is complete, press *Save* [F3] to save the steps.

Data Edit for Normal Sequence configuration is complete.

Go to Timing Edit for Normal Sequences to edit the sequence.

See page 95 (3-3-2. Timing Edit Configuration).

Go to Running a Normal Sequence to run the normal

sequence. Page 97 (3-3-4. Running a Normal Sequence function).

### 3-3-4. Running a Normal Sequence function

Description	Turn the load on, the Normal Sequence function is running.
Operation	<ol style="list-style-type: none"> <li>1. Press <b>FUNC</b> &gt; <i>Normal Sequence</i> [F2] in order.</li> <li>2. Turn normal sequence mode on by setting <i>N. Seq.</i> [F1] to on.  <b>NSEQ</b> will appear at the top of the LCD Display when <i>N. Seq.</i> is On.</li> <li>3. Turn the load on.            See page 82 (3-1-2. Turning on the Load with the Selected Function) for the load on.            The normal sequence function starts immediately.            The <b>NSEQ</b> icon turns orange when the load is turned on.</li> <li>4. When a normal sequence function is running, the LCD displays which sequence number, step number and number of loop are currently active. It also displays the elapsed or remaining test time and elapsed/remaining time of the current step.</li> </ol>

Sequences can be paused by pressing *Pause*[F1] and resumed again by pressing *Continue*[F1].  
 If no steps have been created “No N.Seq.” will be displayed on the screen.  
 “*Sequence Complete*” will be displayed at the end of the sequence.

Display:  
Sequence  
Running

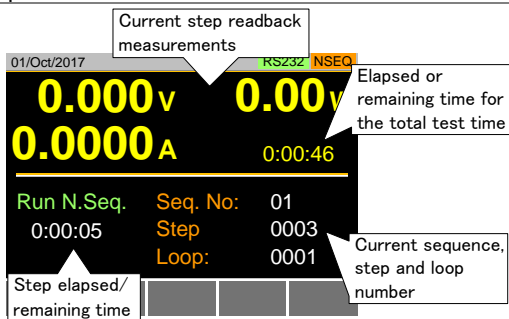

Note

The combined test time for all sequences will be displayed as elapsed test time if the elapsed time is >1000 hours, else the remaining test time will be displayed.

### 3-3-5. Fast Sequence function Overview

---

**Description** A fast sequence is comprised of a user-defined number of steps that can be executed at a high frequency. Unlike normal sequences, each step in a fast sequence has the same execution time (time base).  
This mode is only available for CC and CR mode.  
Up to 1000 discrete steps can be configured using fast sequences.  
Each fast sequence can have a memo note attached to it.  
Fast Sequences can be looped up to 9999 discrete times or for an infinite amount of times.  
Fast sequences can be configured to hold a set current or resistance at the end of the load.  
No ramping function can be used with the Fast Sequence function.

---

**Illustration**

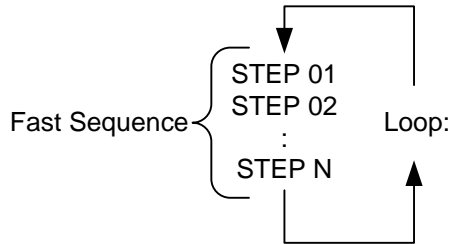

**Description** Fast Sequence configuration is split into Timing Edit configuration and Data Edit configuration. Timing Edit configuration is used to configure all the settings that are common to all the steps of the fast sequence. This includes settings such as the mode, range, loops and time base. Data Edit configuration is used to create the actual steps used in each steps.  
See below for a description of each.

---

Timing Edit Overview	A Fast Sequence contains the following timing settings for sequence:	
Setting	Setting Range	Description
Memo	12 characters	A user-created note for the currently selected sequence.
Mode	CC, CR	Operating mode for the sequence.
Range	ILVL	Low I range, Low V range
	IMVL	Middle I range, Low V range
	IHVL	High I range, Low V range
	ILVH	Low I range, High V range
	IMVH	Middle I range, High V range
	IHVH	High I range, High V range
Loop	Infinity, 01 ~ 9999	Sets the amount of times to loop the selected sequence.
Last Load	OFF, ON	Set the load condition after the end of the sequence.
Last	0.000000 A	The load setting for when Last Load is set to ON.
RPTSTEP	0001 ~ 1000	Last step number (0001~1000) per loop
Time Base	0.025 ~600ms	Sets the step execution time.

Data Edit Overview	Each step in a fast sequence contains the following setting parameters:	
Setting	Setting Range	Description
Step	0001 ~ 1000	<p>Selects and displays the current step in the sequence.</p> <p>The number of available steps is dependent on the number of steps added using the <i>Insert Point</i> [F1] functions.</p> <p>A minimum of 3 steps.</p>
Value	The current or resistance setting for the selected operating mode.	
TRIG OUT	ON, OFF	<p>When TRIG OUT is set to ON, a trigger signal is output from the TRIG OUT BNC terminal at the start of the step.</p> <p>See page 153 (4-1-16-1. Trigger Signal Output) for details.</p>

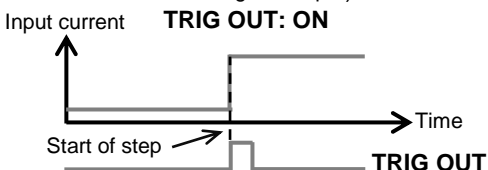



**FILL Overview**

The FILL function is used to evenly step up the current or resistance value settings from a starting step to a finishing step.

The Fill Function can be used before or after steps are added to the fast sequence.

Before: Will pre-fill each value within the fill range when a new step is added.

After: Will post-fill each value within the fill range.

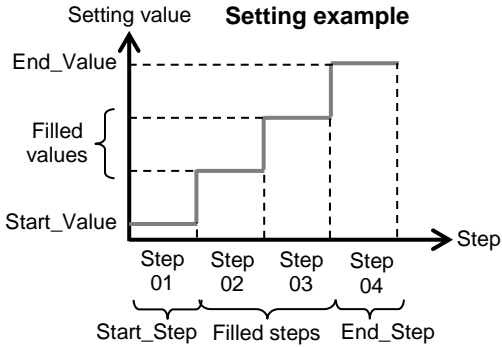

Setting	Setting Range	Description
Start_Value		Sets the current or resistance value for the starting step.
End_Value		Sets the current or resistance value for the ending step.
Start_Step	0001 ~ 1000	Sets the starting step number.
End_Step	0001 ~ 1000	Sets the ending step number.

### 3-3-6. Timing Edit Configuration

Edit Timing  
Display

01/Oct/2017		RS232 LOAD	
<b>Timing Edit for Fast Sequence</b>			
<b>Memo:</b> 001			
<b>Mode:</b> CC	<b>Last Load:</b> OFF		
<b>Range:</b> ILVL	<b>Last</b> 0.000 mA		
<b>Loop:</b> Infinity	<b>RPTSTEP</b> 0004		
<b>Time Base:</b> 600.00 ms			
F. Seq. Off	Edit Sequence	Sequence	Previous Menu

Operation

1. Press **FUNC** > *Fast Sequence* [F3] in order.  
Note; *F. Seq.* [F1] is off by default.
2. Set the following parameters for the fast sequence.  
See page 99 for details on each parameter.  
Memo, Mode, Range, Loop, Time Base  
Last Load, Last, RPTSTEP

Save

Press **Save** [F3] to save the timing settings for the fast sequence.

Sequence Timing configuration is complete.  
Go to Data Edit to edit the steps used in the Fast Sequence. Page 103 (3-3-7. Data Edit Configuration).  
Go to Running a Fast Sequence to run the fast sequence. Page 105 (3-3-8. Running a Fast Sequence function).

### 3-3-7. Data Edit Configuration

Data Edit Display

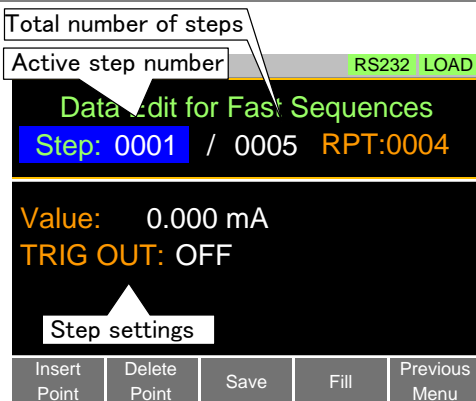

Operation  
(1/2)

1. Press **FUNC** *Fast Sequence* [F3] > *Edit Sequence* [F2] in order to enter the Data Edit configuration menu.
2. Press *Insert Point* [F1] to add a step to the sequence. Every-time *Insert Point* [F1] is pressed the new *Step* is incremented.  
The newly inserted "Point" becomes the active step.
3. Set the following parameters for the currently selected step. See page 100 for configuration details.  
Value, TRIG OUT
4. If you wish to edit a previously added point/step, use the *Steps* parameter.  
Steps can only be selected after they have already been added.  
Steps 0001 ~ 1000(RPTSTEP)
5. The currently selected step can be deleted using the *Delete Point* [F2] function.  
There cannot be less than 3 steps for fast sequences.

Operation  
(2/2)

6. Presses *FILL* [F4] to use the fill function. Set the FILL parameters. See page 101 for configuration details. The fill function can be used any number of times. Start\_Value, End\_Value, Start\_Step, End\_Ste

FILL Display

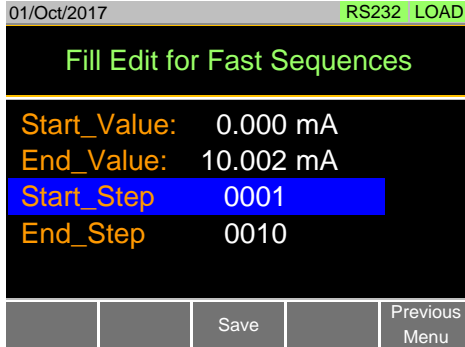

Save

After all the steps for the sequence are complete, presses *Save* [F3] to save the steps.

Data Edit for Fast Sequences configuration is complete. Go to Timing Edit for Fast Sequences to edit the sequence. Page 102 (3-3-6. Timing Edit Configuration). Go to Running a Fast Sequence to run the fast sequence. Page 105 (3-3-8. Running a Fast Sequence function).

### 3-3-8. Running a Fast Sequence function

Description	Turn the load on, the Fast Sequence function is running.
Operation	<ol style="list-style-type: none"> <li>1. Press <b>FUNC</b> &gt; <i>Fast Sequence</i> [F3] in order.</li> <li>2. Turn fast sequence mode on by setting <i>F. Seq.</i> [F1] to on. <b>FSEQ</b> will appear at the top of the display when <i>F. Seq.</i> is on.</li> <li>3. Turn the load on. See page 82 (3-1-2.Turning on the Load with the Selected Function) for the load on. The fast sequence function starts immediately. The <b>FSEQ</b> icon turns orange when the load is turned on.</li> <li>4. When a fast sequence is running, the screen displays which step and loop is currently active. "Sequence Complete" will be shown on the display at the end of the sequence.</li> </ol>

Display:  
Fast Sequence  
Running

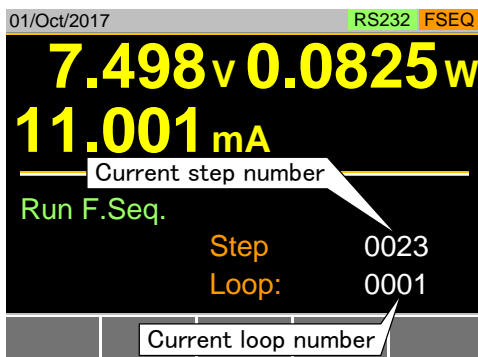

### 3-4. OCP Test function

**Description** The OCP test function creates an automatic test to test the OCP of power supply products. This test will test to see when the over current protection of a power supply is tripped and return the measurements for the voltage and current when the over current protection was tripped. The LSG-H also has a user-defined cutoff setting in the event that the power supply OCP fails.

The diagram below shows an example of the OCP Test function:  
The test current increases from a starting value (Start C) to an end value (End C). The current increases in steps (set by Step C) with a set step time (set by Step T) until the power supply's OCP is tripped or the End C current level is reached.

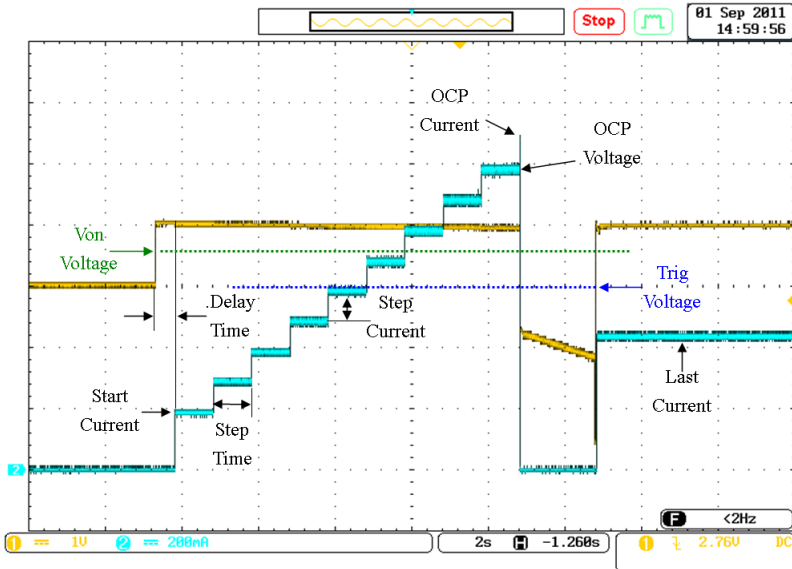

### 3-4-1. OCP Test function setting parameters

Parameters	No.	Selects one of 12 OCP test setup memories.
	Memo	A user-created note for the currently selected OPP function.
	Range	Select the Range of CC Mode. (High, Middle, Low)
	Start Current (Start C)	Starting start current value for the test.
	End Current (End C)	The current value that will end the test. The value must be higher than the OCP value of the power supply you are testing. This parameter is used as a fail-safe for if the over current protection of the power supply fails. If the measured current is reaches End Current value it would then indicate that the power supply OCP failed.
	Step Current (Step C)	Sets the step resolution of the current.
	Step Time (Step T)	Sets the execution time of each step. (50ms to 1600s)
	Delay Time (Delay)	The OCP testing delay time. Sets the how long to delay starting the test after the Load On key has been pressed (5ms ~ 160ms).
	Trig Voltage (Trig V)	Sets the trigger to a level needed to see when the power supply OCP has been triggered. When the power supply OCP has been triggered, its voltage output will reset. The voltage trigger level is used to test to see if the voltage output has been reset.
	Last Current (last C)	Sets the final current value after OCP has been tripped. This is the steady-state current draw after the OCP has been tripped.
		This mode can only be used under CC mode.



Note

### 3-4-2. OCP Test function setting

Operation

1. Press **FUNC** > OCP [F4] > OCP ON [F1] in order.
2. Select No.: and select a test setup memory.  
No.: 1 ~ 12
3. Set the following parameters for the selected test setup above.  
See page 107 for details on each parameter.  
Memo, Range, Start C, End C, Step C  
Step T, Delay, Trig V, last C  
Each setting parameters are saved in the internal memory.

Display

10/Jan/2019		USB	OCP
OCP Function		No.:	01
Memo:	No Memo		
Range:	Low	Step T:	0.10
Start C:	0.00006	Delay:	0.00
End C:	0.06000	Trig V:	2.00
Step C:	0.00060	last C:	0.00000
OCP			Previous
ON			Menu



### 3-4-3. Running a OCP Test function

Operation

1. Press **FUNC** > *OCP* [F4] > *OCP ON* [F1] in order.
2. Turn the load on.  
See page 82 (3-1-2.Turning on the Load with the Selected Function) for the load on.  
The test current will increase from the Start C value to the End C value in steps according to the Step C value, until the test has finished.  
The test will start running when the power supply voltage is greater than the Trig V voltage.

Example:  
OCP Function  
running

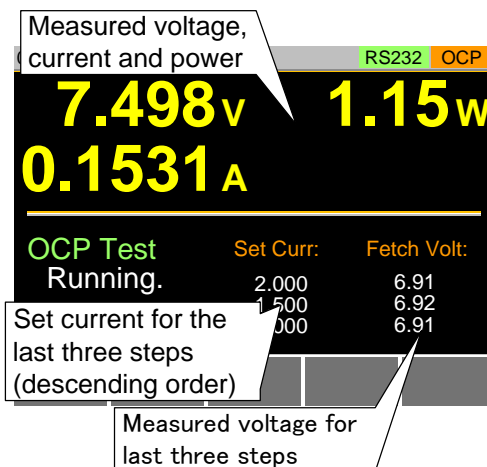

### 3-4-4. Results of OCP Test function

Power Source  
OCP tripped

The OCP Test will return the current setting of the last step when the power supply's OCP was tripped.

01/Oct/2017 RS232 OCP

7.498v      0.00w

0.0000A

---

OCP Test	Set Curr:	Fetch Volt:
Current:	2.000	6.91
2.500A	1.500	6.92
	1.000	6.91

Indicating power supply OCP was tripped.

Step current setting on the load when the power supply's OCP was tripped.

Power Source  
OCP timeout

OCP time out will occur if the power supply's OCP fails to trigger. This is determined when the measured voltage is less than Trig V and the measured current is greater than End C.

01/Oct/2017 RS232 OCP

7.498v      0.00w

0.0000A

---

OCP Test	Set Curr:	Fetch Volt:
OCP time out	2.000	6.91
	1.500	6.92

OCP time out indicates that the power supply OCP was not tripped.

Power Source  
Config Error

Config Error indicates that the power supply voltage is less than the Trig V voltage setting after the test has started. This can indicate that the power supply output is not on or that the power supply output or Trig V is incorrectly configured.

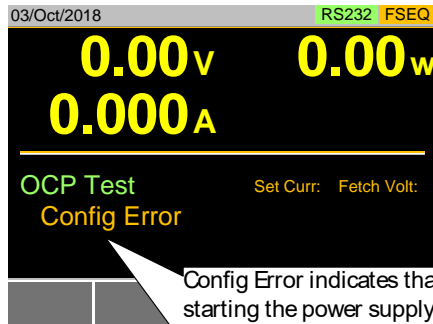

Note

In addition to the OCP settings as described above, the Trig Voltage settings must also be set according to the output characteristics of the power supply.

Save Data

When the Power Source OCP was tripped. Press TEST Result [F1] to view the test result waveform.

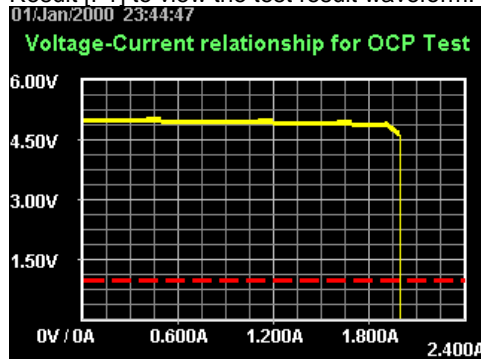

Plug in USB flash drive and press Save [F3] to save the waveform picture.

Press Esc [F1] to exit the waveform view mode.

Press Save [F3] to save the data log to USB flash drive.

The file name should be RESULTxx.CSV. The file RESULTxx.CSV can be opened in the computer.

The maximum amount of data to be recorded in the data log is 65536. If data exceeds this limit, the extra data won't be recorded.

	A	B	C	D	E	F
1	<< OCP TEST >>			PEL-3021A v1.32		
2	< PARAMETER of OCP TEST >					
3		OCP No.:		1		
4		(1) Memo:				
5		(2) Range:	Middle			
6		(3) Start Curr:	0.001 A			
7		(4) End Curr:	3.000 A			
8		(5) Step Curr:	0.100 A			
9		(6) Step Time:	0.05 s			
10		(7) Delay Time:	0.00 s			
11		(8) Trig Volt:	1.00 V			
12						
13	< TEST RESULTS >					
14		Start Time:	2000/1/1 23:44			
15		End Time:	2000/1/1 23:44			
16		(1) Test Result:	Complete	OCP :	2.001 A	
17						
18		(2) DATA LISITS(22):				
19		Step No	VOLT(V)	CURR(A)	POWER(W)	
20		0	4.98	0.011	0.05478	
21		1	4.98	0.01	0.0498	
22		2	4.98	0.103	0.51294	
23		3	4.97	0.202	1.00394	
24		4	4.96	0.303	1.50288	
25		5	4.96	0.403	1.99888	

### 3-5. OPP Test function

Description	The OPP test function creates an automatic test to test the OPP of power supply products. This test will test to see when the over power protection of a power supply is tripped and return the measurements for the voltage and current when the over power protection was tripped. The LSG-H also has a user-defined cutoff setting in the event that the power supply OPP fails.
-------------	---

The diagram below shows an example of the OPP Test function:

The test watt increases from a starting value (Start W) to an end value (End W). The watt increases in steps (set by Step\_W) with a set step time (set by Step\_T) until the power supply's OPP is tripped or the End W watt level is reached.

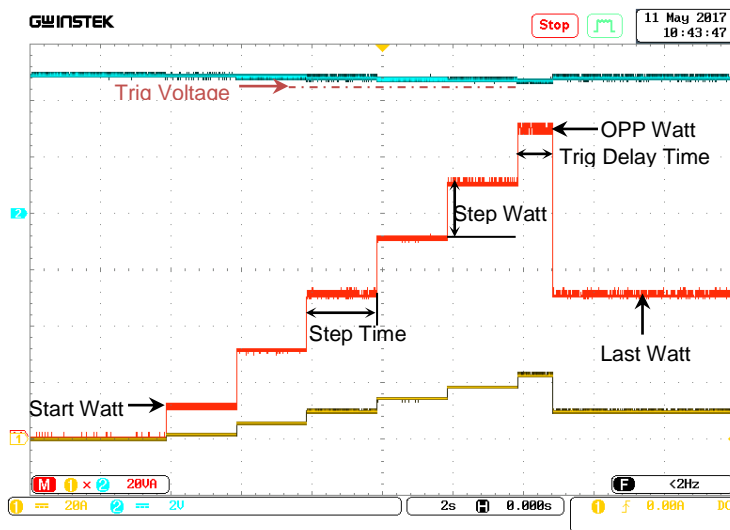

### 3-5-1. OPP Test function setting parameters

Parameters	No.	Selects one of 12 OPP test setup memories.	
	Memo	A user-created note for the currently selected OPP function.	
	Range	Select the Range of CP Mode. (High, Middle, Low)	
	Start Watt (Start W)	Starting start watt value for the test.	
	End Watt (End W)	The watt value that will end the test. The value must be higher than the OPP value of the power supply you are testing. This parameter is used as a fail-safe for if the over power protection of the power supply fails. If the measured watt is reaches End Watt value it would then indicate that the power supply OPP failed.	
	Step Watt (Step W)	Sets the step resolution of the watt.	
	Step Time (Step T)	Sets the execution time of each step. (10ms to 50s)	
	Trig Delay Time (Delay)	Sets a delay corresponding to the time a Trig Voltage can be expected after each step Watt is applied (the delay time must be less than the Step time).	
	Trig Voltage (Trig V)	Sets the trigger to a level needed to see when the power supply OPP has been triggered. When the power supply OPP has been triggered, its voltage output will reset. The voltage trigger level is used to test to see if the voltage output has been reset.	
	Last Watt (last W)	Sets the final watt value after OPP has been tripped. This is the steady-state watt draw after the OPP has been tripped.	
			This mode can only be used under CP mode.
	 Note		

### 3-5-2. OPP Test function setting

Operation

1. Press **FUNC** > *Next Menu* [F5] > *OPP* [F1] in order.
2. Select *No.:* and select a test setup memory.  
*No.:* 1 ~ 12
3. Set the following parameters for the selected test setup above.  
 See page 114 for details on each parameter.  
 Memo, Range, Start W, End W, Step W  
 Step T, Delay, Trig V, last W  
 Each setting parameters are saved in the internal memory.

Display

01/Oct/2018		USB	OPP
OPP Function		NO.: 01	
Memo:	No Memo		
Range:	Low	StepT:	0.10
Start W:	0.0000	Delay:	0.00
End W:	0.0001	Trig V:	2.50
Step W:	0.0001	last W:	0.0000
OPP ON			Previous Menu

### 3-5-3. Running a OPP Test function

---

Operation

1. Press **FUNC** > *Next Manu* [F5] > *OPP* [F1] in order, and Press *OPP ON* [F1] to turn OPP ON.
  2. Turn the load on.  
See page 82 (3-1-2.Turning on the Load with the Selected Function) for the load on.  
The test watt will increase from the Start W value to the End W value in steps according to the Step W value, until the test has finished.  
The test will start running when the power supply voltage is greater than the Trig V voltage.
- 

Example:  
OPP Function  
running

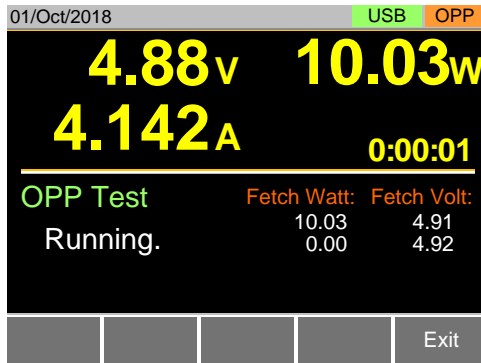



### 3-5-4. Results of OPP Test function

Power Source  
OPP tripped

The OPP Test will return the current setting of the last step when the power supply's OPP was tripped.

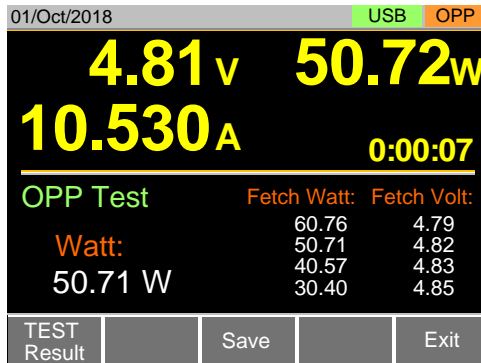

Power Source  
OPP timeout

OPP time out will occur if the power supply's OPP fails to trigger. This is determined when the measured voltage is less than Trig V and the measured watt is greater than End W.

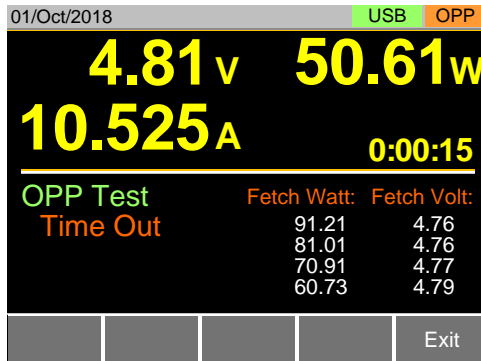

Power Source  
Config Error

Config Error indicates that the power supply voltage is less than the Trig V voltage setting after the test has started. This can indicate that the power supply output is not on or that the power supply output or Trig V is incorrectly configured.

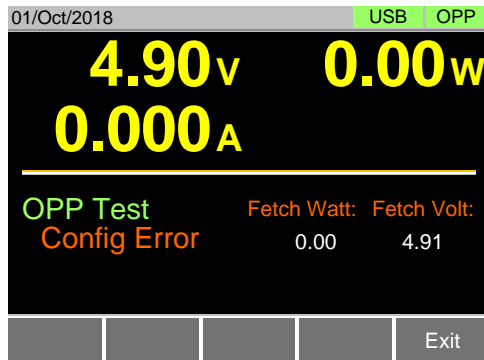

Note

In addition to the OPP settings as described above, the Trig Voltage settings must also be set according to the output characteristics of the power supply.

Save Data

When the Power Source OPP was tripped. Press TEST Result [F1] to view the test result waveform.

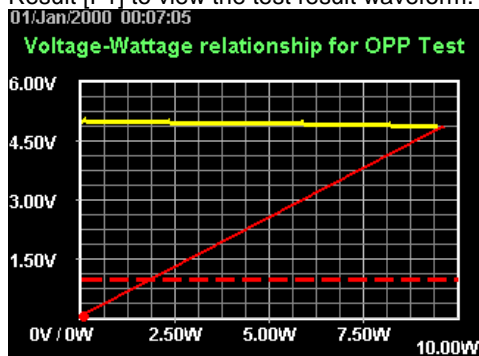

Plug in USB flash drive and press Save [F3] to save the waveform picture.

Press Esc [F1] to exit the waveform view mode.

Press Save [F3] to save the data log to USB flash drive.

The file name should be RESULTxx.CSV. The file RESULTxx.CSV can be opened in the computer.

The maximum amount of data to be recorded in the data log is 65536. If data exceeds this limit, the extra data won't be recorded.

	A	B	C	D	E	F
1	<< OPP TEST >>			PEL-3021A v1.32		
2	< PARAMETER of OPP TEST >					
3		OPP No.:		1		
4		(1) Memo:				
5		(2) Range:	Middle			
6		(3) Start Watt:	0.01000 W			
7		(4) End Watt:	15.00000 W			
8		(5) Step Watt:	0.10000 W			
9		(6) Step Time:	0.10 s			
10		(7) Delay Time:	0.00 s			
11		(8) Trig Volt:	1.00 V			
12						
13	< TEST RESULTS >					
14		Start Time:	2000/1/1 00:07			
15		End Time:	2000/1/1 00:07			
16		(1) Test Result:	Complete	OPP :	9.6612 W	
17						
18		(2) DATA LISITS(101):				
19		StepNo	VOLT(V)	CURR(A)	POWER(W)	
20		0	4.98	0.01	0.0498	
21		1	4.98	0.01	0.0498	
22		2	4.98	0.01	0.0498	
23		3	4.98	0.01	0.0498	
24		4	4.98	0.01	0.0498	
25		5	4.99	0.019	0.09481	

### 3-6. BATT Test function

---

Description	<p>The BATT test function creates an automatic test to test the discharge of Battery products.</p> <p>The test will discharge in a fixed mode (CC, CR, CP) and will end after a defined stop point (stop voltage, stop time, stop AH) has been detected. The information about discharge test (discharge time, battery AH, battery WH) can be finally seen on the panel.</p> <p>The LSG/LSG-H also has a user-defined cutoff setting in the event that the Battery test fails.</p>
-------------	--

---

The diagram below shows an example of the BATT Test function:

The test will run in the specified mode with defined values and will stop when the defined stop values are reached.

Example: Discharge CC mode

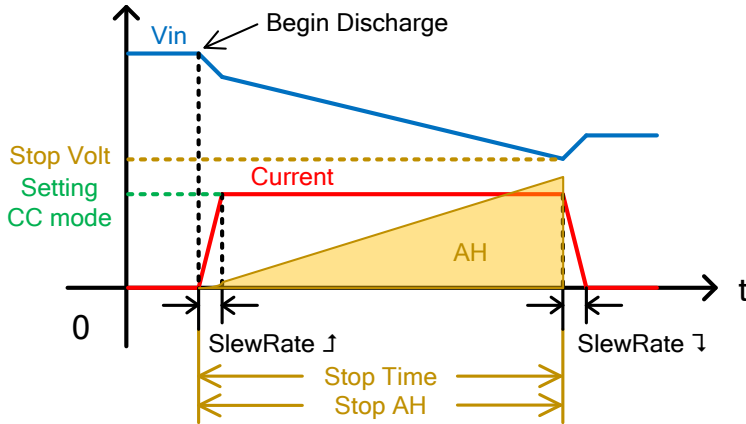

Example: Discharge CR mode

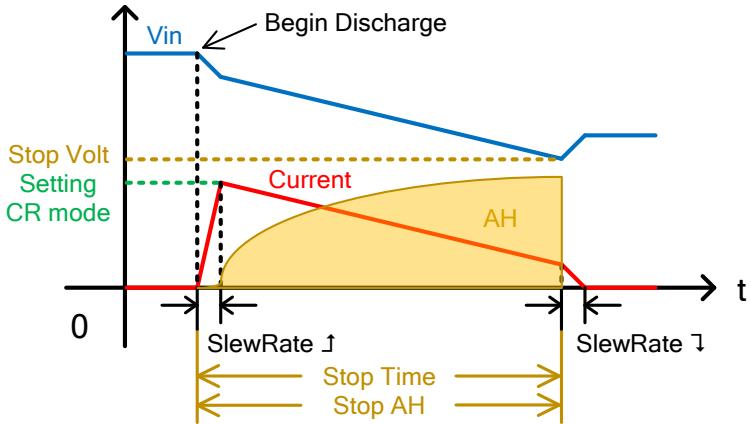

Example: Discharge CP mode

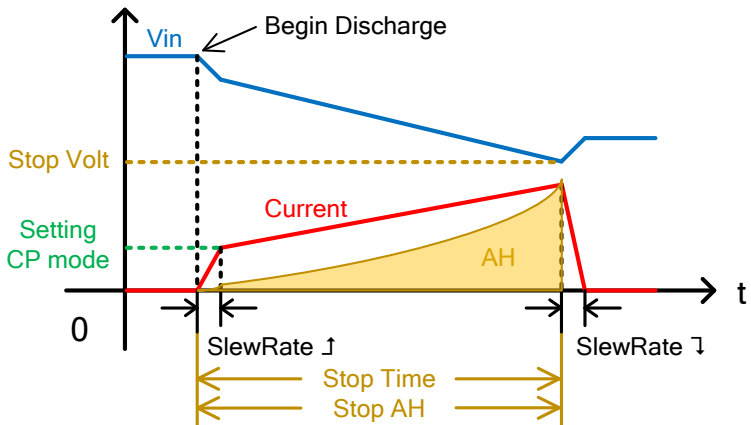

### 3-6-1. BATT Test function setting parameters

Parameters	BATT No.	Selects one of 12 BATT test setup memories.
	Memo	A user-created note for the currently selected BATT Test function.
	Mode	Select a discharge operation mode. (CC, CR, CP)
	Range	Select I Range (High, Middle, Low) and V Range (High, Low). Example: ILVL(I range Low, V range Low)
	Setting	Sets the values corresponding to the defined discharging mode (CC mode in A, CR mode in mS and CP mode in W).
	Slew Rate $\uparrow$	Sets the test rising slew rate in mA/us (not adjustable for CP mode).
	Slew Rate $\downarrow$	Sets the test falling slew rate in mA/us (not adjustable for CP mode).
	Stop Volt	Sets the voltage at which the test should be interrupted. The value must be lower than the battery start voltage.
	Stop Time	Sets the time after which the test should be interrupted (max value is 999h: 59m: 59s).
	Stop AH	Sets the discharged energy rate at which the test should be interrupted (Max value is 9999.99Ah).
	Datalog timer	Sets the time interval for data capture (1~120 seconds). Up to 65,535 data can be saved when running data logging function. When logging data reaches to the maximum amount, it won't be saved and be ignored.

### 3-6-2. BATT Test function setting

Operation

1. Press **FUNC** > *Next Menu* [F5] > *BATT* [F2] in order.
2. Set the following parameters for the selected test setup above.  
 See page 122 for details on each parameter.  
 BATT No., Memo, Mode, Range, Setting  
 Slew Rate $\uparrow$ , Slew Rate $\downarrow$   
 Stop Volt, Stop Time, Stop AH, Datalog timer  
 Each setting parameters are saved in the internal memory.

Display

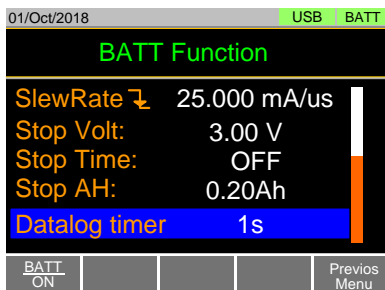
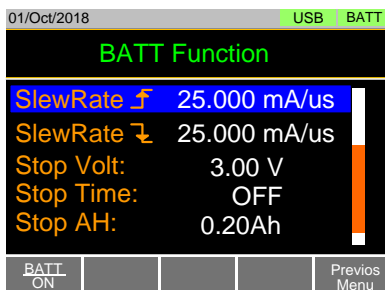
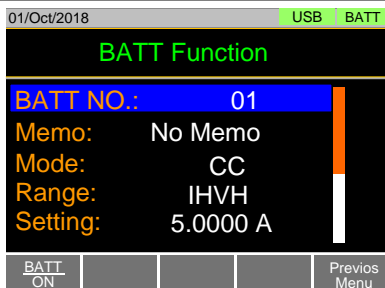

### 3-6-3. Running a BATT Test function

Operation

1. Press **FUNC** > *Next Menu* [F5] > *BATT* [F2] in order, and Press *BATT* [F1] to turn the BATT function on.
2. Turn the load on.  
See page 82 (3-1-2. Turning on the Load with the Selected Function) for the load on.  
The discharge test will keep running with its defined mode and values until any of the Stop Voltage, Stop Time or Stop AH settings is detected.

Example:  
BATT Test  
Function running

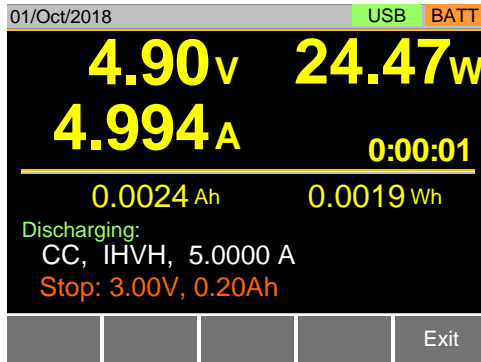

### 3-6-4. Results of BATT Test function

Description

The BATT Test will return the information of the last discharge when the Battery stop voltage or stop time or stop AH was tripped.

Test stop for  
Voltage tripped





Test stop for  
time tripped



Test stop for  
AH tripped



Note

In addition to the BATT Test function settings as described above, the Stop Volt Voltage settings must also be set according to the output characteristics of the power supply.

### 3-6-5. Save the Data for BATT Test function

Operation

1. When the Battery stop voltage, stop time or stop AH was tripped. Press *TEST Result* [F1] to view the test result waveform. Press *Esc* [F1] to exit the waveform view mode.



2. Plug in USB flash drive and press *Save* [F3] to save the waveform picture.

Press *Save* [F3] to save the data log to USB flash drive. The file name should be RESULTxx.CSV. The file RESULTxx.CSV can be opened in the computer.

	A	B	C	D	E	F	G
1	<< BATT TEST >>			PEL-3XXX	v1.31.003		
2	< PARAMETER of BATT TEST >						
3		BATT No.:		1			
4		(1) Memo:					
5		(2) Mode:	CC				
6		(3) Range:	IHVH				
7		(4) Set CC:	1.000 A				
8		(5) Stop Volt:	3.00 V				
9		(6) Stop Time:	0 h	0 m	10 s		
10		(7) Stop AH:	0.20 Ah				
11							
12	< TEST RESULTS >						
13		Start Time:	2000/1/1 07:01				
14		End Time:	2000/1/1 07:01				
15		(1) Test Length:	0 h	0 m	8 s		
16		(2) Recorder Length:	0 h	0 m	8 s		
17		(3) Stop Condition:	Under VOLT				
18		(2) DATA LISITS(9):	Timebase(sec):	1 s			
19	No	VOLT(V)	CURR(A)	POWER(WAH)	WH		
20		0	10.01	0.002	0.02002	0	0
21		1	9.84	0.998	9.82032	0.0002	0.0024
22		2	8.85	0.998	8.89218	0.0005	0.005
23		3	7.85	0.998	7.8343	0.0008	0.0074
24		4	6.85	0.998	6.84628	0.0011	0.0096
25		5	5.87	0.998	5.85826	0.0014	0.0115
26		6	5.85	0.998	5.8383	0.0016	0.0131
27		7	4.86	0.998	4.85028	0.0019	0.0145
28		8	2.86	0.998	2.85428	0.0022	0.0157
29							

### 3-7. MPPT

#### Background

The MPPT (Maximum Power Point Tracking) function of LSG series can perform IV, PV characteristics and Pmax tracking tests of solar panels.

#### Note

The firmware Ver.1.29 or later is compatible with this extended function. Operation is not supported.

#### Features of this function

It is possible to test the IV and PV characteristics of solar panels.

I-V,P-V characteristic

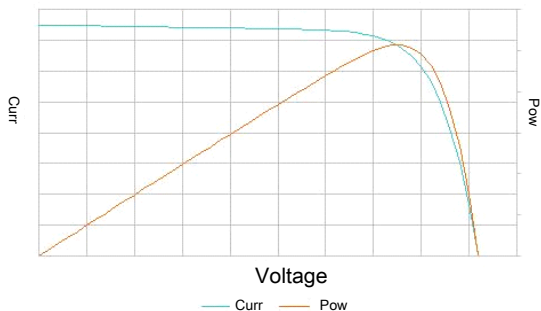

Furthermore, Pmax tracking test can be performed by turning on tracking.

MPPT

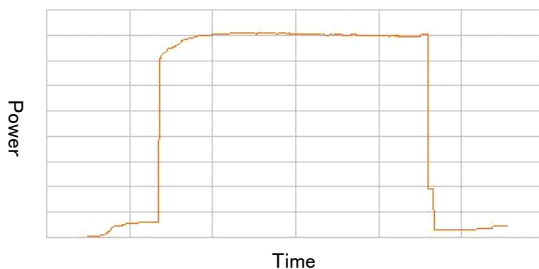

Test data is saved on USB memory. It supports USB memory up to 2GB.

#### Parameters

- |          |   |
|----------|---|
| BATT No. | Set one of 12 test patterns.  |
| Memo     | A user-created note for the currently selected BATT function.   |
| Mode     | Select a discharge operation mode. (CC, CV)   |
| Range    | Set the voltage and current range.<br>ILVL(I range low, V range low)<br>IMVL(I range middle, V range low) |

	IHVL(I range high, V range low)
	ILVH(I range low, V range high)
	IMVH(I range middle, V range high)
	IHVH(I range high, V range high)
Response	Set the response speed of each discharge mode. CV mode: Slow, Fast CC mode: 1, 1/2, 1/5, 1/10
Sweep Range	Set the conditions for the sweep range. CV mode: Value, Percent CC mode: Value only
Start V (Start Voltage)	Response appears only in CV mode. Set the start voltage value and its range is from 0V to the maximum of the setting voltage.
End V (End Voltage)	Response appears only in CV mode. Set the end voltage value and its range is from 0V to the maximum of the setting voltage.
Step V (Step Voltage)	Response appears only in CV mode. Set the step voltage value and its range is from 0V to half of the maximum of the setting voltage.
Start C (Start Current)	Response appears only in CC mode. Set the start current value and its range is from 0A to the maximum of the setting current.
End C (End Current)	Response appears only in CC mode. Set the end current value and its range is from 0A to the maximum of the setting current.
Step C (Step Current)	Response appears only in CC mode. Set the step current value and its range is from 0A to half of the maximum of the setting current.
Step Time	Set the step time and its range is from 0.01s to 50s.
Detect Short (Short Circuit Detection)	"Disable" only.

---

Panel operation

1. Press  > Next Manu[F5] > MPPT[F4].
-

When CV mode is set

06/Mar/2018		RS232 LOAD	
<b>MPPT Function</b>			
<b>MPPT No.:</b>		01	
<b>Memo:</b>		No Memo	
<b>Mode:</b>		CV	
<b>Range:</b>		ILVL	
<b>Response:</b>		Slow	
MPPT	Edit	Time Set	Previous
OFF	Tracking		Menu

08/Mar/2018		RS232 LOAD	
<b>MPPT Function</b>			
<b>Sweep Range:</b>		Value	
<b>Start V:</b>		0.000 V	
<b>End V:</b>		0.000 V	
<b>Step V:</b>		0.001 V	
<b>Step Time:</b>		0.01 s	
MPPT	Edit	Time Set	Previous
OFF	Tracking		Menu

08/Mar/2018		RS232 LOAD	
<b>MPPT Function</b>			
<b>Start V:</b>		0.000 V	
<b>End V:</b>		0.000 V	
<b>Step V:</b>		0.001 V	
<b>Step Time:</b>		0.01 s	
<b>Detect Short:</b>		Disable	
MPPT	Edit	Time Set	Previous
OFF	Tracking		Menu

When CC mode is set

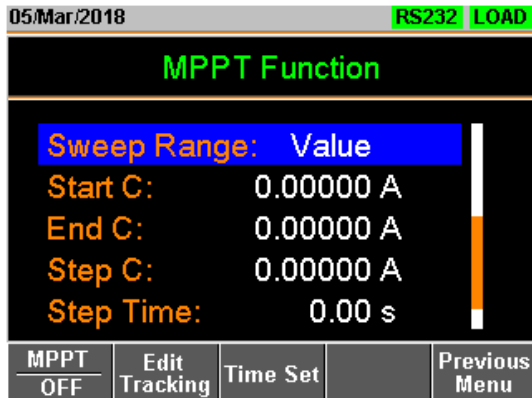
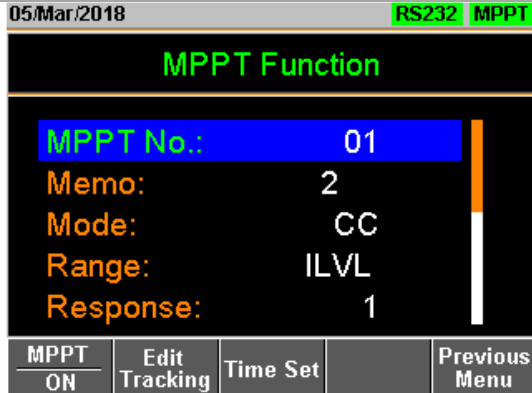

2. Set the following parameters.

- |                             |               |
|-----------------------------|---------------|
| MPPT No.                    | Memo          |
| Mode                        | Range         |
| Response                    | Sweep Range   |
| Start C (Start V)           | End C (End V) |
| Step C (Step V)             | Step Time     |
| Detect Short (Disable only) |               |

### 3-7-1. Edit Tracking of MPPT function

Background	Set tracking the maximum power point of MPPT function.	
Parameters	Tracking	Enable/ Disable tracking the maximum power point of MPPT function.
	Track Step	Set the tracking range (0.01% to 5.00%).
	Track Step Time	Set the tracking time (0.01s to 2.00 s).
	Pmax Detection (Pmax Detection Time Interval)	Set the detection time of Pmax (maximum power point) (OFF, 1m to 60m). Redetecting can also be used when the maximum power point is two.

Measure Interval (Measurement Time Interval) Set the measurement time interval (1.0s to 60.0s).

Panel operation

- Press **FUNC** > *Next Manu[F5]* > *MPPT[F4]* *Edit Tracking[F2]*.

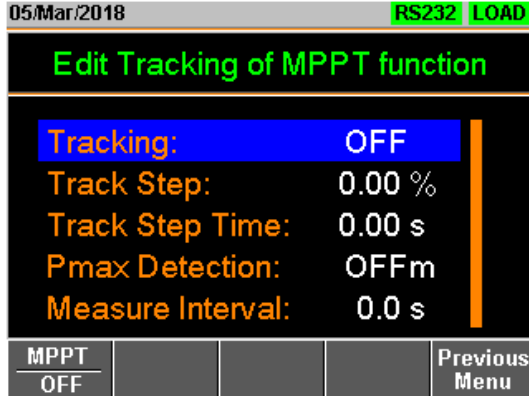

- Set the following parameters.  
 Tracking                                      Track Step  
 Track Step Time                                Pmax Detection  
 Measure Interval

### 3-7-2. Auto Load of MPPT function

Background Parameters	Auto Load on/off	Set start date and stop date of MPPT test. Set the date and time of the test.
	Disable	Set the tracking range (0.01% to 5.00%).
	Only Start	Set start date and time only.
	Only Stop	Set stop date and time only.
	Enable	Set the start and stop date, start and stop time.

Panel operation

- Press **FUNC** > *Next Manu[F5]* > *MPPT[F4]* *Time Set[F3]*.

05/Mar/2018

RS232 LOAD

### Auto Load of MPPT function

Auto Load on/off: Disable

Start Time: 00 / 00 / 00, 00 : 00 : 00

Stop Time 05 / 00 / 00, 00 : 200 : 00

Exit

06/Mar/2018

RS232 LOAD

### Auto Load of MPPT function

Auto Load on/off: Only Start

Start Time: 17 / 06 / 01, 08 : 00 : 00

Stop Time: 17 / 06 / 01, 01 : 00 : 00

Exit

06/Mar/2018

RS232 LOAD

### Auto Load of MPPT function

Auto Load on/off: Only Stop

Start Time: 17 / 06 / 01, 08 : 00 : 00

Stop Time: 17 / 06 / 01, 01 : 00 : 00

Exit



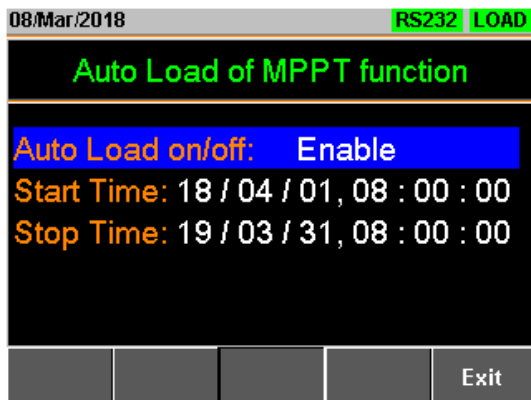

2. Set the following parameters.  
 Auto Load on/off                      Start Time  
 Stop Time

Start MPPT

1. Insert a USB flash disk into USB port in the front panel.
  2. Press MPPT [F1] to enable this function to start the test.
  3. Press Shift + Load key to start the test.
- Continue testing until the end conditions are met.

Example: MPPT  
Function running





Example: MPPT test results

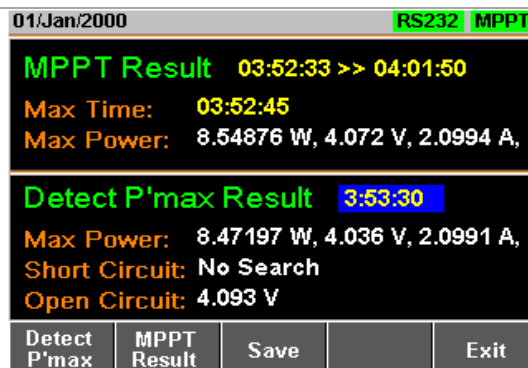

To save the test result data, press Save [F3].  
 To see the graph of the maximum power point tracking test, press Detect P'max [F1].

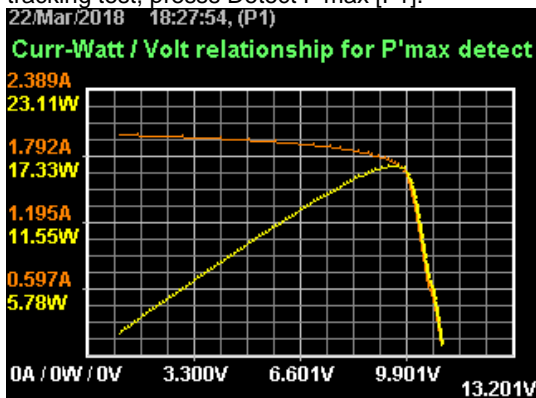

To see the graph of the MPPT exam, Press MPPT Result [F2].

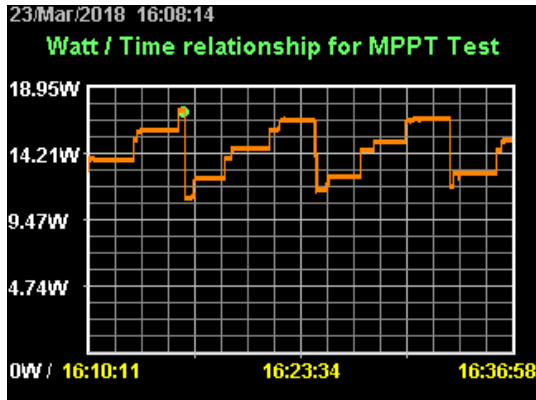

If you want to have a screen shot, press Save [F3].  
Press Esc [F1] to exit.

### 3-7-3. Data file of test result

Background                      Test result data is saved as a CSV file.

Example: Test conditions and results file

	A	B	C	D	E
1	<< MPPT TEST >>			LSG-175	vt.29.001
2					
3	<DATE>	2018/3/22 18:37			
4	<Pmax Detection Method>				
5		(1)Memo:			
6		(2)Mode:	CV		
7		(3)Range:	PHV		
8		(4)Response:	Slow		
9		(5)Sweep Range:	Value		
10		(6)Start Voltage:		1 V	
11		(7)End Voltage:		11 V	
12		(8)Step Voltage:		0.1 V	
13		(9)Step Time:		1 sec	
14		(10)Short Circuit Detection:	Disable		
15	<Hill Climbing Method Tracking>		Enable		
16		(11)Tracking:			
17		(12)Tracking Step Voltage:		1 %	
18		(13)Tracking Step Time:		1 sec	
19		(14)Pmax Detection Time Interval:		1.0 min	
20	<Measurement condition>				
21		(15)Measurement Time Interval:		1 sec	
22					
23	<MPPT TEST RESULTS>				
24		(1)Start Time	2018/3/22 18:37		
25		(2)End Time	2018/3/22 18:43		
26		(3)MAX No.	103		
27		(4)MAX Time	2018/3/22 18:40		
28		(5)MAX Voltage	9.49 V		
29		(6)MAX Current	1.754 A		
30		(7)MAX Power	16.645462 W		

<DATE>

Date of test

<Pmax Detection Method>

Settings contents for Pmax detection (in CV mode).

<Hill Climbing Method Tracking>

Setting contents of the hill climbing method.

<Measurement condition>

Measurement status.

<MPPT TEST RESULTS>

MPPT test results.

(1) Start Time

Test start time

(2) End Time

Test end time

(3) MAX No.

Number of measurement data

(4) MAX Time

Time when Pmax is maximum

(5) MAX Voltage

Voltage value when Pmax is maximum

(6) MAX Current

Current value when Pmax is maximum

(7) MAX Power

Power value when Pmax is maximum

Example: Results file of IV and PV characteristics test

	A	B	C	D
1				
2	<PMAX DETECTION RESULTS>			
3		(1) Start Time	2018/3/22 18:37	
4		(2) MAX No.	86	
5		(3) MAX Voltage	9.6 V	
6		(4) MAX Current	1.719 A	
7		(5) MAX Power	16.502401 W	
8		(6) Short Circuit	No Search	
9		(7) Open Circuit	1 V	
10		(8) DATA Lists	101	
11	No.	VOLT(V)	CURR(A)	POWER(W)
12	1	1.1	1.99	2.189
13	2	1.2	1.989	2.3868
14	3	1.3	1.988	2.5844
15	4	1.4	1.987	2.7818
16	5	1.5	1.987	2.9805
17	6	1.6	1.986	3.1776
18	7	1.7	1.985	3.3745
19	8	1.8	1.984	3.5712
20	9	1.9	1.983	3.7677
21	10	2	1.982	3.964
22	11	2.1	1.981	4.1601
23	12	2.2	1.981	4.3582
24	13	2.3	1.98	4.554001
25	14	2.4	1.979	4.7496
26	15	2.5	1.978	4.945
27	16	2.6	1.977	5.140201
28	17	2.7	1.976	5.3352
29	18	2.8	1.973	5.524401
30	19	2.9	1.972	5.718801
31	20	3	1.971	5.913001
32	21	3.1	1.97	6.107001
33	22	3.2	1.969	6.3008
34	23	3.3	1.968	6.494401
35	24	3.4	1.966	6.684401
36	25	3.5	1.965	6.877501
37	26	3.6	1.964	7.070401
38	27	3.7	1.963	7.263101
39	28	3.8	1.962	7.455901

< PMAX DETECTION RESULTS >

Pmax detection results.

(1) Start Time	Test start time
(2) MAX No.	Data number when Pmax is maximum
(3) MAX Voltage	Voltage value when Pmax is maximum
(4) MAX Current	Current value when Pmax is maximum
(5) MAX Power	Power value when Pmax is maximum
(6) Short Circuit	No search
(7) Open Circuit	Test start voltage
(8) DATA Lists	Number of measurement data
No	Measurement data number
VOLT(V)	Measured voltage value
CURR(A)	Measured current value
POWER(W)	Measured power value

Example: Results  
file of MPPT test

	A	B	C
1	(1)Start Time	2018/3/22 19:00	
2	(2)End Time	2018/3/22 19:08	
3	VOLT(V)	CURR(A)	POWER(W)
4	9.501	1.737	16.50324
5	9.501	1.737	16.50324
6	9.501	1.737	16.50324
7	9.501	1.737	16.50324
8	9.548	1.737	16.58488
9	9.548	1.737	16.58488
10	9.524	1.737	16.54319
11	9.547	1.737	16.58314
12	9.57	1.737	16.62309
13	9.57	1.737	16.62309
14	9.583	1.737	16.64567
15	9.583	1.737	16.64567
16	9.577	1.737	16.63525
17	9.582	1.737	16.64394
18	9.587	1.737	16.65262
19	9.587	1.737	16.65262
20	9.589	1.737	16.6561
21	9.589	1.737	16.6561
22	9.589	1.737	16.6561
23	9.589	1.737	16.6561
24	9.589	1.737	16.6561
25	9.588	1.737	16.65436
26	9.588	1.737	16.65436
27	9.588	1.737	16.65436
28	9.588	1.737	16.65436
29	9.588	1.737	16.65436
30	9.588	1.737	16.65436
31	9.588	1.737	16.65436
32	9.588	1.737	16.65436
33	9.588	1.736	16.64477
34	9.587	1.737	16.65262
35	9.587	1.737	16.65262
36	9.587	1.737	16.65262
37	9.588	1.737	16.65436

- (1) Start Time      Test start time
- (2) Stop Time      Test end time
- VOLT(V)            Measured voltage value
- CURR(A)           Measured current value
- POWER(W)        Measured power value

## 4. EXTERNAL CONTROL

### 4-1. Analog Control

The Analog Control subsection describes how to use the frame control ports J1 for voltage or resistance control and the ports J3 for current/voltage monitor output. The control ports J2, located under the frame control ports J1 is used for parallel control. See page 176 (7-4.Frame Control Connector Contacts) for the details the frame control ports J1, J2 and J3.

#### 4-1-1. The ports J1 /J3 Overview

##### 4-1-1-1. The frame control ports J1

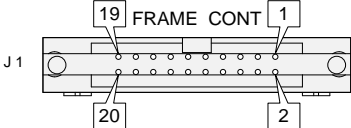
Description	The J1 is a standard Mil 20 pin connector (OMRON XG4A IDC plug). The connector is used for all analog control. The pins are used to determine what mode is used. See the appendix on page 176 to view the contact pin assignment of the J1.
 <b>WARNING</b>	Some pins on the frame control connector have the same potential as the front and rear terminals. To prevent electric shock, ensure the cover for both the J1 and J2 connector.
Pin Assignment	

##### J1 Pin assign

No	Name	No	Name
1	Ext-V In / Ext-R In (+)	2	Ext-V In (+) for +CV
3	A COM	4	SUM I Mon Out
5	PRL In(+)	6	PRL In(-)
7	Ext-Load On(+)	8	I RangeCont1(+)
9	I RangeCont0(+)	10	Ext Alarm In(+)
11	Ext Trigger In(+)	12	A COM
13	Load On Out(+)	14	I Range Status1(+)
15	I Range Status0(+)	16	Alarm Out(+)
17	STATUS COM	18	NC
19	Short Signal Our(+)	20	Short Signal Our(-)

## 4-1-1-2. The ports J3

Description  
LSG-175H/350H  
/1050H Only

The wire connecting with the J3, please use AWG24~28. Please peel the coating of the wire approximately 10mm. Please insert a wire in the terminal hole while pushing the button on the terminal hole of the J3. See the appendix on page 178 to view the contact pin assignment of the J3.



**WARNING**

Please insert the wire in the terminal hole of the J3 deeply. A conductor part of the wire, please do not come in contact with the frame and conductor part of other wire. To prevent electric shock, ensure the cover for the J3.

Pin Assignment

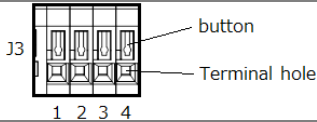

J3 Pin assign

No	Name	No	Name
1	I MON OUT	2	V MON OUT
3	A COM	4	A COM

## 4-1-2. External Voltage Control - Overview

Description	External voltage control of the CC, CR, CV, CP and Cx+CV mode is accomplished using the J1 on the rear panel. An input voltage of 0~10V corresponds to 0% ~ 100% of the rated current (CC mode), rated voltage (CV and Cx+CV mode), or rated power (CP mode). For CR mode, 0V ~ 10V corresponds to the maximum resistance ~ minimum resistance.
Connection	When connecting the external voltage source to the J1, use a ferrite core and use twisted pair wiring.

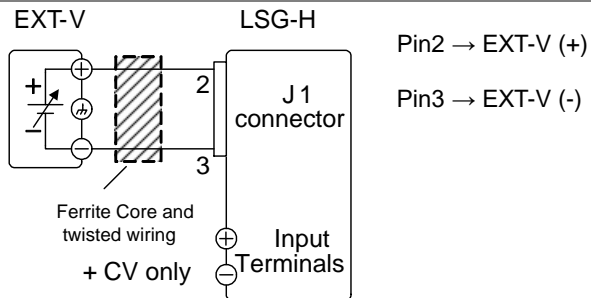
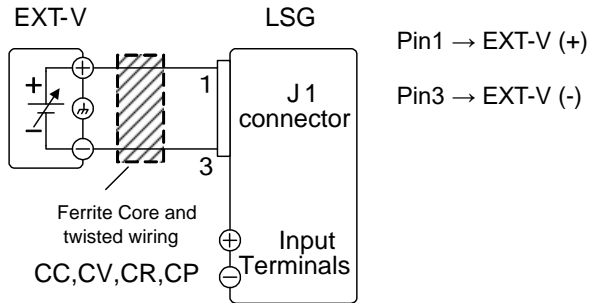

 Note

The input impedance for external voltage control is 10kΩ. Use a stable voltage supply for the external voltage control.

 Caution

When using external voltage control, make sure no more than  $\pm 11\text{V}$  is applied across pins 1 and 3. Exceeding this voltage could damage the LSG Series. Exceeding 11.8V will cause an EXT.OV alarm message to appear which also will reset the voltage output to 0V until the external voltage is reduced back down below 11.8V. Use caution when using pin 3. Pin 3 is directly coupled to the negative input terminal.



### 4-1-3. External Voltage Control – Operation

**Description** External voltage control can be used to control the current, voltage, resistance and power for CC, CR, CV, CP and Cx+CV modes. Configuration for each the operating mode is the same.

**CC Mode** Input current = rated current × (external voltage/10)

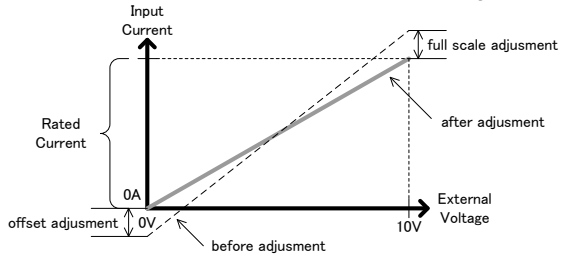

**CR Mode**

Input conductance =  
rated conductance × (external voltage/10)

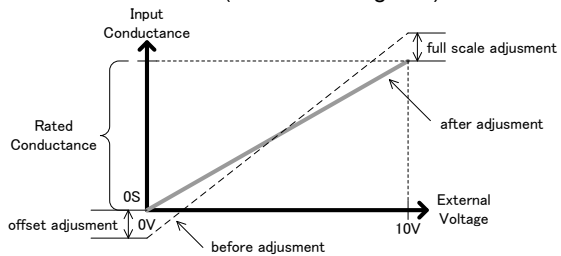

**CV Mode**  
**Cx+CV Mode**

Input voltage = rated voltage × (external voltage/10)

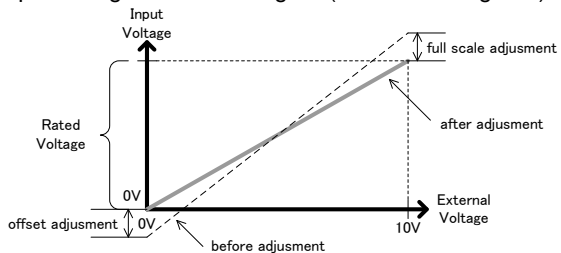

---

CP Mode

Input power = rated power × (external voltage/10)

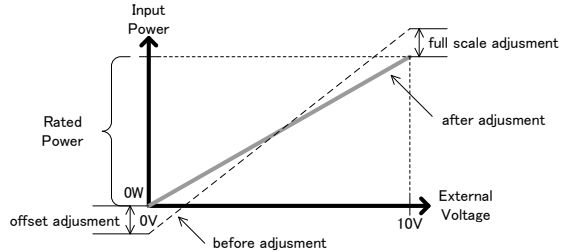

Operation

1. Turn off the power of LSG Series and the Power source.
  2. Connect the external voltage across pins 1 (or 2, +CV only) and 3 of the J1.
  3. Turn on the power of the LSG Series.
  4. Set the operating mode and range. See page 33 (2-1.Basic Operation) for each mode and range.
  5. Press **Main** > *Configure* [F5] > *Next Menu* [F4] > *External* [F3] in order.
  6. When you use External Voltage Control of CC, CR, CV, CP mode. Set the *Control* parameter to V. When you use External Voltage Control of +CV mode. Set the *Control* parameter to V / R / Rinv (Other than OFF). And set +CV *Control* parameter to ON.
- 



Caution

When you set the Control parameter in "OFF", External Voltage Control of +CV mod does not active.

---

The J1 is now ready for external voltage control.

---

#### 4-1-4. Adjust offset and full scale with variable resistor

Variable Resistor  
in rear panel

LSG-175H/350H/  
1050H only

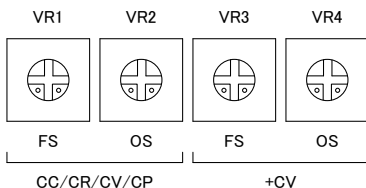

#### Operation

CC, CR, CV, CP  
Mode

1. Apply a voltage of 1V to pin J1-1 based on the level of pin J1-3.
2. Turn VR2 with screwdriver to adjust the value to 10% of the rating in each the operating mode.
3. Apply a voltage of 10V to pin J1-1 based on the level of pin J1-3.
4. Turn VR1 with screwdriver to adjust the value to 100% of the rating in each the operating mode.
5. Apply a voltage of 1V to pin J1-1 based on the level of pin J1-3.
6. Turn VR2 with screwdriver to adjust the value to 10% of the rating in each the operating mode.

Note: Re-adjustment is needed when you use a different the operating mode, current range or voltage range.

Cx+CV Mode

1. Apply a voltage of 1V to pin J1-1 based on the level of pin J1-3.
2. Turn VR4 with screwdriver to adjust the value to 10% of the rating in each +CV mode.
3. Apply a voltage of 10V to pin J1-2 based on the level of pin J1-3.
4. Turn VR3 with screwdriver to adjust the value to 100% of the rating in each +CV mode.
5. Apply a voltage of 1V to pin J1-2 based on the level of pin J1-3.
6. Turn VR4 with screwdriver to adjust the value to 10% of the rating in each +CV mode.

Note: Re-adjustment is needed when you use a different the voltage range.

#### 4-1-5. External Resistance Control - Overview

Description	<p>External resistance control of the CC, CR, CV and CP modes is accomplished using the J1 on the rear panel. A resistance of <math>0\text{k}\Omega\sim 10\text{k}\Omega</math> is used to control the input current, voltage, resistance or power on the LSG Series. The input can be configured to vary in proportion to the external resistance or the inverse. See page 145 (4-1-6. External Resistance Control – Operation) for more details on proportional and inverse resistance control.</p>
Connection	<p>When connecting the external resistance source to the J1 connector, use a ferrite core and use twisted pair wiring.</p>

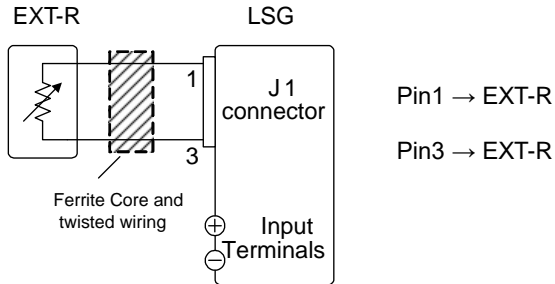

Note

Use resistors with minimum residual resistance of  $50\Omega$  or less.

Note for proportional control:  
Do not use switches that switch between fixed resistances.

Please use continuously variable resistors.  
Exceeding  $11.8\text{k}\Omega$  will cause an EXT.OV alarm message which will reset the voltage output to 0 until the external resistance is reduced back down below  $11.8\text{k}\Omega$ .

#### 4-1-6. External Resistance Control – Operation

**Description** External resistance control can be used to control the current, voltage, resistance and power for CC, CR, CV and CP modes. Configuration for each the operating mode is the same.

**CC Mode** Proportional Control:

Input current = rated current  $\times$  (external resistance/10).

Inverse Control:

Input current = rated current  $\times$   
(1 - external resistance/10).

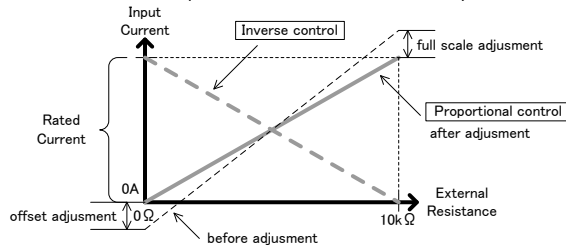

**CR Mode**

Proportional Control:

Input conductance = rated conductance  $\times$   
(external resistance/10).

Inverse Control:

Input conductance = rated conductance  $\times$   
(1 - external resistance/10).

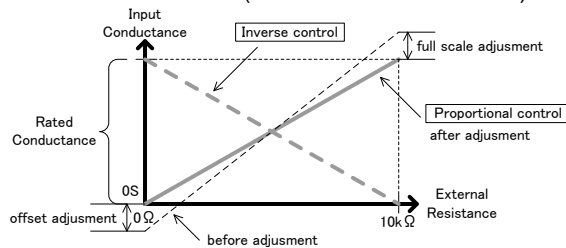

CV Mode

Proportional Control:

$$\text{Input voltage} = \text{rated voltage} \times (\text{external resistance}/10).$$

Inverse Control:

$$\text{Input voltage} = \text{rated voltage} \times (1 - \text{external resistance}/10).$$

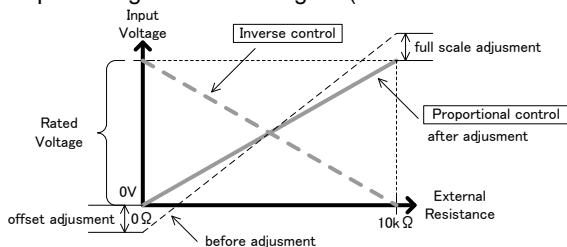

CP Mode

Proportional Control:

$$\text{Input power} = \text{rated power} \times (\text{external resistance}/10).$$

Inverse Control:

$$\text{Input power} = \text{rated power} \times (1 - \text{external resistance}/10).$$

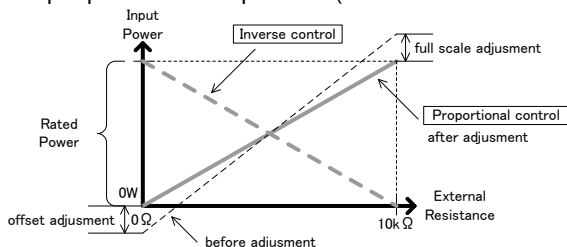

Note

The Inverse Control is recommended for safety reasons. In the event that any of the cables become accidentally disconnected, the current/voltage/power input will drop to the minimum. Under similar circumstances using proportional control, an unexpectedly high input would result.

Operation

1. Turn off the power of LSG Series and the Power source.
2. Connect the external resistance across pins 1 and 3 of the J1 connector.
3. Turn on the power of LSG Series.
4. Set the operating mode and range.  
See page 33 (2-1.Basic Operation) for each mode and range.
5. Press **Main** > *Configure* [F5] > *Next Menu* [F4] > *External* [F3] in order.
6. Set the *Control* to *R* for proportional control or to *Rinv* for inverse control.

The J1 is now ready for external resistance control.

## 4-1-7. Adjust offset and full scale with variable resistor

Variable Resistor  
in rear panel

LSG-175H/350H/  
1050H only

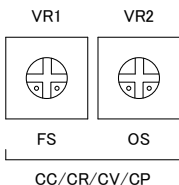

### Operation

Proportional  
control

1. Connect 1kΩ between J1-1 and J1-3.
2. Turn VR2 with screwdriver to adjust the value to 10% of the rating in each the operating mode.
3. Connect 10kΩ between J1-1 and J1-3.
4. Turn VR1 with screwdriver to adjust the value to 100% of the rating in each the operating mode.
5. Connect 1kΩ between J1-1 and J1-3.
6. Turn VR2 with screwdriver to adjust the value to 10% of the rating in each the operating mode.

Note: Re-adjustment is needed when you use a different the operating mode, current range or voltage range.

Inverse  
control

1. Connect 9kΩ between J1-1 and J1-3.
2. Turn VR2 with screwdriver to adjust the value to 10% of the rating in each the operating mode.
3. Connect 1kΩ between J1-1 and J1-3.
4. Turn VR1 with screwdriver to adjust the value to 90% of the rating in each the operating mode.
5. Connect 9kΩ between J1-1 and J1-3.
6. Turn VR2 with screwdriver to adjust the value to 10% of the rating in each the operating mode.

Note: Re-adjustment is needed when you use a different the operating mode, current range or voltage range.

## 4-1-8. Turning the Load On using External Control

Description	The load can be turned on and off with an external switch connected to pins 7 and 12 of the J1 connector.
Pin Inputs	Pin 7 of the J1 connector is internally pulled up to 5V with a 10kΩ resistor when the switch is open. Thus when the switch is open, pin 7 is logically high. When the switch is closed, pin 7 is pulled down to the A COM ground level, making pin 7 logically low.

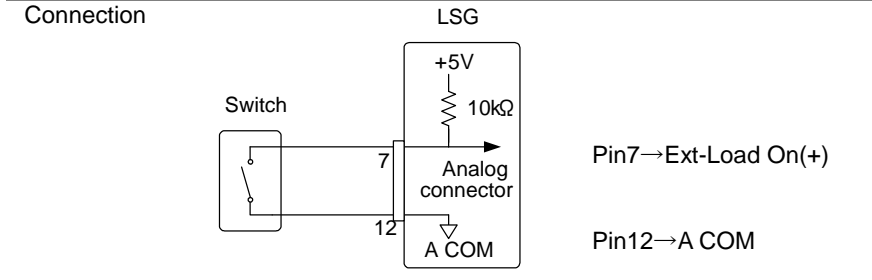

Example	The Load On In setting determines whether the load is turned on when the external switch is closed (low) or open (high).
---------	--

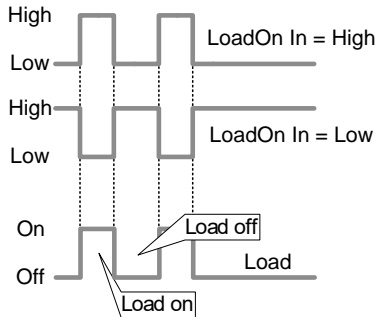

Operation: Configuration	<p>Press <b>Main</b> &gt; <i>Configure</i> [F5] &gt; <i>Next Menu</i> [F4] &gt; <i>External</i> [F3] in order, and set the LoadOn IN setting.</p> <p>Set to Low if you want the load to be turned on when the switch is closed. Set to High if you want the load to turn on when the switch is open.</p>
-----------------------------	--

	<p><b>Note</b></p> <p>When external control is used to turn the load off, the load key cannot be used to turn the load on. However the reverse is not true. If the load has been turned on by external control, the load key can be used to turn the load off.</p>
--	--

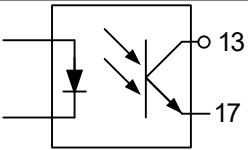

#### 4-1-9. Load On/Off Status

Description	Pins 13 and 17 (Load On Status) of the J1 connector is used to monitor the load status (on or off).
Pin out	The Load On Status pin is a photo-coupled open-collector output. 
Photo-coupler input: 30V max, 8mA, max.	

#### 4-1-10. External Control of the Range

Description	The I Range for the present operating mode can be externally controlled when the I Range is set to high range. The range is changed using pins 8, 9 (Range Cont 1 & 0) and 12 (A Com) of the J1 connector.												
Operation	<ol style="list-style-type: none"> <li>Press <b>Main</b> &gt; <i>Configure</i> [F5] &gt; <i>Next Menu</i> [F4] &gt; <i>External</i> [F3] and set the <i>Control</i> setting to <i>V</i>, <i>R</i> or <i>Riv</i> to enable external control.</li> <li>When externally controlling the range, the pin input combination determines which range is chosen.</li> </ol> <table border="1" style="margin-left: 40px;"> <thead> <tr> <th>I Range</th> <th>Pin 9</th> <th>Pin 8</th> </tr> </thead> <tbody> <tr> <td>H</td> <td>High</td> <td>High</td> </tr> <tr> <td>M</td> <td>High</td> <td>Low</td> </tr> <tr> <td>L</td> <td>Low</td> <td>High</td> </tr> </tbody> </table>	I Range	Pin 9	Pin 8	H	High	High	M	High	Low	L	Low	High
I Range	Pin 9	Pin 8											
H	High	High											
M	High	Low											
L	Low	High											
Pin Inputs	Pins 8 and 9 of the J1 connector are internally pulled up to 5V with a 10kΩ resistor when open. When closed, pin 8 and 9 are pulled down to the A COM ground level.												
Connection	LSG												

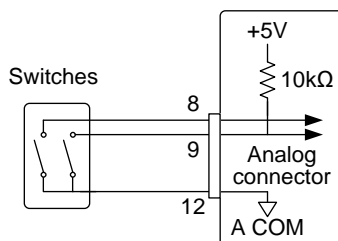

Note

The I Range can only be externally controlled when the I Range has been set to High using the manual operation.

#### 4-1-11. I Range Status

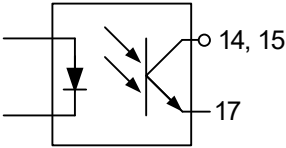
Description	Pins 14 and 15 (Range Status 1&0) of the J1 connector are used to monitor the current range status. The pin out combination determines the current range status.		
	I Range	Pin 14	Pin 15
	H	Off	Off
	M	Off	On
	L	On	Off
Pin out	The Range Status pins are photo-coupled open-collector outputs.		
			
	Photo-coupler input: 30V max, 8mA, max.		

#### 4-1-12. External Trigger Signal

Description	Pins 11 and 12 of the J1 connector are the trigger signal inputs. The trigger signal is used to resume a sequence after a pause. This action is useful to synchronize the execution of a sequence with another device.
Pin inputs	Pin 11 of the J1 connector is internally pulled down to A COM with a 100kΩ resistor. To use the trigger input, an active high 5V TTL pulse of 10us or more is required.
Connection	

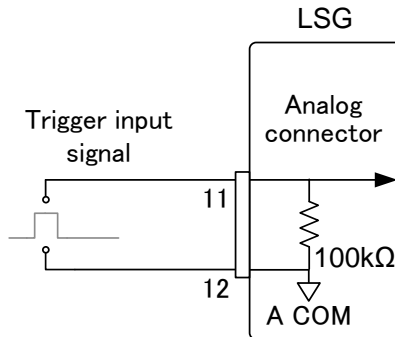

#### 4-1-13. External Alarm input

Description	<p>Pins 10 and 12 of the J1 connector are the alarm inputs. An alarm can be activated/deactivated using external control with the J1 connector. When the alarm is activated, an EXT.AL message is also output. The alarm can be activated by an external device or by a parallel slave unit.</p> <p>The alarm is activated by sending a low-level signal. The operating threshold level is TTL.</p>
Pin Inputs	<p>Pin 10 is internally pulled up to 5V with a 10kΩ resistor when open. When closed, pin 10 is pulled down to the A COM ground level.</p>
Connection	LSG

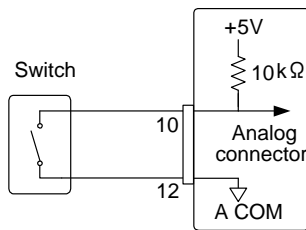

#### 4-1-14. Alarm Status

Description	<p>Pins 16 and 17 of the J1 connector are used to monitor whether the alarm is on or off.</p>
Pin out	<p>The Alarm Status pin is a photo-coupled open-collector output.</p>
<p>Photo-coupler input: 30V max, 8mA, max.</p>	

#### 4-1-15. Short Control

Description	The Short Signal Out pins 19 and 20 of the J1 connector are 30VDC 1A relay contact outputs. These outputs can be used to drive an external relay to physically short the terminal outputs.
Pin Inputs	The Short Signal Out pins are normally opens until the short function is activated.
Connection	

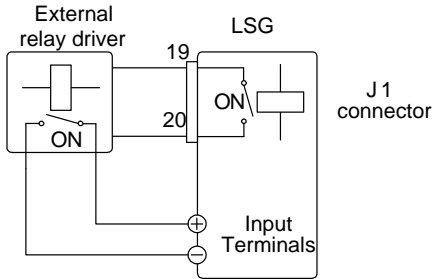

Note

The external relay driver is not a standard accessory. Please provide your own external relay and driver circuit.

## 4-1-16. Monitor Signal Output

### 4-1-16-1. Trigger Signal Output

**Description** The trigger output signal is generated every time a switching operation is performed (i.e., Dynamic mode) or when a Fast or Normal Sequence is executed and the TRIG OUT parameter is enabled. The trigger output signal from TRIG OUT BNC is a 5V pulse of at least 2 $\mu$ s with an impedance of 500 $\Omega$ . The common potential is connected to the chassis potential. The signal threshold level is TTL.

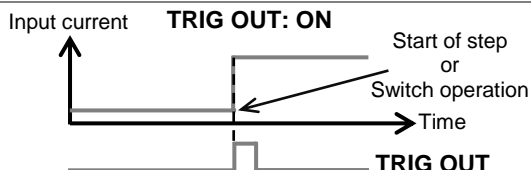

### 4-1-16-2. Current Monitor Output

**Description** The voltage output from the IMON OUT terminal and from the IMON pin on the J3 connector is used to represent the current input level. The V Range used to represent the full scale current range from the IMON OUT terminal and from the IMON pin on the J3 connector depends on the I Range settings.

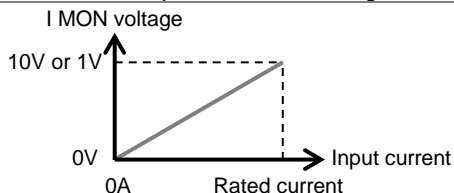

Monitor Connector	I Range	Monitor Output Range
I MON OUT (BNC)	H, L	0 ~ 10V
	M	0 ~ 1V
I MON (J3)	H, L	0 ~ 10V
	M	0 ~ 1V

I MON OUT BNC Connector	The IMON OUT BNC connector outputs a voltage of 0 ~ 10V for the High and Low I Ranges and 0 ~ 1V for the Middle I Range. The common potential is connected to the chassis ground potential.
J3 Connector	The voltage across pins 1 and 3 (or 4) outputs a voltage of 0 -10V for the High and Low I Ranges and 0 - 1V for the Middle I Range. The common potential is connected to A COM (negative load terminal).

#### 4-1-16-3. Voltage Monitor Output

Description	The voltage output from the VMON OUT terminal and from the VMON pin on the J3 connector is used to represent the current input level.
LSG-175H/ 350H/1050H only	The V Range used to represent the full scale current range from the VMON OUT terminal and from the VMON pin on the J3 connector depends on the current range settings.

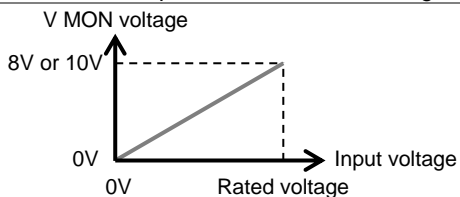

Monitor Connector	V Range	Monitor Output Range
V MON OUT (BNC)	H, L	0 ~ 8V
V MON (J3)	H, L	0 ~ 10V

V MON OUT BNC Connector	The V MON OUT BNC connector outputs a voltage of 0 - 8V for the High and Low V Ranges. The common potential is connected to the chassis ground potential.
J3 Connector	The voltage across pins 2 and 3 (or 4) outputs a voltage of 0 -10V for the High and Low V Ranges. The common potential is connected to A COM (negative load terminal).

## 4-2. Parallel Operation

The LSG Series can be connected in parallel to increase the total power capacity of a single unit. The LSG Series can operate with up to 5 units in parallel. A single unit is designated as a master unit and any other connected units as slaves.

Only units of the same type and rating can be used in parallel or alternatively, the LSG-2100S(H) booster pack can be used as a slave with the LSG-1050(H). When a master unit is used in parallel operation, to ensure stability, the response speed will drop down to 1/2 if it was originally 1/1. You can however, reset the response speed back (or to another value) in the Main>Configure menu.

### 4-2-1. Capacity of DC electronic loads

Model	Single Unit	2 Units	3 Units	4 Units	5 Units
LSG-175H	800V	800V	800V	800V	800V
	8.75A	17.5A	26.25A	35A	43.75A
	175W	350W	525W	700W	875W
LSG-350H	800V	800V	800V	800V	800V
	17.5A	35A	52.5A	70A	87.5A
	350W	700W	1050W	1400W	1750W
LSG-1050H	800V	800V	800V	800V	800V
	52.5A	105A	157.5A	210A	262.5A
	1050W	2100W	3150W	4200W	5250W
LSG-1050H + LSG- 2100HS*	800V	800V	800V	800V	N/A
	157.5A	262.5A	367.5A	472.5A	
	3150W	5250W	7350W	9450W	

\* The LSG-2100SH booster packs do not have a control panel.

They can only be used as slaves with a single LSG-2100SH in parallel.

Model	Single Unit	2 Units	3 Units	4 Units	5 Units
LSG-175	150V	150V	150V	150V	150V
	35A	70A	105A	140A	175A
	175W	350W	525W	700W	875W
LSG-350	150V	150V	150V	150V	150V
	70A	140A	210A	280A	350A
	350W	700W	1050W	1400W	1750W
LSG-1050	150V	150V	150V	150V	150V
	210A	420A	630A	1680A	1050A
	1050W	2100W	3150W	4200W	5250W
LSG-1050 +LSG-2100S Boosters*	150V	150V	150V	150V	N/A
	630A	1050A	1470A	1890A	
	3150W	5250W	7350W	9450W	

\* The LSG-2100S booster packs do not have a control panel. They can only be used as slaves with a single LSG-1050 in parallel.

## 4-2-2. Connection

Description	The frame control ports J1 and J2 connectors are used for control during parallel operation. Up to 5 units can be used in parallel.
 Note	Only the rear panel terminals can be used for parallel operation, the front panel terminals have a lower current rating and thus should not be used for parallel operation.

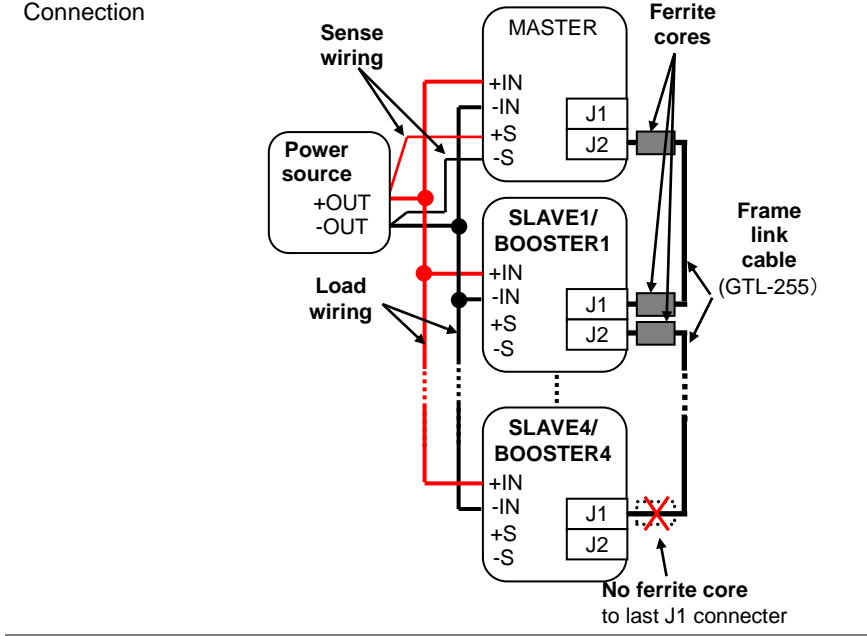

 Cautions	<p>Only the rear terminals can be used for parallel connections.</p> <p>Make sure all connections are correct before turning on the load. Incorrect connections could damage the units.</p> <p>Only units of the same type and rating can be used in parallel (except for when the LSG-2100S(H) booster pack is used with the LSG-1050(H)).</p> <p>Ensure that wiring of sufficient gauge is used when using parallel connections.</p> <p>If using remote sense, only connect the master to the voltage sense terminals.</p>
--	--



### 4-2-3. Configuration

Description	When using the multiple units in parallel all the basic settings are adopted from the master unit.
Operation (1/2)	<ol style="list-style-type: none"> <li>1. Make sure all load units are turned off.</li> <li>2. Make sure the power source is turned off.</li> <li>3. Connect the load units to the power source. Ensure the wire gauge is sufficient to handle the increase in current.</li> <li>4. Connect the Master unit to the slave units via the J1 and J2 connectors*. Use the GTL-255 frame link cables Connect from: M:J2⇔S1/B1:J1, S1/B1:J2⇔S2/B2:J1, S2/B2:J2 ... (M: Master, S: Slave, B: Booster, GTL-255: ⇔) Remove one ferrite core from the last frame link cable. Remove the ferrite core that is closest to the J1 connector on the last slave unit or booster. See (page 156) the diagram below for details.</li> <li>5. Turn the load units on.</li> <li>6. On the designated master unit, press <b>Main</b> &gt; <i>Configure</i> [F5] &gt; <i>Next Menu</i> [F4] &gt; <i>Parallel</i> [F1] in order.</li> <li>7. Set the unit to <i>Master</i> with the <i>Operation</i> setting.</li> <li>8. Assign the number of attached slave units or booster units with the <i>Parallel</i> and <i>Booster</i> settings. When connect the same model to parallel, set number by <i>Parallel</i> setting. A maximum of 5 units can be used in parallel. When connect LSG-1050H and LSG-2100SH to parallel, set number by <i>Booster</i> setting. A maximum of 4 boosters can be used with a single, acting as a master unit.</li> </ol>

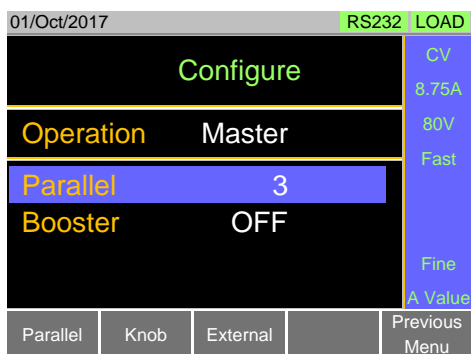

Operation  
(2/2)

9. On the slave units, press **Main** > *Configure* [F5] > *Next Menu* [F4] > *Parallel* [F1] in order, and set *Operation* to *Slave*.

01/Oct/2017		RS232 LOAD	
Configure		CV	
Operation Slave		8.75A	
Parallel 3		80V	
Booster OFF		Fast	
		Fine	
		A Value	
Parallel	Knob	External	Previous Menu

When in Slave mode, all keys are locked, except for the Scroll wheel and Enter key.



Caution

\*Failing to remove the last ferrite core from the GTL-255 cable may reduce the stability of the units when used in parallel.

#### 4-2-4. Turning the Load On

Description Operating the LSG Series in parallel operation is the same as for single units.



Note

When using the units in parallel, the load line inductance could be increased or the stability of the units could be reduced. It may be necessary to reduce the response speed setting to increase stability.

- Operation
1. Turn the slave and master units on.
  2. Set the operation mode and settings on the master unit. The master's settings will be used by the slave units.
  3. Turn the load on from the Master unit. All measurements will be displayed and updated on the Master unit only.

#### 4-2-5. Disable Parallel operation

Description	To disable parallel operation, each unit must be set as a "Master".
Operation	<ol style="list-style-type: none"><li>1. Turn the power off on all the units and remove the GTL-255 frame link cables.</li><li>2. Turn the power back.</li><li>3. On each unit, press <b>Main</b> &gt; <i>Configure</i> [F5] &gt; <i>Next Menu</i> [F4] &gt; <i>Parallel</i> [F1] in order.</li><li>4. Set the unit to <i>Master</i> with the <i>Operation</i> setting.</li><li>5. Turn the <i>Parallel</i> and <i>Booster</i> settings to <i>off</i>.</li></ol>

#### 4-2-6. Connection using option plate

Description	This section explains how to connect in parallel using the option plate.
-------------	--

To connect one LSG-1050/ LSG-1050H and four LSG-2100S/SH, use PEL-005 to PEL-009 as shown below.

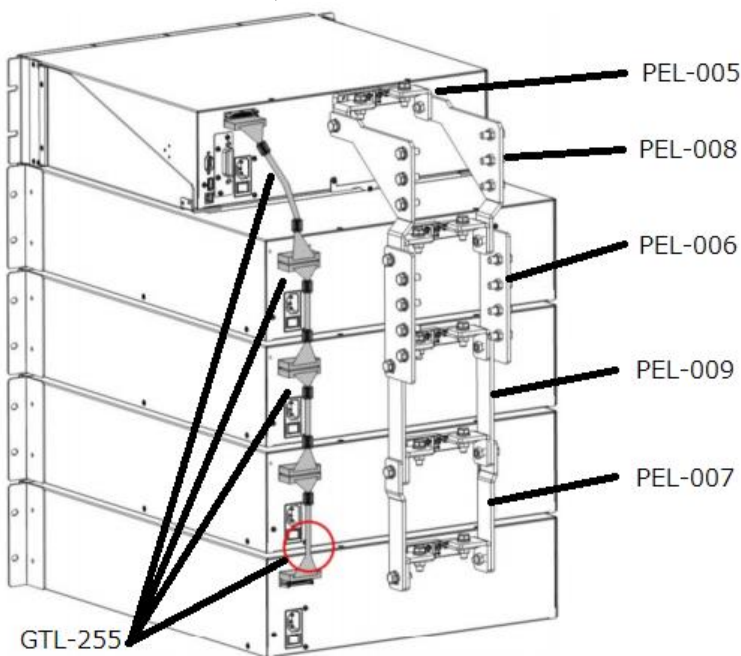



## 5. REMOTE CONTROL



This chapter describes basic configuration of IEEE488.2 based remote control. For a command list, refer to the programming manual, downloadable from TEXIO TECHNOLOGY website, [www.texio.co.jp](http://www.texio.co.jp)

### 5-1. Interface Configuration

#### 5-1-1. Configure to USB Remote Interface

USB configuration	PC side connector	Type A, host
	LSG Series side connector	Rear panel Type B, slave
	Speed	2.0 (full speed)
	USB Class	USB CDC ACM
 Note	If the COM port is not recognized when connecting via USB, install the USB-CDC device driver. Please copy the downloaded USB driver from our HP to the appropriate folder.	
	Operation	<ol style="list-style-type: none"> <li>1. Connect the USB cable to the rear panel USB B port.</li> </ol>
		Utility
	<ol style="list-style-type: none"> <li>2. Press  &gt;  &gt; <i>Interface</i> [F3] in order, and set the Interface setting to <i>USB</i>.</li> </ol>	
	<ol style="list-style-type: none"> <li>3. If there is a request of the USB driver PC to recognize the instrument, specify the USB-CDC driver.</li> </ol>	
	<ol style="list-style-type: none"> <li>4. In the device manager of PC, if it is not assigned to the serial port is the instrument, please specify the USB-CDC driver updates driver.</li> </ol>	
	<ol style="list-style-type: none"> <li>5. Please check the port number in Device Manager.</li> </ol>	

#### 5-1-2. Configure RS-232C

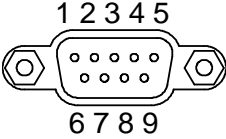
RS-232C Configuration	Connector	DB-9, Male
	Baud Rate	2400, 4800, 9600, 19200, 38400
	Stop Bit	1, 2
	Parity	None, Odd, Even
Operation	<ol style="list-style-type: none"> <li>1. Connect an RS-232C cable from the PC to the rear panel RS232 port.</li> </ol>	Utility
	<ol style="list-style-type: none"> <li>2. Press  &gt;  &gt; <i>Interface</i> [F3] in order, and set the Interface setting to <i>RS232</i>.</li> </ol>	
	<ol style="list-style-type: none"> <li>3. Set the <i>Baud Rate</i>, <i>Stop Bit</i> and <i>Parity</i> settings.</li> </ol>	
Pin Assignment		2: RxD (Receive data) 3: TxD (Transmit data) 5: GND 4, 6 ~ 9: No connection

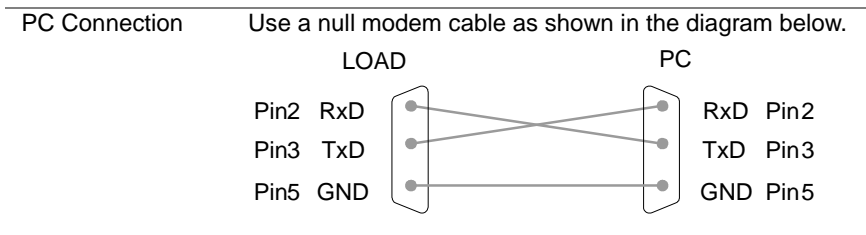

### 5-1-3. Configure GP-IB Interface

To use GP-IB, the optional GP-IB port must be installed. See page 173 for installation details (7-2.GP-IB Installation).



Operation	<ol style="list-style-type: none"> <li>1. Ensure the LSG Series is off before proceeding.</li> <li>2. Connect a GP-IB cable from a GP-IB controller to the GP-IB port on the LSG Series.</li> <li>3. Turn the LSG Series on.</li> </ol>																																								
	<p style="text-align: center;">Utility</p> <ol style="list-style-type: none"> <li>4. Press <input type="button" value="Shift"/> &gt; <input type="button" value="Help"/> &gt; <i>Interface</i> [F3] in order, and set the Interface setting to <i>GP-IB</i>.</li> <li>5. Set the GP-IB address. GP-IB address 0~30</li> </ol>																																								
GP-IB constraints	<p>Maximum 15 devices altogether, 20m cable length, 2m between each device.          Unique address assigned to each device.          At least 2/3 of the devices turned On.          No loop or parallel connection.</p>																																								
Pin Assignment	<div style="text-align: center;"> </div> <table border="1"> <thead> <tr> <th>Pin</th> <th>Signal</th> <th>Pin</th> <th>Signal</th> </tr> </thead> <tbody> <tr> <td>1-4</td> <td>Data I/O 1-4</td> <td>13-16</td> <td>Data I/O 5-8</td> </tr> <tr> <td>5</td> <td>EOI</td> <td>17</td> <td>REN</td> </tr> <tr> <td>6</td> <td>DAV</td> <td>18</td> <td>Ground (DAV)</td> </tr> <tr> <td>7</td> <td>NRFD</td> <td>19</td> <td>Ground (NRFD)</td> </tr> <tr> <td>8</td> <td>NDAC</td> <td>20</td> <td>Ground (NDAC)</td> </tr> <tr> <td>9</td> <td>IFC</td> <td>21</td> <td>Ground (IFC)</td> </tr> <tr> <td>10</td> <td>SRQ</td> <td>22</td> <td>Ground (SRQ)</td> </tr> <tr> <td>11</td> <td>ATN</td> <td>23</td> <td>Ground (ATN)</td> </tr> <tr> <td>12</td> <td>SHIELD Ground</td> <td>24</td> <td>Single GND</td> </tr> </tbody> </table>	Pin	Signal	Pin	Signal	1-4	Data I/O 1-4	13-16	Data I/O 5-8	5	EOI	17	REN	6	DAV	18	Ground (DAV)	7	NRFD	19	Ground (NRFD)	8	NDAC	20	Ground (NDAC)	9	IFC	21	Ground (IFC)	10	SRQ	22	Ground (SRQ)	11	ATN	23	Ground (ATN)	12	SHIELD Ground	24	Single GND
Pin	Signal	Pin	Signal																																						
1-4	Data I/O 1-4	13-16	Data I/O 5-8																																						
5	EOI	17	REN																																						
6	DAV	18	Ground (DAV)																																						
7	NRFD	19	Ground (NRFD)																																						
8	NDAC	20	Ground (NDAC)																																						
9	IFC	21	Ground (IFC)																																						
10	SRQ	22	Ground (SRQ)																																						
11	ATN	23	Ground (ATN)																																						
12	SHIELD Ground	24	Single GND																																						

## 5-1-4. Configure LAN Interface

LAN 設定	Connector	RJ-45 AutoMDIx
	Speck	IPv4, Socket, HTTP
	DHCP	ON/OFF
	IP Address	000.000.000.000 - 254.255.255.255
	Subnet Mask	000.000.000.000 - 255.255.255.255
	Gateway	000.000.000.000 - 254.255.255.255
	Port	Socket:2268、HTTP:80

- Operation
1. Attach the LAN option to the LSG, connect the LAN cable, and turn on the power. Check that the LED next to the LAN connector flashes.

Utility

2. Press  >  > *Interface* [F3], and set the Interface setting to Ethernet.
3. Set the DHCP settings.
4. If DHCP is off, set the IP address, subnet mask, and gateway.

01/Oct/2017		Ethernet LOAD		
<b>Interface</b>		Ethernet		
Connection status		Online		
MAC	00-80-2f-20-4e-23			
DHCP	ON			
IP Address	192.168.1.100			
Subnet Mask	255.255.255.0			
System Info	Load	Interface	Time Set	Other

01/Oct/2017		Ethernet LOAD		
<b>Connection status</b>		Online		
MAC	00-80-2f-20-4e-23			
DHCP	ON			
IP Address	192.168.1.100			
Subnet Mask	255.255.255.0			
Gateway	192.168.1.1			
System Info	Load	Interface	Time Set	Other



Note

Set the IP address according to the IEEE802.3 standard.

We cannot provide support for IP settings.

If connecting to an existing network, have the network administrator specify the address.

When connecting a controller such as a PC directly to the LSG, turn off DHCP and specify a fixed IP.

### 5-1-5. RS-232C/USB Remote Control Function Check

---

Functionality check      Invoke a terminal application such as PuTTY or RealTerm. For RS-232C and USB, set the COM port, baud rate, stop bit, data bit, and parity accordingly. To check the COM port number and associated port settings, see the Device Manager in the PC. For Windows:

*Control panel → System → Hardware tab*

---



Note

If you are not familiar with using a terminal application to send/receive remote commands from the serial port or via a USB connection, please page 163 (5-1-5. Using RealTerm to Establish a Remote Connection) for more information.

---

Operation

Run this query command via the terminal after the instrument has been configured for RS-232C (page 160) / USB (page 160) remote control.  
\*IDN?

This should return the Manufacturer, Model number, Serial number, and Firmware version in the following format.

TEXIO,LSG-H SERIES,XXXXXXXXXXXX, V.X.X.X.X

---



Note

For further details, please see the programming manual, available on the TEXIO TECHNOLOGY web site [www.texio.co.jp](http://www.texio.co.jp)

---

### 5-1-6. Using RealTerm to Establish a Remote Connection

Description

RealTerm is a terminal program that can be used to communicate with a device attached to the serial port of a PC or via an emulated serial port via USB.

The following instructions apply to version 1.99.0.27.

Even though RealTerm is used as an example to establish a remote connection, any terminal program can be used that has similar functionality.

---



Note

RealTerm can be downloaded on Sourceforge.net free of charge.

For more information please see <http://realterm.sourceforge.net/>

---

Operation  
(1/2)

1. Download RealTerm and install according to the instructions on the RealTerm website.
2. Connect the LSG Series via USB (page 160) or via RS-232C (page 160).
3. If using RS-232C, make note of the configured baud rate, stop bits and parity.
4. Go to the Windows device manager and find the COM port number for the connection.  
For example, go to the Control Panel > Device Manager.  
Double click the *Ports* icon to reveal the connected serial port devices and the COM port for the each connected device.  
If using USB, the baud rate, stop bit and parity settings can be viewed by right-clicking connected device and selecting the *Properties* option.
5. Start RealTerm from Desktop or Menu.
6. After RealTerm has started, click on the *Port* tab. Enter the *Baud*, *Parity*, *Data bits*, *Stop bits* and *Port* number configuration for the connection. The *Hardware Flow Control*, *Software Flow Control* options can be left at the default settings. Press *Open* to connect to the LSG Series.

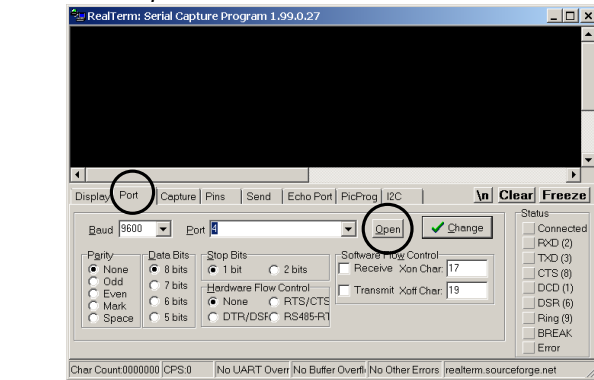



Operation  
(1/2)

- Click on the *Send* tab.  
In the *EOL* configuration, check on the *+CR* and *+LF* check boxes.  
Enter the query:  
*\*idn?*  
Click on *Send ASCII*.

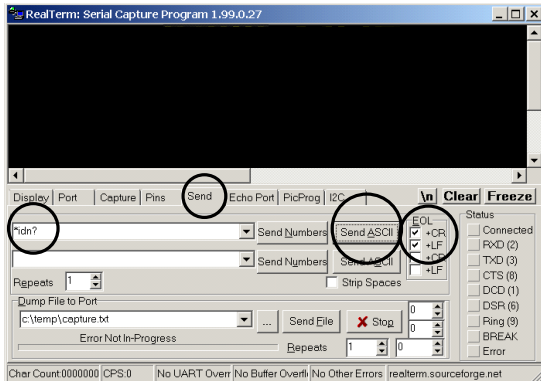

- The terminal display will return the following:  
*TEXIO, LSG-XXXXH,EXXXXXXXX, VX.XX.XXX*  
(manufacturer, model, serial number, version)
- If RealTerm fails to connect to the LSG Series, please check all the cables and settings and try again.

## 5-1-7. GP-IB Function Check

Functionality check	Please use the National Instruments Measurement & Automation Controller software to confirm GP-IB functionality. See the National Instrument website, <a href="http://www.ni.com">http://www.ni.com</a> NI-488.2 library is required for operation check.
---------------------	--



Note

Operation	<ol style="list-style-type: none"> <li>1. Start the NI Measurement and Automation Explorer (MAX) program. Using Windows, press:  <i>Start&gt;All Programs&gt;National Instruments&gt;Measurement &amp; Automation</i></li> <li>2. From the Configuration panel access; <i>My System&gt;Devices and Interfaces&gt;GP-IB0</i></li> <li>3. Press the <i>Scan for Instruments</i> button.</li> <li>4. In the <i>Connected Instruments</i> panel the LSG Series should be detected as <i>Instrument 0</i> with the address the same as that configured on the LSG Series.</li> <li>5. Double click the <i>Instrument 0</i> icon.</li> </ol>
-----------	---

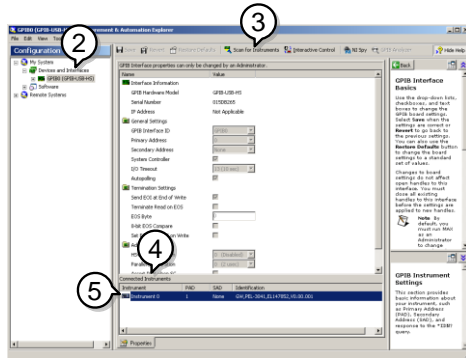

6. Click on <i>Communicate with Instrument</i> .
7. In the <i>NI-488.2 Communicator</i> window, ensure <i>*IDN?</i> is written in the <i>Send String</i> text box. Click on the <i>Query</i> button to send the <i>*IDN?</i> query to the instrument.

8. The *String Received* text box will display the query return:  
**TEXIO, LSG-XXXXH,EXXXXXXXXX, VX.XX.XXX**  
 (manufacturer, model, serial number, version)

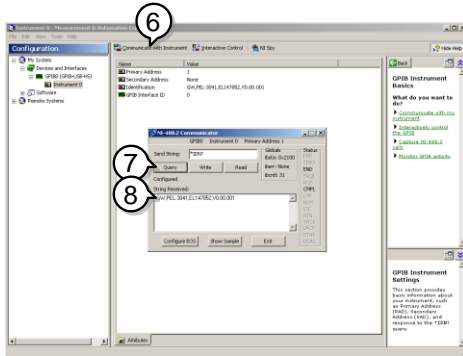

The function check is complete.

## 5-1-8. LAN Function Check (HTTP)

Operation

To check LAN communication, specify the IP address set in the LSG from the PC web browser and display the page.

If the IP is 192.168.1.100, specify `http://192.168.1.100` as the address and open it.

- Status Information
- Network Configuration
- Dimensions
- Operating Area



[Visit Our Site](#)

[Support](#) | [Contact Us](#)

Welcome Page

Network Configuration

Figure of Dimensions

Operating Area

### LSG Series Web Control Pages

Thanks For Your Using.

Use the left menu to select the features you need.

More How-to  
Please refer to user manual.



### System Information

Manufacturer:	TEXIO
Serial Number:	0000000
Description:	TEXIO LSG-350H
Firmware Version:	V1.08
Hostname:	P-000001
IP Address:	192.168.1.100
Subnet Mask:	255.255.0.0
Gateway:	192.168.1.1
DNS:	0.0.0.0
MAC Address:	00-10-20-30-40-50
DHCP State:	ON
VISA TCP/IP Connect String:	TCPIP0::192.168.1.100::2268::SOCKET

Copyright 2019 © TEXIO TECHNOLOGY CORPORATION All Rights Reserved.

## 5-1-9. LAN Function Check(Socket)

**Background** To test the socket server functionality, National Instruments Measurement and Automation Explorer can be used. Required NI-VISA

- Functionality check**
1. To start NI Measurement and Automation Explorer (MAX), click the NI-MAX icon on the desktop.
  2. From the Configuration panel access *My System>Devices and Interfaces>Network Devices*
  3. Press *Add New Network Device>Visa TCP/IP Resource...*

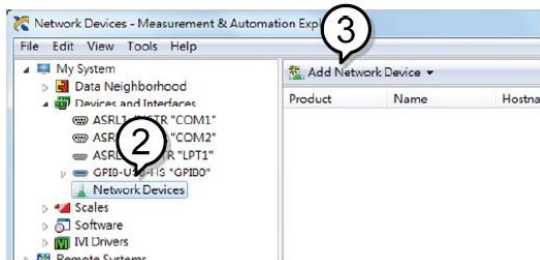

4. Select *Manual Entry of Raw Socket* from the popup window.

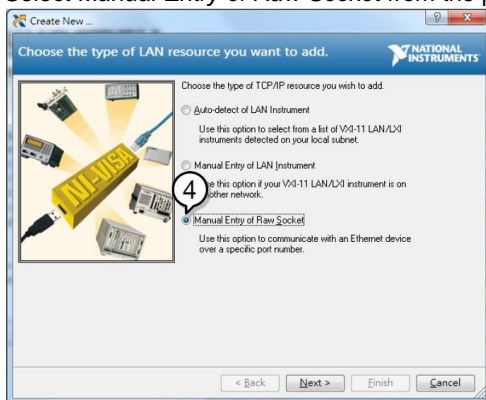

5. Enter the IP address and the port number of the PFR-100. The port number is fixed at 2268.
6. Click the *Validate* button.
7. A popup will appear if a connection is successfully established.
8. Click *Next*.

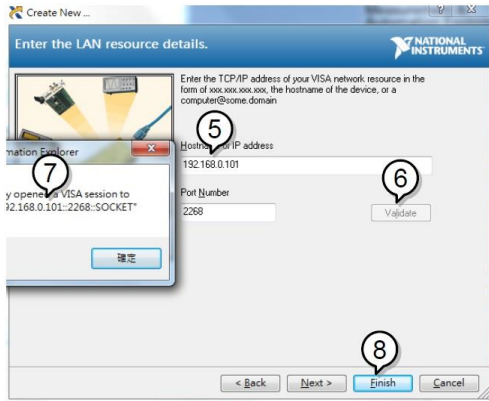

9. Next configure the Alias (name) of the PFR-100 connection.  
Example : LSG\_DC1

10. Click *finish*.

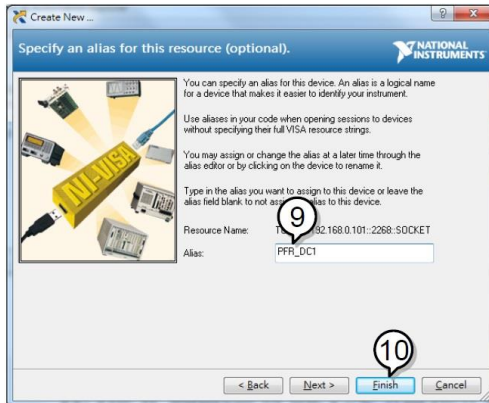

11. The IP address of the PFR-100 will now appear under Network Devices in the configuration panel. Select this icon now.

12. Press *Open VISA Test Panel*.

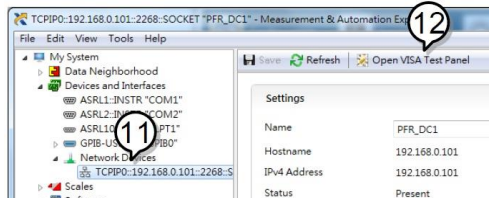

13. Click the *Configuration* icon.

14. Click on *I/O Settings*.

15. Make sure the *Enable Termination Character* check box is checked, and the terminal character is \n (Value: xA).

16. Click *Apply Changes*.

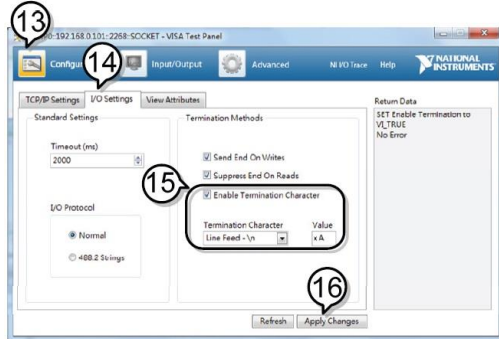

17. Click the *Input/Output* icon.

18. Enter *\*IDN?* in the *Select or Enter Command* dialog box if it is not already.

19. Click the *Query* button.

20. The *\*IDN?* query will return the Manufacturer, model name, serial number and firmware version in the dialog box.

TEXIO LSG-350,000000,V1.28

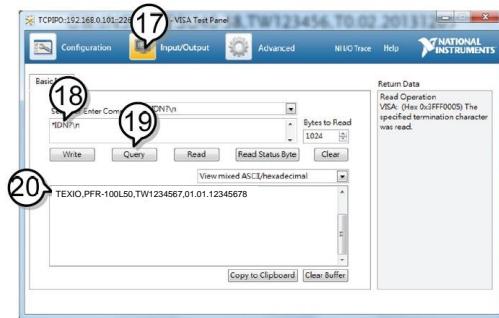

## 6. FAQ

- The load voltage indicated on the load module is below expected.
- The front panel keys are not working.
- The load won't turn on.
- The performance does not match the specification

### **The load voltage indicated on the load module is below expected.**

Ensure the load leads are as short as possible, twisted and use the appropriate wire gauge. Ensure that remote sense is used, this can help alleviate the voltage drop across the load the leads.

### **The front panel keys are not working.**

Check to make sure that the key lock has not been activated. LOCK will be shown on the panel when the screen is locked. Press Shift + Clear (Lock) to unlock the keys.

### **The load won't turn on.**

If you are using the load key to try to turn the load on and the load won't turn on, it is possible that external control is activated and that the LoadOn In setting is set to low. See page 148 (4-1-8.Turning the Load On using External Control) for details.

### **The performance does not match the specification.**

Make sure the device is powered on for at least 30 minutes, within +20°C~+30°C. This is necessary to stabilize the unit to match the specification.

For more information, contact your local dealer or  
TEXIO TECHNOLOGY at [www.texio.co.jp](http://www.texio.co.jp)

## 7. APPENDIX

### 7-1. Replacing the Dust Filter

---

Description	The dust filter should be replaced twice a year. Not replacing the filter will reduce performance and may cause the LSG Series to malfunction.
-------------	---

---

- |           |  |
|-----------|--|
| Procedure | 1. Turn the LSG Series off completely at the rear panel power switch.<br>Gently lift the grill up from the bottom. |
|-----------|--|

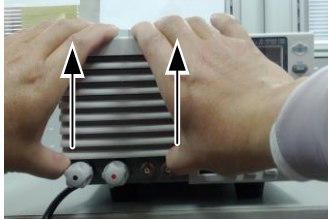

- |  |  |
|--|--|
|  | 2. Remove the filter from the grill and replace with part number: PEL-010. |
|--|--|

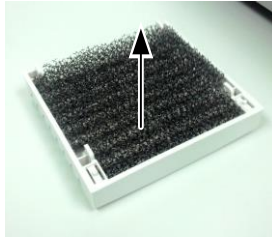



## 7-2. GP-IB/LAN Installation

Description	GP-IB and LAN are the extra optional. The following instructions describe how to install the optional GP-IB card: PEL-004, LAN card: PEL-018 if necessary.
Procedure	<ol style="list-style-type: none"><li data-bbox="356 304 669 328">1. Turn off the LSG Series.</li><li data-bbox="356 333 930 384">2. Remove the two screws holding the cover on the option bay.</li><li data-bbox="356 389 930 440">3. Slide the optional card onto the rails in the option bay.</li><li data-bbox="356 445 807 474">4. Re-screw the screws back into place.</li></ol>

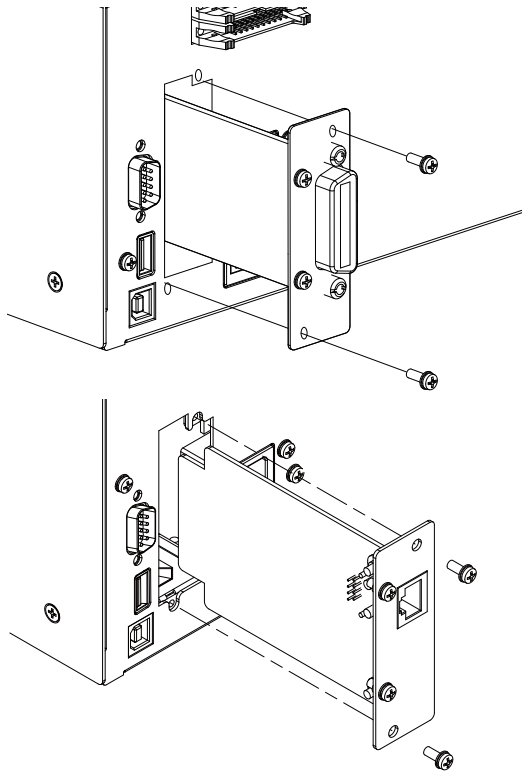

### 7-3. Default Settings

The following default settings are the factory configuration settings.

Main Settings		
Item	Panel Settings	Setup Memory Settings (all 100 sets)
Current(CC)	0 A	0 A
Conductance(CR)	0 S	0 S
Voltage(CV)	Rated value	Rated value
Wattage(CP)	0 W	0 W
+CV	OFF	OFF
Current range	H	H
Voltage range	800 V /150V	800 V /150V
Load on/off	Load off	Load off
Operation mode	CC	CC
Slew rate	Maximum value of H range	Maximum value of H range
Preset memories	Settings above in each mode	Settings above in each mode

Main > Configure > Protection		
Item	Panel Settings	Setup Memory Settings (all 100 sets)
OCP Level	Maximum value	Maximum value
OCP Setting	LIMIT	LIMIT
OPP Level	Maximum value	Maximum value
OPP Setting	LIMIT	LIMIT
UVP value	OFF	OFF
OVP value	OFF	OFF

Main > Configure > Other		
Item	Panel Settings	Setup Memory Settings (all 100 sets)
Soft Start	OFF	OFF
Von Voltage	0.0V	0.0V
Von Latch	ON	ON
Von Delay	2.0ms	2.0ms
Response	1/1	1/1
Count Time (elapsed time display)	OFF	OFF
Cut Off Time	OFF	OFF
CR Unit	mS	mS
Dyna. Level	Value	Value
Dyna. Time	T1/T2	T1/T2
Mem.Recall	Direct	Direct
Short Key	Toggle	Toggle

Main > Configure > Go-NoGo		
Item	Panel Settings	Setup Memory Settings (all 100 sets)
SPEC. Test	OFF	OFF
Delay Time	0.0s	0.0s
Entry Mode	Value	Value
High	Maximum Voltage / Maximum Current	Maximum Voltage / Maximum Current
Low	Minimum Voltage / Minimum Current	Minimum Voltage / Minimum Current

Main > Configure > Next Menu > Parallel		
Item	Panel Settings	Setup Memory Settings (all 100 sets)
Operation	Master	Master
Parallel	OFF	OFF
Booster	OFF	OFF

Main > Configure > Next Menu > Knob		
Item	Panel Settings	Setup Memory Settings (all 100 sets)
Status	Step	Step
CCH Step	Resolution	Resolution
CCM Step	Resolution	Resolution
CCL Step	Resolution	Resolution
CRH Step	Resolution	Resolution
CRM Step	Resolution	Resolution
CRL Step	Resolution	Resolution
CVH Step	Resolution	Resolution
CVL Step	Resolution	Resolution
CPH Step	Resolution	Resolution
CPM Step	Resolution	Resolution
CPL Step	Resolution	Resolution

Main > Configure > Next Menu > External		
Item	Panel Settings	Setup Memory Setting (all 100 sets)
Control	OFF	OFF
+CV Control	OFF	OFF
LoadOn IN	OFF	OFF

## 7-4. Frame Control Connector Contacts

Frame control ports J1 (LSG-175H/LSG-350H/LSG-1050H)

Pin name	Pin number	Description
Ext-V In / Ext-R In (+)	1	Used for voltage/resistance control of CC, CR, CV and CP mode.  0V to 10V corresponds to 0% to 100% of the rated current (CC mode), rated voltage (CV mode), or rated power (CP mode). 0V to 10V corresponds to the maximum resistance to minimum resistance (CR mode)  0Ω to 10kΩ corresponds to 0% to 100% or 100% to 0% of the rated current (CC mode), rated voltage (CV mode), or rated power (CP mode). 0Ω to 10kΩ corresponds to maximum resistance to minimum resistance or minimum resistance to maximum resistance (CR mode)
Ext-V In (+) for +CV	2	Used for voltage control of Cx+CV mode. 0V to 10V corresponds to 0% to 100% of the rated voltage.
A COM	3	Connected to the negative load input terminal on the rear panel.
SUM I Mon Out	4	Used during master/slave operation. Connected to SUM I MON of the J2 connector.
PRL In(+)	5	Used during master/slave operation. Connected to PRL OUT+ of the J2 connector.
PRL In(-)	6	Used during master/slave operation. Connected to PRL OUT- of the J2 connector.
Ext-Load On(+)	7	Turns on the load with low (or high) TTL level signal. Pulled up the internal circuit to 5V using 10kΩ.
I RangeCont1(+)	8	External range switch input <sup>*1 *2</sup>
I RangeCont0(+)	9	Pulled up the internal circuit to 5V using 10kΩ.
Ext Alarm In(+)	10	Activates alarm with low TTL level signal input. Pulled up the internal circuit to 5V using 10kΩ.
Ext Trigger In(+)	11	When paused, clears the pause when a low level TTL signal is applied for 10us or longer. Pulled down the internal circuit to A COM using 100kΩ.
A COM	12	Connected to the negative load input terminal on the rear panel.
Load On Out(+)	13	Turns on when load is on. Open collector output by a photo-coupler. <sup>*4</sup>

I Range Status1(+)	14	Range status output. *3 Open collector output by a photo-coupler.*4
I Range Status0(+)	15	
Alarm Out(+)	16	Turns on when an alarm (OVP, OCP, OPP, OTP, RVP, or UVP) is activated or when an external alarm is applied. Open collector output by a photo-coupler.*4
STATUS COM	17	STATUS signal common for pins 13 to 16.
NC	18	
Short Signal Our (+)	19	Relay contact output (30VDC/1A)
Short Signal Our (-)	20	

\*1 Valid only when the front panel settings are H range.

*2	RANGE CONT 0	RANGE CONT 1
H range	1	1
M range	1	0
L range	0	1

*3	RANGE STATUS 0	RANGE STATUS 1
H range	OFF	OFF
M range	OFF	ON
L range	ON	OFF

\*4 The maximum applied voltage of the photo-coupler is 30V; the maximum current is 8mA.

## J2 Connector

Pin name	Pin number	Description
N.C.	1	
N.C.	2	
N.C.	3	
SUM I MON	4	Connect to SUM I MON of the J1 connector.
PRL OUT+	5	Used during master/slave operation. Connected to PRL IN+ of the J1.
PRL OUT-	6	Used during master/slave operation. Connected to PRL IN- of the J1.
LOAD ON/OFF CONT	7	"Turns on the load with low (or high) TTL level signal. Pulled up the internal circuit to 5V using 10kΩ."
SLAVE RANGE CONT 0	8	Used during master/slave operation. Connected to RANGE CONT 1 of the J1 connector.
SLAVE RANGE CONT 0	9	Used during master/slave operation. Connected to RANGE CONT 0 of the J1 connector.
N.C.	10	
N.C.	11	
A COM	12	Connected to the negative load input terminal on the rear panel.
N.C.	13	
N.C.	14	
N.C.	15	
ALARM INPUT	16	Activates an alarm with high (or low) TTL level signal input. Pulled up the internal circuit to 5V.
A COM	17	Connected to the negative load input terminal.
N.C.	18	
A COM	19	Connected to the negative load input terminal.
+15V	20	Controls the on/off of the load booster power
ALARM INPUT		(Cannot be used for multiple purposes).

## Monitor Out ports J3 (LSG-175H/LSG-350H/LSG-1050H)

Pin name	Pin number	Description
I MON	1	Current monitor output 10V f.s (H/L range) and 1V f.s (M range)
V MON	2	Voltage monitor output 10V f.s
A COM	3	Connected to the negative load input terminal.
A COM	4	Connected to the negative load input terminal.

### Frame control ports J1 (LSG-2100SH)

Pin name	Pin number	Description
N.C.	1	
N.C.	2	
A COM	3	Connected to the negative load input terminal.
SUM I MON	4	Connected to SUM I MON of the J2 connector.
PRL IN+	5	Connected to PRL OUT+ of the J2 connector.
PRL IN-	6	Connected to PRL OUT- of the J2 connector.
LOAD ON/OFF CONT	7	"Turns on the load with low (or high) TTL level signal. Pulled up the internal circuit to 5V using 10kΩ."
RANGE CONT 0	8	"External range switch input" <sup>*1</sup> <sup>*2</sup>
RANGE CONT 0	9	Pulled up the internal circuit to 5V using 10kΩ."
ALARM INPUT	10	Activates an alarm with high (or low) TTL level signal input. Pulled up by the internal circuit to 5V.
N.C.	11	
A COM	12	Connected to the negative load input terminal on the rear panel.
N.C.	13	
N.C.	14	
N.C.	15	
ALARM STATUS	16	Turns on when an alarm (OVP, OCP, OPP, OTP, RVP, or UVP) is activated or when an external alarm is applied. Open collector output by a photocoupler. <sup>*3</sup>
STATUS COM	17	STATUS signal common for pins 16.
N.C.	18	
A COM	19	Connected to the negative load input terminal on the rear panel.
+15V	20	Controls the on/off of the load booster power (cannot be used for multiple purposes).

\*1 Valid only when the front panel settings are H range.

*2	RANGE CONT 0	RANGE CONT 1
H range	1	1
M range	1	0
L range	0	1

\*3 The maximum applied voltage of the photo-coupler is 30V; the maximum current is 8mA.

Frame control ports J2 (LSG-2100S/SH)

Pin name	Pin number	Description
N.C.	1	
N.C.	2	
N.C.	3	
SUM I MON	4	Connect to SUM I MON of the J1 connector.
PRL OUT+	5	Used during master/slave operation. Connected to PRL IN+ of the J1.
PRL OUT-	6	Used during master/slave operation. Connected to PRL IN- of the J1 connector.
LOAD ON/OFF CONT	7	"Turns on the load with low (or high) TTL level signal. Pulled up the internal circuit to 5V using 10kΩ."
SLAVE RANGE CONT 1	8	Used during master/slave operation. Connected to RANGE CONT 1 of the J1 connector.
SLAVE RANGE CONT 0	9	Used during master/slave operation. Connected to RANGE CONT 0 of the J1 connector.
N.C.	10	
N.C.	11	
A COM	12	Connected to the negative load input terminal on the rear panel.
N.C.	13	
N.C.	14	
N.C.	15	
ALARM INPUT	16	Activates an alarm with high (or low) TTL level signal input. Pulled up the internal circuit to 5V.
A COM	17	Connected to the negative load input terminal.
N.C.	18	
A COM	19	Connected to the negative load input terminal.
+15V	20	Controls the on/off of the load booster power (Cannot be used for multiple purposes).



## 7-5. Operating Mode Description

### 7-5-1. CC Mode

#### CC Mode

When the unit is set to CC mode it will operate as a constant current load when connected to a constant voltage source. This means the unit will sink a designated amount of current, up to the rated power level, regardless of the voltage. This is illustrated below.

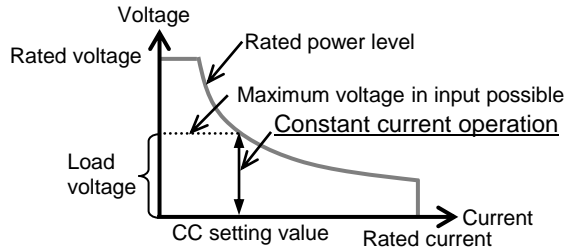

#### CC+CV Mode

The unit will act as constant current operation after the load voltage is greater than the +CV setting value. At the +CV setting value, the unit works as a constant voltage operation. This mode effectively creates a voltage ceiling before the unit operates in CC mode. The diagram below illustrates this.

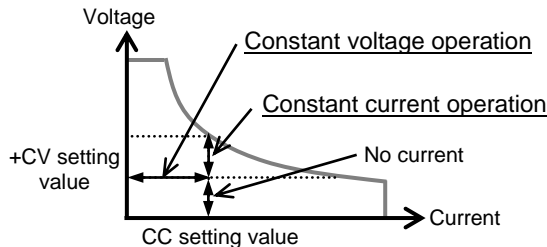

Note that when the load voltage is less than the +CV setting value, no current will flow due to very high impedance.

## 7-5-2. CR Mode

### CR Mode

When the unit is set to CR mode it will operate as a constant resistance load when connected to a constant voltage (CV) or constant current (CC) source.

This means the unit will maintain a set resistance, up to the rated power, regardless of the load voltage or current.

CV source : Load current = Load voltage / CR setting value

CC source : Load voltage = Load current x CR setting value

This is illustrated below.

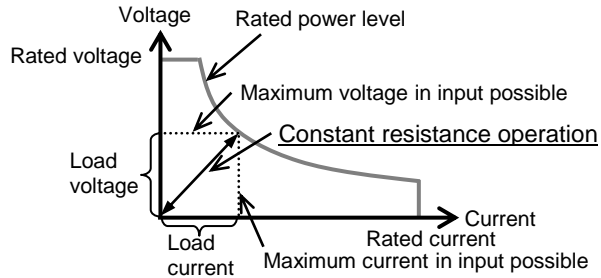

### CR+CV Mode

The unit will act as constant resistive operation after the input voltage is greater than the +CV setting value. At the +CV setting value, the unit works as a constant voltage operation. This mode effectively creates a voltage ceiling before the unit operates in CR mode.

The diagram below illustrates this.

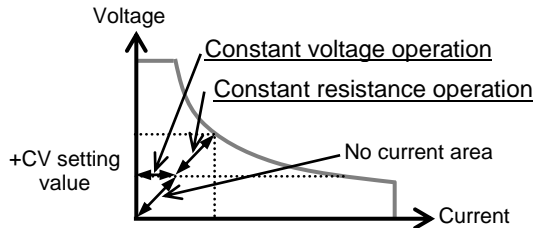

Note that when the load voltage is less than the +CV setting value, no current will flow due to very high impedance.

### 7-5-3. CP Mode

#### CP Mode

When the unit is set to CP mode it will operate as a constant power operation when connected to a constant voltage source.

This means the unit will maintain a set CP setting value, up to the rated current or voltage level, regardless of the load voltage. When load voltage changes, the unit responds by changing the current load to maintain the set power level accordingly ( $P=I \times V$ ).

This is illustrated below.

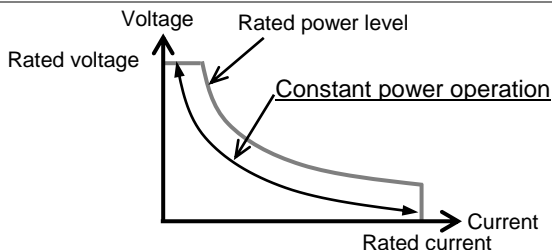

#### CP+CV Mode

The unit will act as a constant power operation after the load voltage is greater than the +CV setting value.

At the +CV setting value, the unit works as a constant voltage operation. This mode effectively creates a voltage ceiling before the unit operates in CP mode.

The diagram below illustrates this.

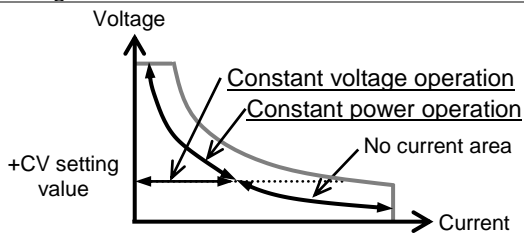

Note that when the load voltage is less than the +CV setting value, no current will flow due to very high impedance.

## 7-5-4. CV Mode

### CV Mode

When the unit is set to CV mode it will operate as a constant voltage operation when connected to a constant current source.

This means the unit will maintain the CV setting value, up to the rated power, regardless of the input current.

This is illustrated below.

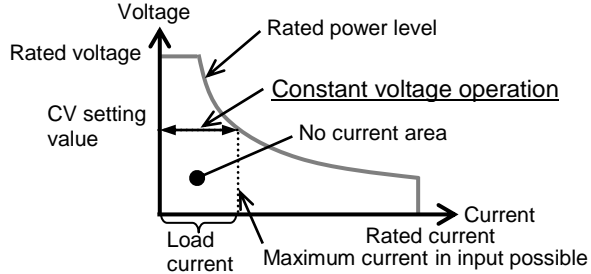

Note that when the load voltage is less than the +CV setting value, no current will flow due to very high impedance.

## 7-6. LSG Operating Area

### 7-6-1. LSG-175

#### H Range

High Range Chart

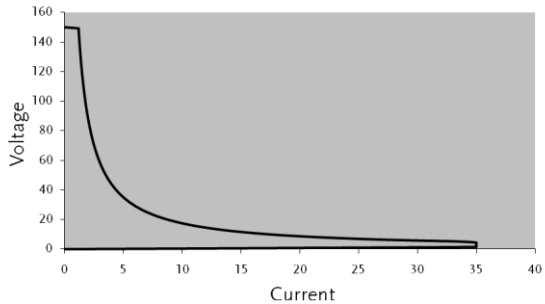

---

M Range

Middle Range Chart

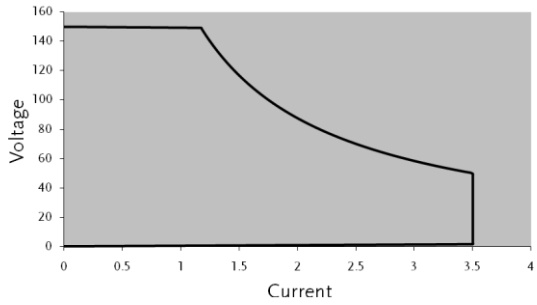

---

L range

Low Range Chart

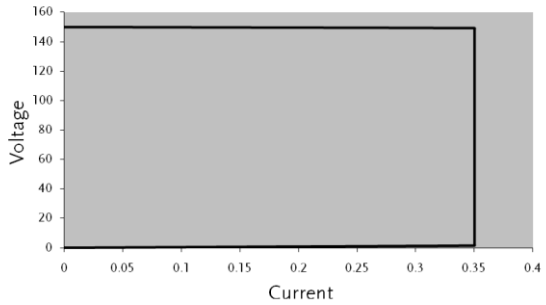

---

7-6-2. LSG-350

H range

High Range Chart

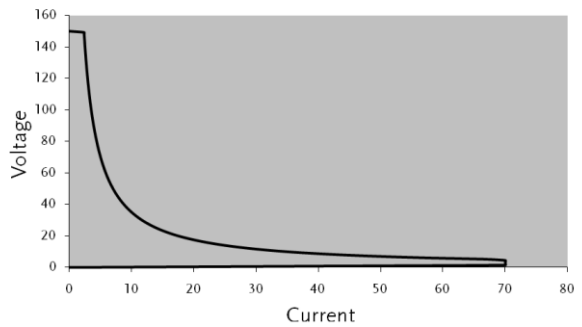

---

M Range

Middle Range Chart

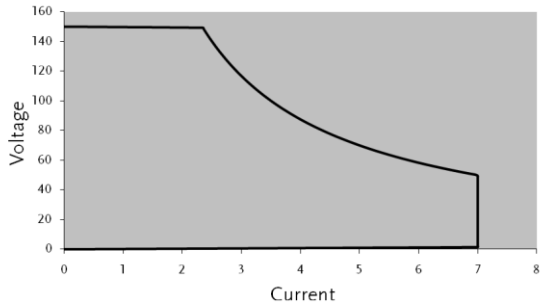

---

L Range

Low Range Chart

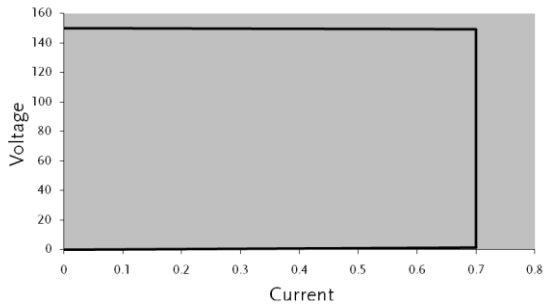

---

7-6-3. LSG-1050

H Range

High Range Chart

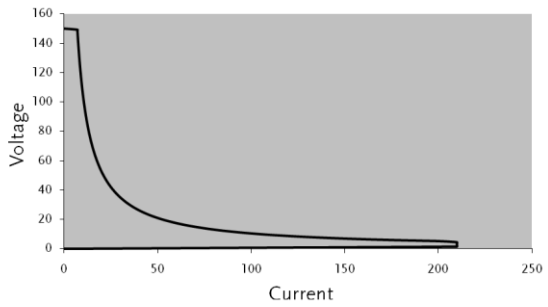

---

M Range

Low Range Chart

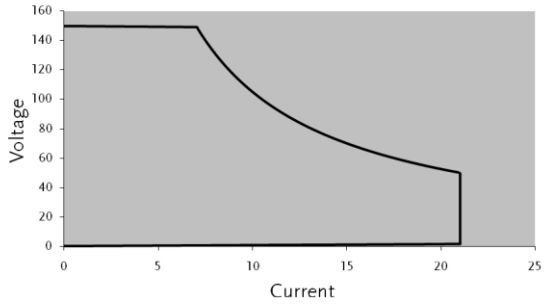

---

L Range

Low Range Chart

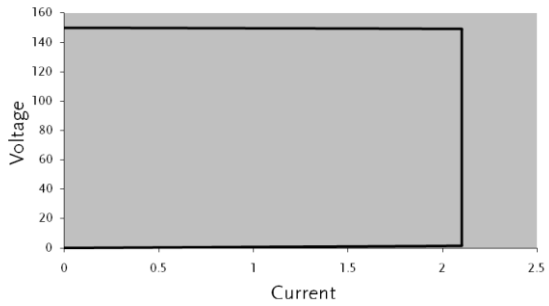

---

7-6-4. LSG-2100S

High Range Chart

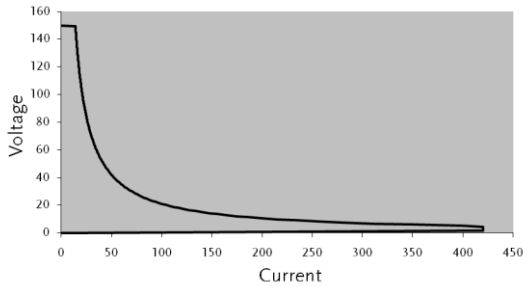

# 7-7. LSG-H Operating Area

## 7-7-1. LSG-175H

### H Range

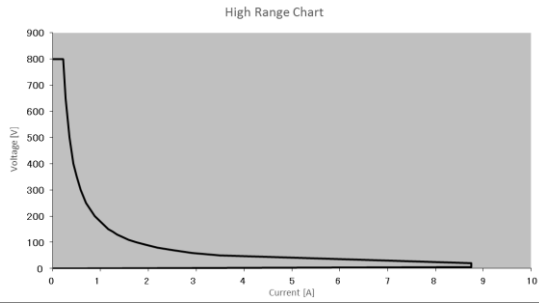

### M Range

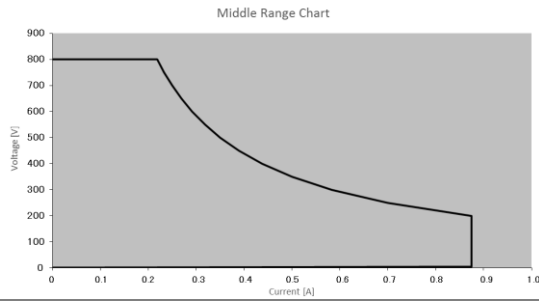

### L Range

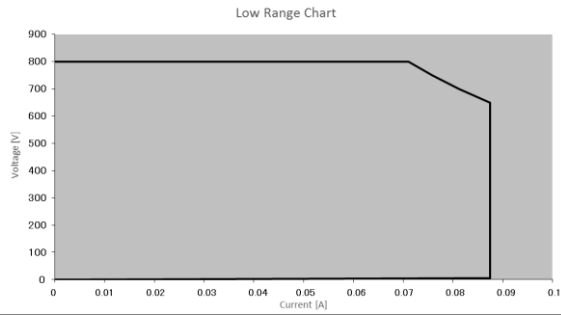



## 7-7-2. LSG-350H

### H Range

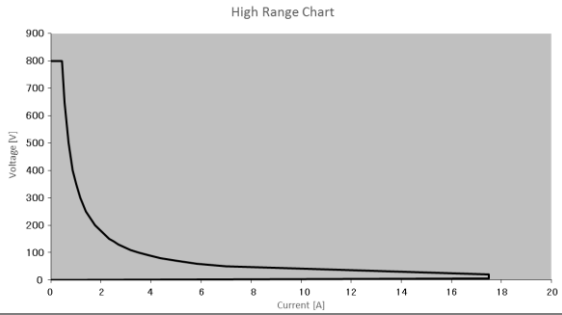

### M Range

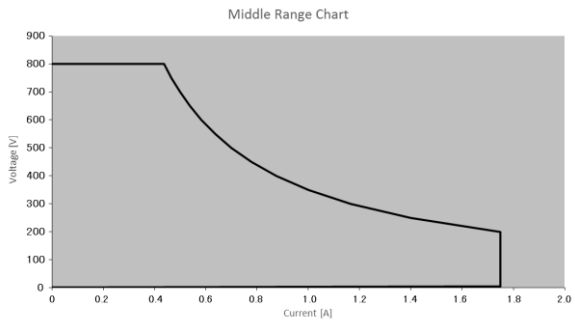

### L Range

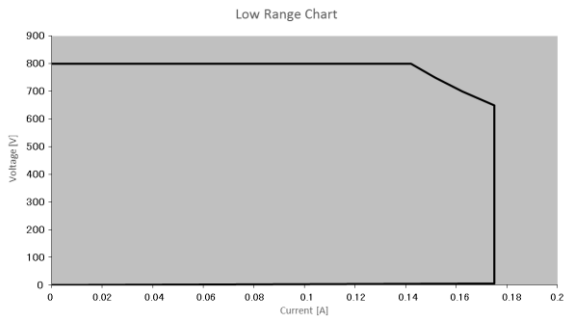

# 7-7-3. LSG-1050H

## H Range

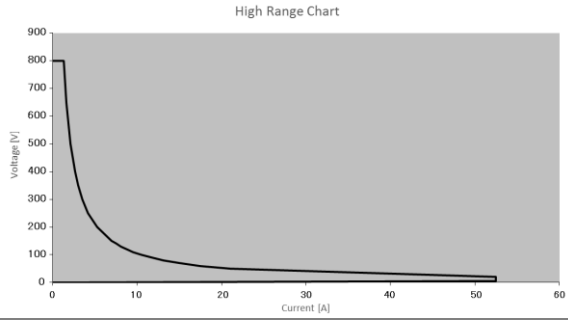

## M Range

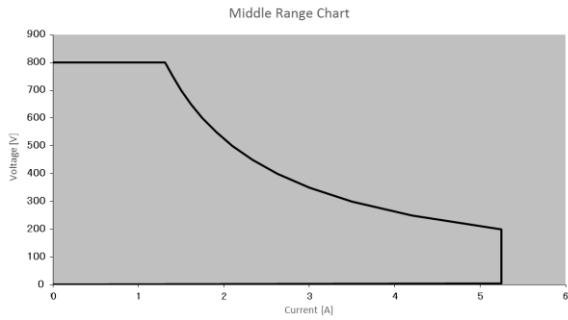

## L Range

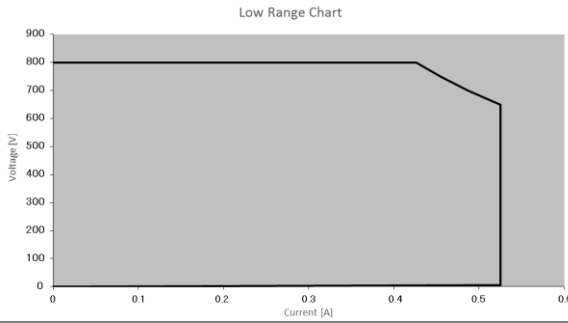

## 7-7-4. LSG-2100H

### H Range

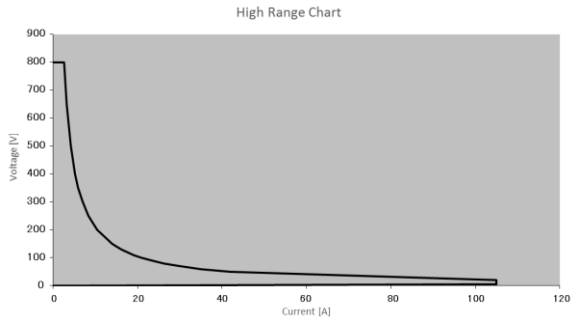

### M Range

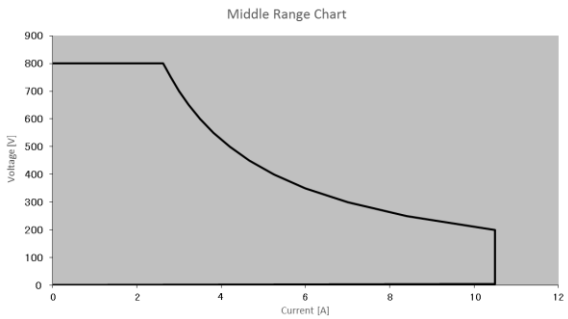

### L Range

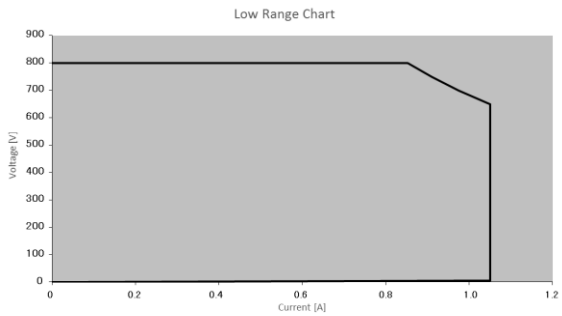

## 7-8. LSG Series Specifications

The specifications apply when the LSG Series is powered on for at least 30 minutes to warm-up to a temperature of 20°C to 30°C, unless specified otherwise. All specifications apply when using the rear panel terminals.

If the front panel terminals are used or if operating with long cables, remote sense must be connected to the terminals.

In parallel mode: All operation/settings/resolution specifications are xN. This does not include voltage settings and measured values.

The **maximum** slew rate settings also don't change.

N = Number of units in parallel (same model)

N = 1 + 2 x Number of units in parallel (Booster)

### 7-8-1. Rating

Model	LSG-175	LSG-350	LSG-1050
Operating Voltage	1.5V~150V	1.5V~150V	1.5V~150V
Current	35A	70A	210A
Power	175W	350W	1050W

### 7-8-2. Rating(LSG-2100S)

Voltage	1.5V-150V
Current	420A (H and M Range only)
Power	2100W
Current Setting Accuracy	±(1.2% of set + 1.1% of f.s) M range applies to the full scale of H range.

### 7-8-3. CC Mode

Model	LSG-175	LSG-350	LSG-1050
Operating Range			
H Range	0A~35A	0A~70A	0A~210A
M Range	0A~3.5A	0A~7A	0A~21A
L Range	0A~0.35A	0A~0.7A	0A~2.1A
Setting Range			
H Range	0A~36.75A	0A~73.5A	0A~220.5A
M Range	0A~3.675A	0A~7.35A	0A~22.05A
L Range	0A~0.3675A	0A~0.735A	0A~2.205A
Default Setting			
H Range	0A	0A	0A
M Range	0A	0A	0A
L Range	0A	0A	0A

Resolution			
H Range	1mA	2mA	10mA
M Range	0.1mA	0.2mA	1mA
L Range	0.01mA	0.02mA	0.1mA
Accuracy of Setting			
H, M Range	$\pm(0.2\% \text{ of set} + 0.1\% \text{ of f.s.}^{*1}) + V_{in}^2/500 \text{ k}\Omega$		
L Range	$\pm(0.2\% \text{ of set} + 0.1\% \text{ of f.s.}) + V_{in}^2/500 \text{ k}\Omega$		
Parallel Operation	$\pm(1.2\% \text{ of set} + 1.1\% \text{ of f.s.}^{*3})$		
Input Voltage Variation <sup>*4</sup>			
H Range	2mA+ $V_{in}^2/500\text{k}\Omega$	4mA+ $V_{in}^2/500\text{k}\Omega$	10mA+ $V_{in}^2/500\text{k}\Omega$
M Range	2mA+ $V_{in}^2/500\text{k}\Omega$	4mA+ $V_{in}^2/500\text{k}\Omega$	10mA+ $V_{in}^2/500\text{k}\Omega$
L Range	0.1mA+ $V_{in}^2/500\text{k}\Omega$	0.2mA+ $V_{in}^2/500\text{k}\Omega$	0.6mA+ $V_{in}^2/500\text{k}\Omega$
Ripple			
RMS <sup>*5</sup>	3mA	5mA	20mA <sup>*7</sup>
P-P <sup>*6</sup>	30mA	50mA	100mA <sup>*7</sup>

\*1 Full scale of H range

\*2  $V_{in}$ : input terminal voltage of electronic load

\*3 M range applies to the full scale of H range

\*4 When the input voltage is varied from 1.5V to 150V at a current of rated power/150V

\*5 Measurement frequency bandwidth: 10Hz to 1MHz

\*6 Measurement frequency bandwidth: 10Hz to 20MHz

\*7 At measurement current of 100A

#### 7-8-4. CR Mode

Model	LSG-175	LSG-350	LSG-1050
Operating Range <sup>*1</sup>			
H Range	23.3336S~400uS (42.857m $\Omega$ ~2.5k $\Omega$ )	46.6672S~800uS (21.428m $\Omega$ ~1.25k $\Omega$ )	140.0016S~2.4mS (7.1427m $\Omega$ ~416.6667 $\Omega$ )
M Range	2.33336S~40uS (428.566m $\Omega$ ~25k $\Omega$ )	4.6667S~80uS (214.28m $\Omega$ ~12.5k $\Omega$ )	14.0001S~242.4uS (71.427m $\Omega$ ~4.16667k $\Omega$ )
L Range	0.233336S~4uS (4.28566 $\Omega$ ~250k $\Omega$ )	0.46667S~8uS (2.1428 $\Omega$ ~125k $\Omega$ )	1.40001S~24.24uS (714.27m $\Omega$ ~41.6667k $\Omega$ )
Setting Range			
H Range	24.5S~0S (40.8163m $\Omega$ ~OPEN)	49.0S~0S (20.408m $\Omega$ ~OPEN)	147.000S~0S (6.8027m $\Omega$ ~OPEN)
M Range	2.45S~0S (408.1633m $\Omega$ ~OPEN)	4.90S~0S (204.08m $\Omega$ ~OPEN)	14.70000S~0S (68.0272m $\Omega$ ~OPEN)
L Range	0.245S~0S (4.08163 $\Omega$ ~OPEN)	0.490S~0S (2.0408 $\Omega$ ~OPEN)	1.4000S~0S (680.2721m $\Omega$ ~OPEN)
Resolution			
H Range	400uS	800uS	2.4mS
M Range	40uS	80uS	240uS
L Range	4uS	8uS	24uS

Accuracy of Setting <sup>*2</sup>	
H, M Range	$\pm(0.5 \% \text{ of set}^{*3} + 0.5 \% \text{ of f.s.}^{*4}) + V_{in}^{*5}/500 \text{ k}\Omega$
L Range	$\pm(0.5 \% \text{ of set}^{*3} + 0.5 \% \text{ of f.s.}) + V_{in}^{*5}/500 \text{ k}\Omega$
*1 Siemens[S] = Input current[A] / Input voltage[V] = 1 / resistance[Ω]	
*2 Converted value at the input current. At the input current. It is not applied for the condition of the parallel operation.	
*3 set = $V_{in} / R_{set}$	
*4 f.s. = Full scale of High Range	
*5 $V_{in}$ = Input terminal voltage of electronic load	

### 7-8-5. CV Mode

Model	LSG-175	LSG-350	LSG-1050
Operating Range			
H Range	1.5V~150V	1.5V~150V	1.5V~150V
L Range	1.5V~15V	1.5V~15V	1.5V~15V
Setting Range			
H Range	0V~157.5V		
L Range	0V~15.75V		
Resolution			
H Range	10mV		
L Range	1mV		
Accuracy of Setting <sup>*1</sup>			
H, L Range	$\pm(0.1 \% \text{ of set} + 0.1 \% \text{ of f.s.})$		
Input current variation <sup>*2</sup>			
H Range	50mV		
L Range	12mV		
*1 At the sensing point during remote sensing under the operating range of the input voltage. It is also applied for the condition of the parallel operation.			
*2 With respect to a change in the current of 10 % to 100 % of the rating at an input voltage of 1.5 V (during remote sensing).			

### 7-8-6. CP Mode

Model	LSG-175	LSG-350	LSG-1050
Operating Range			
H Range	17.5W~175W	35W~350W	105W~1050W
M Range	1.75W~17.5W	3.5W~35W	10.5W~105W
L Range	0.175W~1.75W	0.35W~3.5W	1.05W~10.5W
Setting Range			
H Range	0W~183.75W	0W~367.5W	0W~1102.5W
M Range	0W~18.375W	0W~36.75W	0W~110.25W
L Range	0W~1.8375W	0W~3.675W	0W~11.025W
Resolution			
H Range	10mW	10mW	100mW
M Range	1mW	1mW	10mW
L Range	0.1mW	0.1mW	1mW

**Accuracy of Setting<sup>\*1</sup>**

$$\pm(0.6 \% \text{ of set} + 1.4 \% \text{ of f.s.}^{*2}) + \text{Vin}^{*3} / 500\text{k}\Omega$$

\*1 It is not applied for the condition of the parallel operation.

\*2 M range applies to the full scale of H range.

\*3 Vin = Input terminal voltage of electric load.

**7-8-7. Slew Rate**

Model	LSG-175	LSG-350	LSG-1050
<b>Setting Range (CC Mode)</b>			
H Range	2.5mA/us~2.5A/us	5mA/us~5A/us	16mA/us~16A/us
M Range	250uA/us~250mA/us	500uA/us~500mA/us	1.6mA/us~1.6A/us
L Range	25uA/us~25mA/us	50uA/us~50mA/us	160uA/us~160mA/us
<b>Setting Range (CR Mode)</b>			
H Range	250uA/us~250mA/us	500uA/us~500mA/us	1.6mA/us~1.6A/us
M Range	25uA/us~25mA/us	50uA/us~50mA/us	160uA/us~160mA/us
L Range	2.5uA/us~2.5mA/us	5uA/us~5mA/us	16uA/us~16mA/us
<b>Resolution</b>			
Resolution	1mA	2mA	6mA
Setting	250mA/us~2.5A/us	500mA/us~5A/us	1.6A/us~16A/us
Resolution	100uA	200uA	600uA
Setting	25mA/us~250mA/us	50mA/us~500mA/us	160mA/us~1.6A/us
Resolution	10uA	20uA	60uA
Setting	2.5mA/us~25mA/us	5mA/us~50mA/us	16mA/us~160mA/us
Resolution	1uA	2uA	6uA
Setting	250uA/us~2.5mA/us	500uA/us~5mA/us	1.6mA/us~16mA/us
Resolution	100nA	200nA	600nA
Setting	25uA/us~250uA/us	50uA/us~500uA/us	160uA/us~1.6mA/us
Resolution	10nA	20nA	60nA
Setting	2.5uA/us~25uA/us	5uA/us~50uA/us	16uA/us~160uA/us
<b>Accuracy of Setting<sup>*1</sup></b>			
$\pm(10\% \text{ of set} + 5\text{us})$			

\*1 Time to reach from 10 % to 90 % when the current is varied from 2 % to 100 % (20 % to 100 % in M range) of the rated current.

**7-8-8. Meter**

Model	LSG-175	LSG-350	LSG-1050
<b>Voltmeter</b>			
H Range	0.00V~150.00V	0.00V~150.00V	0.00V~150.00V
L Range	0.000V~15.000V	0.000V~15.000V	0.000V~15.000V
Accuracy	$\pm(0.1 \% \text{ of rdg} + 0.1 \% \text{ of f.s.})$		
<b>Ammeter</b>			
H Range	0.000A~35.000A	0.000A~70.000A	0.00A~210.00A
M Range	0.000A~3.5000A	0.000A~7.0000A	0.00A~21.000A
L Range	0.00mA~350.00mA	0.00mA~700mA	0.0mA~2100.0mA

Accuracy	Stand alone:	$\pm(0.2\% \text{ of rdg} + 0.3\% \text{ of f.s} \text{ }^{*1})$
	Parallel Operation:	$\pm(1.2\% \text{ of rdg} + 1.1\% \text{ of f.s.})$

Wattmeter			
H, M Range	0.00W~175.00W	0.00W~350.00W	0.00W~1050W
L(CC/CR/ CV mode)	0.000W~52.500W	0.000W~ 105.000W	0.00W~315.00W
L(CP mode)	0.0000W~ 1.7500W	0.0000W~ 3.5000W	0.000W~ 10.500W
Temperature Coefficient per °C			
Voltmeter	100ppm		
Ammeter	200ppm		

\*1 M range applies to the full scale of H range.

### 7-8-9. Dynamic Mode

Model	LSG-175	LSG-350	LSG-1050
Operating Mode			
	CC , CR , CP		
T1 & T2			
	0.025ms ~ 10ms / Res: 1us 10ms ~ 30s / Res: 1ms		
Accuracy			
	$\pm 100\text{ppm}$ of setting		
Frequency Range (Freq./Duty)			
	1Hz ~20kHz		
Frequency Resolution			
1Hz~9.9Hz	0.1Hz		
10Hz~99Hz	1Hz		
100Hz~990Hz	10Hz		
1kHz~20kHz	100Hz		
Frequency Accuracy of Setting			
	(0.5% of set)		
Duty Cycle of Setting (Freq./Duty)			
	1% ~99% , 0.1% step		
	The minimum time width is 10 us. Between 1kHz and 20kHz, the maximum duty cycle is limited by the minimum time width.		

Slew Rate Setting Range (CC Mode)			
H Range	2.5mA/us~2.5A/us	5mA/us~5A/us	16mA/us~16A/us
M Range	250uA/us~250mA/us	500uA/us~500mA/us	1.6mA/us~1.6A/us
L Range	25uA/us~25mA/us	50uA/us~50mA/us	160uA/us~160mA/us
Slew Rate Setting Range (CR Mode)			
H Range	250uA/us~250mA/us	500uA/us~500mA/us	1.6mA/us~1.6A/us
M Range	25uA/us~25mA/us	50uA/us~50mA/us	160uA/us~160mA/us
L Range	2.5uA/us~2.5mA/us	5uA/us~5mA/us	16uA/us~16mA/us



Slew Rate Resolution			
Resolution	1mA	2mA	6mA
Setting	250mA/us~2.5A/us	500mA/us~5A/us	1.6A/us~16A/us
Resolution	100uA	200uA	600uA
Setting	25mA/us~250mA/us	50mA/us~500mA/us	160mA/us~1.6A/us
Resolution	10uA	20uA	60uA
Setting	2.5mA/us~25mA/us	5mA/us~50mA/us	16mA/us~160mA/us
Resolution	1uA	2uA	6uA
Setting	250uA/us~2.5mA/us	500uA/us~5mA/us	1.6mA/us~16mA/us
Resolution	100nA	200nA	600nA
Setting	25uA/us~250uA/us	50uA/us~500uA/us	160uA/us~1.6mA/us
Resolution	10nA	20nA	60nA
Setting	2.5uA/us~25uA/us	5uA/us~50uA/us	16uA/us~160uA/us

**Slew Rate Accuracy of setting**  
 $\pm(10\% \text{ of set} + 5\text{us})$

\*1 Time to reach from 10 % to 90 % when the current is varied from 2 % to 100 % (20 % to 100 % in M range) of the rated current.

Current Setting Range			
H Range	0A~36.75A	0A~73.5A	0A~220.5A
M Range	0A~3.675A	0A~7.35A	0A~22.05A
L Range	0A~0.3675A	0A~0.735A	0A~2.205A
Current Resolution			
H Range	1mA	2mA	10mA
M Range	0.1mA	0.2mA	1mA
L Range	0.01mA	0.02mA	0.1mA
Current Accuracy			
$\pm 0.4\% \text{ of f.s.}$			

Resistance Setting Range			
H Range	24.5S~0S (40.8163m $\Omega$ ~OPEN)	49.0S~0S (20.408m $\Omega$ ~OPEN)	147.000S~0S (6.8027m $\Omega$ ~OPEN)
M Range	2.45S~0S (408.1633m $\Omega$ ~OPEN)	4.90S~0S (204.08m $\Omega$ ~OPEN)	14.70000S~0S (68.0272m $\Omega$ ~OPEN)
L Range	0.245S~0S (4.08163 $\Omega$ ~OPEN)	0.490S~0S (2.0408 $\Omega$ ~OPEN)	1.4000S~0S (680.2721m $\Omega$ ~OPEN)

Resistance Resolution			
H Range	400uS	800uS	2.4mS
M Range	40uS	80uS	240uS
L Range	4uS	8uS	24.0uS

Resistance Accuracy of setting (set <sup>*1</sup> > 0.03% of f.s)	
H, M Range	$\pm(0.5\% \text{ of set}^{*1} + 0.5\% \text{ of f.s.}^{*2}) + \text{Vin}^{*3}/500 \text{ k}\Omega$
L Range	$\pm(0.5\% \text{ of set}^{*1} + 0.5\% \text{ of f.s.}) + \text{Vin}^{*3}/500 \text{ k}\Omega$

\*1 set = Vin / Rset

\*2 f.s. = Full scale of High Range

\*3 Vin = Input terminal voltage of Electronic Load

Power Operating Range			
H Range	17.5W~175W	35W~350W	105W~1050W
M Range	1.75W~17.5W	3.5W~35W	10.5W~105W
L Range	0.175W~1.75W	0.35W~3.5W	1.05W~10.5W
Setting Range			
H Range	0W~183.75W	0W~367.5W	0W~1102.5W
M Range	0W~18.375W	0W~36.75W	0W~110.25W
L Range	0W~1.8375W	0W~3.675W	0W~11.025W
Resolution			
H Range	10mW	10mW	100mW
M Range	1mW	1mW	10mW
L Range	0.1mW	0.1mW	1mW
Accuracy of Setting <sup>*1</sup>			
$\pm(0.6 \% \text{ of set} + 1.4 \% \text{ of f.s}^2) + V_{in}^3/500k\Omega$			

\*1 It is not applied for the condition of the parallel operation.

\*2 M range applies to the full scale of H range.

\*3  $V_{in}$  = Input terminal voltage of electronic load.

## 7-8-10. Soft Start

Operation Mode	
CC ,CR and CR	
Selectable Time Range	
1~ 200 ms/Res: 1ms	
Time Accuracy	
$\pm(30\% \text{ of set} + 100\mu\text{s})$	

## 7-8-11. Remote Sensing

Voltage that can be Compensated	
2V for a single line	

## 7-8-12. Protection Function

Model	LSG-175	LSG-350	LSG-1050
Overvoltage protection(OVP)			
Turns off the load at 110% of the rated voltage			
Overcurrent protection(OCP)			
0.03 ~ 38.5A		0.06A ~ 77A	
0.2A ~ 231A			
or 110% of the maximum current of each range			
Load off or limit selectable			
Overpower protection(OPP)			
0.1W ~ 192.5W		0.3W ~ 385W	
1W ~ 1155W			
or 110% of the maximum power of each range			
Load off or limit selectable			
Overheat protection(OTP)			
Turns off the load when the heat sink temperature reaches 95 °C			

---

**Undervoltage protection(UVP)**

---

Turns off the load when detected. Can be set in the range of 0 V to 150 V or Off.

---

**Reverse connection protection(RVP)**

---

By diode. Turns off the load when an alarm occurs.

---

**Rating overcurrent protection (R.OCP)**

---

An R.OCP message will be produced when the input current range is greater than 110% of the rated operating current range (I range).

---

**Rating overpower protection (R.OPP)**

---

An R.OPP message will be produced when the input power range is greater than 110% of the rated operating power range.

---

**Front panel input rating overcurrent protection (F.R.OCP)**

---

An F.R.OCP message will be produced when the front panel input current range is greater than 77A (Typical).

---

## 7-9. LSG-H Series Specifications

The specifications apply when the LSG-H Series is powered on for at least 30 minutes to warm-up to a temperature of 20°C to 30°C, unless specified otherwise.

All specifications apply when using the rear panel terminals. If the front panel terminals are used or if operating with long cables, remote sense must be connected to the terminals.

In parallel mode: All operation/settings/resolution specifications are N times. Slew rate maximum value, voltage setting and measured value are not changed.

The maximum slew rate settings also don't change.

N = Number of units in parallel (Same model on master)

N = LSG-1050H + 2 x Number of units in parallel (LSG-2100SH)

### 7-9-1. Rating (Master)

Model	LSG-175H	LSG-350H	LSG-1050H
Operating Voltage	5V~800V		
Current	8.75A	17.5A	52.5A
Power	175W	350W	1050W

### 7-9-2. Rating (Booster)

Model	LSG-2100SH
Operating Voltage	5V~800V
Current	105A
Power	2100W
Current Setting Accuracy	± (1.2% of set + 1.1% of f.s.)
NOTE:M range applies to the full scale of H range	

### 7-9-3. CC Mode

Model	LSG-175H	LSG-350H	LSG-1050H
<b>Operating Range</b>			
H Range	0A~8.75A	0A~17.5A	0A~52.5A
M Range	0A~0.875A	0A~1.75A	0A~5.25A
L Range	0mA~87.5mA	0mA~175mA	0A~0.525A
<b>Setting Range</b>			
H Range	0A~9.1875A	0A~18.3750A	0A~55.126A
M Range	0A~0.91875A	0A~1.83750A	0A~5.5126A
L Range	0mA~91.875mA	0mA~183.750mA	0A~0.55126A
<b>Default Setting</b>			
H Range	0A	0A	0A
M Range	0A	0A	0A
L Range	0mA	0mA	0A
<b>Resolution</b>			
H Range	0.3mA	0.6mA	2mA
M Range	0.03mA	0.06mA	0.2mA
L Range	0.003mA	0.006mA	0.02mA
<b>Accuracy of Setting</b>			
H, M Range	$\pm (0.2 \% \text{ of set} + 0.1 \% \text{ of f.s.}^{*1}) + V_{in}^{*2}/3.24 \text{ M}\Omega$		
L Range	$\pm (0.2 \% \text{ of set} + 0.1 \% \text{ of f.s.}) + V_{in}^{*2}/3.24 \text{ M}\Omega$		
Parallel Operation	$\pm (1.2\% \text{ of set} + 1.1\% \text{ of f.s.}^{*3})$		
<b>Input Voltage Variation<sup>*4</sup></b>			
H Range	20mA+ $V_{in}^{*2}/3.24\text{M}\Omega$		
M Range	20mA+ $V_{in}^{*2}/3.24\text{M}\Omega$		
L Range	2mA+ $V_{in}^{*2}/3.24\text{M}\Omega$		
<b>Ripple</b>			
RMS <sup>*5</sup>	2mA	4mA	12mA
P-P <sup>*6</sup>	20mA	40mA	120mA

\*1 Full scale of H range  
 \*2  $V_{in}$ : input terminal voltage of electronic load  
 \*3 M range applies to the full scale of H range  
 \*4 When the input voltage is varied from 5V to 800V at a current of rated power/800V  
 \*5 Measurement frequency bandwidth: 10Hz to 1MHz  
 \*6 Measurement frequency bandwidth: 10Hz to 20MHz

## 7-9-4. CR Mode

Model	LSG-175H	LSG-350H	LSG-1050H
<b>Operating Range<sup>*1</sup></b>			
H Range	1.75S~30uS (571mΩ~33.3kΩ)	3.5S~60uS (285mΩ~16.6kΩ)	10.5S~180uS (95.2mΩ~5.55kΩ)
M Range	175mS~3uS (5.71Ω~333kΩ)	350mS~6uS (2.85Ω~166kΩ)	1.05S~18uS (952mΩ~55.5kΩ)
L Range	17.5mS~0.3uS (57.1Ω~3.33MΩ)	35mS~0.6uS (28.5Ω~1.66MΩ)	105mS~1.8uS (9.52Ω~555kΩ)
<b>Setting Range</b>			
H Range	1837.50mS~0mS (0.54422Ω~ 33333.3Ω, OPEN)	3675.00mS~0mS (0.27211Ω~ 16666.7Ω, OPEN)	11025.0mS~0mS (0.09070Ω~ 5555.56Ω, OPEN)
M Range	183.750mS~0mS (5.44218Ω~ 333333Ω, OPEN)	367.500mS~0mS (2.72109Ω~ 166666Ω, OPEN)	1102.50mS~0mS (0.90703Ω~ 55555.6Ω, OPEN)
L Range	18.3750mS~0mS (54.4218Ω~ 3333333Ω, OPEN)	36.7500mS~0mS (27.2109Ω~ 1666666Ω, OPEN)	110.250mS~0mS (9.07029Ω~ 555555Ω, OPEN)
<b>Resolution</b>			
H Range	30uS	60uS	180uS
M Range	3uS	6uS	18uS
L Range	0.3uS	0.6uS	1.8uS
<b>Accuracy of Setting<sup>*2</sup></b>			
H, M Range	$\pm (0.5 \% \text{ of set}^{*3} + 0.5 \% \text{ of f.s.}^{*4}) + V_{in}^{*5}/3.24M\Omega$		
L Range	$\pm (0.5 \% \text{ of set}^{*3} + 0.5 \% \text{ of f.s.}) + V_{in}^{*5}/3.24M\Omega$		
Parallel Operation	$\pm (1.2\% \text{ of set} + 1.1\% \text{ of f.s.}^{*4})$		
*1 Siemens[S] = Input current[A] / Input voltage[V] = 1 / resistance[Ω]			
*2 Converted value at the input current. At the input current. At the sensing point during remote sensing under the operating range of the input voltage.			
*3 set = $V_{in} / R_{set}$			
*4 f.s. = Full scale of High Range			
*5 $V_{in}$ = Input terminal voltage of electronic load			

### 7-9-5. CV Mode

Model	LSG-175H	LSG-350H	LSG-1050H
<b>Operating Range</b>			
H Range	5V~800V		
L Range	5V~80V		
<b>Setting Range</b>			
H Range	0V~840.00V		
L Range	0V~84.000V		
<b>Resolution</b>			
H Range	20mV		
L Range	2mV		
<b>Accuracy of Setting<sup>*1</sup></b>			
H, L Range	± (0.2 % of set + 0.2 % of f.s.)		
<b>Input current variation<sup>*2</sup></b>			
H, L Range	80mV		

\*1 At the sensing point during remote sensing under the operating range of the input voltage. It is also applied for the condition of the parallel operation.  
 \*2 With respect to a change in the current of 10 % to 100 % of the rating at an input voltage of 5 V (during remote sensing).

### 7-9-6. CP Mode

Model	LSG-175H	LSG-350H	LSG-1050H
<b>Operating Range</b>			
H Range	17.5W~175W	35W~350W	105W~1050W
M Range	1.75W~17.5W	3.5W~35W	10.5W~105W
L Range	0.175W~1.75W	0.35W~3.5W	1.05W~10.5W
<b>Setting Range</b>			
H Range	0W~183.75W	0W~367.50W	0W~1102.5W
M Range	0W~18.375W	0W~36.750W	0W~110.25W
L Range	0W~1.8375W	0W~3.6750W	0W~11.025W
<b>Resolution</b>			
Hレンジ	10mW	10mW	100mW
Mレンジ	1mW	1mW	10mW
Lレンジ	0.1mW	0.1mW	1mW
<b>Accuracy of Setting<sup>*1</sup></b>			
±(0.6 % of set + 1.4 % of f.s. <sup>*2</sup> ) + Vin <sup>2</sup> *3/ 3.24MΩ			

\*1 At the sensing point during remote sensing under the operating range of the input voltage.  
 It is not applied for the condition of the parallel operation.  
 \*2 M range applies to the full scale of H range.  
 \*3 Vin = Input terminal voltage of electric load.

### 7-9-7. Slew Rate

Model	LSG-175H	LSG-350H	LSG-1050H
<b>Setting Range (CC Mode)</b>			
H Range	0.1400mA/us~ 140.0mA/us	0.280mA/us~ 280.0mA/us	0.840mA/us~ 840.0mA/us
M Range	0.01400mA/us~ 14.000mA/us	0.0280mA/us~ 28.00mA/us	0.0840mA/us~ 84.00mA/us
L Range	1.400uA/us~ 1400.0uA/us	2.80uA/us~ 2800uA/us	0.00840mA/us~ 8.400mA/us
<b>Setting Range (CR Mode)</b>			
H Range	0.01400mA/us~ 14.000mA/us	0.0280mA/us~ 28.00mA/us	0.0840mA/us~ 84.00mA/us
M Range	0.001400mA/us~ 1.4000mA/us	0.00280mA/us~ 2.800mA/us	0.00840mA/us~ 8.400mA/us
L Range	0.1400uA/us~ 140.00uA/us	0.280uA/us~ 280.0uA/us	0.000840mA/us~ 0.8400mA/us
<b>Resolution</b>			
Resolution	50uA/us	100uA/us	300uA/us
Setting	14mA/us~ 140mA/us	28mA/us~ 280mA/us	84mA/us~ 840mA/us
Resolution	5uA/us	10uA/us	30uA/us
Setting	1.4mA/us~14mA/us	2.8mA/us~28mA/us	8.4mA/us~84mA/us
Resolution	0.5uA/us	1uA/us	3uA/us
Setting	140uA/us~ 1.4mA/us	280uA/us~ 2.8mA/us	840uA/us~ 8.4mA/us
Resolution	50nA/us	0.1uA/us	0.3uA/us
Setting	14uA/us~140uA/us	28uA/us~280uA/us	84uA/us~840uA/us
Resolution	5nA/us	10nA/us	30nA/us
Setting	1.4uA/us~14uA/us	2.8uA/us~28uA/us	8.4uA/us~84uA/us
Resolution	0.5nA/us	1nA/us	3nA/us
Setting	0.14uA/us~ 1.4uA/us	0.28uA/us~ 2.8uA/us	0.84uA/us~ 8.4uA/us
<b>Accuracy of Setting*<sup>1</sup></b>			
±(10% of set + 25us)			
*1 Time to reach from 10% to 90% when the current is varied from 2% to 100% (20% to 100% in M range) of the rated current.			



### 7-9-8. Meter

Model	LSG-175H	LSG-350H	LSG-1050H
<b>Voltmeter</b>			
H Range	0.00V~800.00V		
L Range	0.000V~80.000V		
Accuracy	± (0.1 % of rdg + 0.1 % of f.s.)		
<b>Ammeter</b>			
H Range	0.0000A~8.7500A	0.000A~17.500A	0.000A~52.500A
M Range	0.00000A~0.87500A	0.0000A~1.7500A	0.0000A~5.2500A
L Range	0.000mA~87.500mA	0.000mA~175.00mA	0.00mA~525.00mA
Accuracy	Stand alone: ±(0.2 % of rdg + 0.3 % of f.s. <sup>1</sup> ) Parallel Operation: ± (1.2% of rdg + 1.1% of f.s.)		
<b>Wattmeter</b>			
H, M Range	0.00W~175.00W	0.00W~350.00W	0.0W~1050.0W
L(CC/CR/ CV mode)	0.0000W~56.875W	0.0000W~113.75W	0.000W~341.25W
L(CP mode)	0.0000W~1.7500W	0.0000~3.5000W	0.000W~10.500W
<b>Temperature Coefficient (per °C)</b>			
Voltmeter	100ppm		
Ammeter	200ppm		
*1 M Range applies to the full scale of H Range.			

### 7-9-9. Dynamic Mode

Model	LSG-175H	LSG-350H	LSG-1050H
<b>Operating Mode</b>			
	CC ,CR , CP		
<b>T1 &amp; T2</b>			
	0.025ms ~ 10ms / Res: 1us 10ms ~ 30s / Res: 1ms		
<b>Accuracy</b>			
	± 100ppm of setting		
<b>Frequency Range (Freq./Duty)</b>			
	1Hz ~20kHz		
<b>Frequency Resolution</b>			
1Hz~9.9Hz	0.1Hz		
10Hz~99Hz	1Hz		
100Hz~990Hz	10Hz		
1kHz~20kHz	100Hz		
<b>Frequency Accuracy of Setting</b>			
	(0.5% of set)		
<b>Duty Cycle of Setting (Freq./Duty)</b>			
	1% ~99% , 0.1% step The minimum time width is 10 us. Between 1kHz and 20kHz, the maximum duty cycle is limited by the minimum time width.		

Slew Rate Setting Range (CC Mode)			
H Range	0.1400mA/us~ 140.0mA/us	0.280mA/us~ 280.0mA/us	0.840mA/us~ 840.0mA/us
M Range	0.01400mA/us~ 14.000mA/us	0.0280mA/us~ 28.00mA/us	0.0840mA/us~ 84.00mA/us
L Range	1.400uA/us~ 1400.0uA/us	2.80uA/us~ 2800uA/us	0.00840mA/us~ 8.400mA/us
Slew Rate Setting Range (CR Mode)			
H Range	0.01400mA/us~ 14.000mA/us	0.0280mA/us~ 28.00mA/us	0.0840mA/us~ 84.00mA/us
M Range	0.001400mA/us~ 1.4000mA/us	0.00280mA/us~ 2.800mA/us	0.00840mA/us~ 8.400mA/us
L Range	0.1400uA/us~ 140.00uA/us	0.280uA/us~ 280.0uA/us	0.000840mA/us~ 0.8400mA/us
Model	LSG-175H	LSG-350H	LSG-1050H
Slew Rate Resolution			
Resolution	50uA/us	100uA/us	300uA/us
Setting	14mA/us~ 140mA/us	28mA/us~ 280mA/us	84mA/us~ 840mA/us
Resolution	5uA/us	10uA/us	30uA/us
Setting	1.4mA/us~ 14mA/us	2.8mA/us~ 28mA/us	8.4mA/us~ 84mA/us
Resolution	0.5uA/us	1uA/us	3uA/us
Setting	140uA/us~ 1.4mA/us	280uA/us~ 2.8mA/us	840uA/us~ 8.4mA/us
Resolution	50nA/us	0.1uA/us	0.3uA/us
Setting	14uA/us~140uA/us	28uA/us~280uA/us	84uA/us~840uA/us
Resolution	5nA/us	10nA/us	30nA/us
Setting	1.4uA/us~14uA/us	2.8uA/us~28uA/us	8.4uA/us~84uA/us
Resolution	0.5nA/us	1nA/us	3nA/us
Setting	0.14uA/us~ 1.4uA/us	0.28uA/us~ 2.8uA/us	0.84uA/us~ 8.4uA/us
Slew Rate Accuracy of setting *1			
±(10% of set + 25us)			
*1 Time to reach from 10 % to 90 % when the current is varied from 2 % to 100 % (20 % to 100 % in M range) of the rated current.			
Current Setting Range			
H Range	0A~9.1875A	0A~18.375A	0A~55.125A
M Range	0A~0.91875A	0A~1.8375A	0A~5.5125A
L Range	0mA~91.875mA	0mA~183.75mA	0A~0.55125A
Current Resolution			
H Range	0.3mA	0.6mA	2mA
M Range	0.03mA	0.06mA	0.2mA
L Range	0.0003mA	0.006mA	0.02mA
Current Accuracy			
±0.4% of f.s.			

Model	LSG-175H	LSG-350H	LSG-1050H
<b>Resistance Setting Range</b>			
H Range	1837.50mS~0mS (0.54422Ω~ 33333.3Ω,OPEN)	3675.00mS~0mS (0.27211Ω~ 16666.7Ω,OPEN)	11025.0mS~0mS (0.09070Ω~ 5555.56Ω,OPEN)
M Range	183.750mS~0mS (5.44218Ω~ 333333Ω,OPEN)	367.500mS~0mS (2.72109Ω~ 166666Ω,OPEN)	1102.50mS~0mS (0.90703Ω~ 55555.6Ω,OPEN)
L Range	18.3750mS~0mS (54.4218Ω~ 3333333Ω,OPEN)	36.7500mS~0mS (27.2109Ω~ 1666666Ω,OPEN)	110.250mS~0mS (9.07029Ω~ 555555Ω,OPEN)
<b>Resistance Resolution</b>			
H Range	30uS	60uS	180uS
M Range	3uS	6uS	18uS
L Range	0.3uS	0.6uS	1.8uS
<b>Resistance Accuracy of setting (set<sup>*1</sup> &gt; 0.03% of f.s.)</b>			
H, M Range	$\pm(0.5 \% \text{ of set}^{*1} + 0.5 \% \text{ of f.s.}^{*2}) + \text{Vin}^{*3}/3.24\text{M}\Omega$		
L Range	$\pm(0.5 \% \text{ of set}^{*1} + 0.5 \% \text{ of f.s.}) + \text{Vin}^{*3}/3.24\text{M}\Omega$		
*1 set = Vin / Rset			
*2 f.s. = Full scale of High Range			
*3 Vin = Input terminal voltage of Electronic Load			
<b>Power Operating Range</b>			
H Range	17.5W~175W	35W~350W	105W~1050W
M Range	1.75W~17.5W	3.5W~35W	10.5W~105W
L Range	0.175W~1.75W	0.35W~3.5W	1.05W~10.5W
<b>Setting Range</b>			
H Range	0W~183.75W	0W~367.50W	0W~1102.5W
M Range	0W~18.375W	0W~36.750W	0W~110.25W
L Range	0W~1.8375W	0W~3.6750W	0W~11.025W
<b>Resolution</b>			
H Range	10mW	10mW	100mW
M Range	1mW	1mW	10mW
L Range	0.1mW	0.1mW	1mW
<b>Accuracy of Setting<sup>*1</sup></b>			
$\pm(0.6 \% \text{ of set} + 1.4 \% \text{ of f.s.}^{*2}) + \text{Vin}^{*3}/3.24\text{M}\Omega$			
*1 It is not applied for the condition of the parallel operation.			
*2 M range applies to the full scale of H range.			
*3 Vin = Input terminal voltage of electronic load.			

### 7-9-10. Soft Start

Operation Mode	CC,CR
Selectable Time Range	OFF, 1~ 200ms / Res: 1ms
Time Accuracy	±(30%of set + 100us)

### 7-9-11. Remote Sensing

Voltage that can be Compensated	2V for a single line
---------------------------------	----------------------

### 7-9-12. Protection Function

Model	LSG-175H	LSG-350H	LSG-1050H
Overvoltage protection(OVP)	Turns off the load at 110% of the rated voltage		
Overcurrent protection(OCP)	0.0060A ~ 9.6252A	0.0120A ~ 19.2504A	0.050A ~ 57.750A
	or 110% of the maximum current of each range Load off or limit selectable		
Overpower protection(OPP)	0.10W ~ 192.50W	0.10W ~ 385.00W	1.00W ~ 1155.00W
	or 110% of the maximum power of each range Load off or limit selectable		
Overheat protection(OTP)	Turns off the load when the heat sink temperature reaches 105°C (LSG-2100SH: 115°C).		
Under voltage protection(UVP)	Turns off the load when detected. Can be set in the range of OFF, 0.1V to 840V or Off.		
Reverse connection protection(RVP)	By diode. Turns off the load when an alarm occurs.		
Rating overcurrent protection (R.OCP)	An R.OCP message will be produced when the input current range is greater than 110% of the rated operating current range (I range).		
Rating overpower protection (R.OPP)	An R.OPP message will be produced when the input power range is greater than 110% of the rated operating power range.		

## 7-10. LSG/LSG-H Specifications

### 7-10-1. Sequence

Normal Sequence	
Operation mode	CC, CR, CV, CP
Maximum number of steps	1000
Step Execution Time	0.05ms ~ 999h 59min
Time resolution	0.05 ms (0.05ms ~1 min) 100 ms (1 min ~1 h) 1 s (1 h ~10 h)/10 s (10 h ~100 h) 1 min (100 h ~999 h 59 min)
Fast Sequence	
Operation mode	CC or CR
Maximum number of steps	1000
Step Execution Time	25us – 600ms
Time resolution	1us(25us - 60ms) 10us(60.01ms - 600ms)

### 7-10-2. Other

Elapsed Time Delay	
	Measures the time from load on to load off. On/Off selectable. Measures from 1s up to 999h 59min 59s
Auto Load Off Timer	
	Automatically turns off the load after a specified time elapses. Can be set in the range of 1s to 999h 59min 59s or off
Communication Function	
Command set	Sets panel functions except the power switch and reads measured values. Supports the SCPI and IEEE std. 488.2-1992 command set Delimiter:LF(0x0A)
GP-IB (Optional)	IEEE std. 488.1-1978 (partial support) SH1, AH1, T6, L4, SR1, DC1, DT1.
RS-232C	D-SUB 9-pin connector (conforms to EIA-232-D) Baud rate: 2400, 4800, 9600, 19200, 38400 bps Data length: 8-bit, Stop bit: 1, 2-bit, Parity bit: None, Odd, Even.
USB	Conforms to USB 2.0 Specifications and USB-CDC ACM Communication speed 12Mbps (Full speed)
LAN (Optional)	100BASE-TX, AUTO-MDIX, RJ-45, IPv4, DHCP ON/OFF, Socket Port:2268, HTTP Port:80

### 7-10-3. Analog External Control

Load on/off Control Input
Turn on the load with low (or high) TTL level signal.
Load on Status Output
On when the load is on. (open collector output by a photo coupler)
Range Switch Input
Switch ranges L, M, and H using a 2-bit signal.
Range Status Output
Outputs range L, M, or H using 2-bit signal. (open collector output by a photo coupler)
Trigger Input
Clear the sequence operation pause with a high TTL level signal for 10us or more.
Alarm Input
Activate alarm with low TTL level signal input.
Alarm Status Output
On when OVP, OCP, OPP, OTP, UVP, RVP, or when an external alarm input is applied. (open collector output by a photo coupler)
Short Signal Output
Relay contact output. (30VDC/1A)
External Voltage Control
Operates in CC, CR, CV, CP or Cx+CV mode. 0 V to 10 V correspond to 0 % to 100 % of the rated current (CC mode), rated voltage (CV, Cx+CV mode), or rated power (CP mode). 0 V to 10 V correspond to maximum resistance to minimum resistance. (CR mode)
External Resistance Control
Operates in CC, CR, CV or CP mode. 0 $\Omega$ to 10k $\Omega$ correspond to 0% to 100% or 100% to 0% of the rated current (CC mode), rated voltage (CV mode), or rated power (CP mode). 0 $\Omega$ to 10k $\Omega$ correspond to maximum resistance to minimum resistance or minimum resistance to maximum resistance. (CR mode)
Current Monitor Output
10V f.s. (H or L range) and 1V f.s. (M range)
Voltage Monitor Output
10V f.s.
Parallel Operation Input
Signal input for one-control parallel operation.
Parallel Operation Output
Signal input for one-control parallel operation.
Load Boost Power Supply Control
Power on/off control signal for the load booster.

## 7-10-4. Front Panel BNC Connector

<b>TRIG OUT</b>
Trigger output: Approx. 4.5V pulse width: Approx. 2 $\mu$ s, output impedance: Approx. 500 $\Omega$ . Outputs a pulse during sequence operation and switching operation.
<b>I MON OUT</b>
Current monitor output. 10V f.s. (H or L range) and 1V f.s. (M range)
<b>V MON OUT (LSG-175H / 350H / 1050H)</b>
Voltages monitor output. 8V f.s.

## 7-10-5. General

Model	LSG-175 LSG-175H	LSG-350 LSG-350H	LSG-1050 LSG-1050H	LSG-2100S LSG-2100SH
<b>Input Range</b>	90VAC~132VAC/180VAC~250VAC $\pm$ 10% Single-phase			
<b>Input Frequency</b>	47~63Hz			
<b>Power (max)</b>	90VA	110VA	190VA	230VA
<b>Inrush Current</b>	45A Max			
<b>Insulation Resistance</b>	Primary to input terminal: 1000VDC, 20M $\Omega$ or more. Primary to chassis: 1000VDC, 20M $\Omega$ or more.			
<b>Withstand Voltage</b>	Primary to input terminal: No abnormalities at 1500VAC for 1 minute. Primary to chassis: No abnormalities at 1500VAC for 1 minute.			
<b>Dimensions</b>				
W	213.8 mm	213.8 mm	427.8 mm	427.7 mm
H	124.0 mm	124.0 mm	124.0 mm	127.8 mm
D	400.5 mm	400.5 mm	400.5 mm	553.5 mm
<b>Weight</b>				
Approx.	7.5kg	9kg	17kg	24kg
Maximum	9kg	10kg	20kg	28kg
<b>Operation Environment</b>				
Temperature	0 $^{\circ}$ C~40 $^{\circ}$ C			
Relative Humidity	$\leq$ 70%RH(no condensation)			
<b>Storage Environment</b>				
Temperature	-10 $^{\circ}$ C~70 $^{\circ}$ C			
Relative Humidity	$\leq$ 80%RH(no condensation)			

## 一般仕様

Environment	Indoor, Altitude < 2000m, Overvoltage category II
LVD	EN61010-1(Class1, Pollution 2), 2014/35/EU Conformity
EMC	EN61326-1 (Class A), 2014/30/EU Conformity
Battery	Litium metal type CR123A x 1



## 7-11. Dimensions

### 7-11-1. LSG-175/ LSG-175H/ LSG-350/ LSG-350H

エラー! 編集中のフィールド コードからは、オブジェクトを作成できません。

7-11-2. LSG-1050 / LSG-1050H

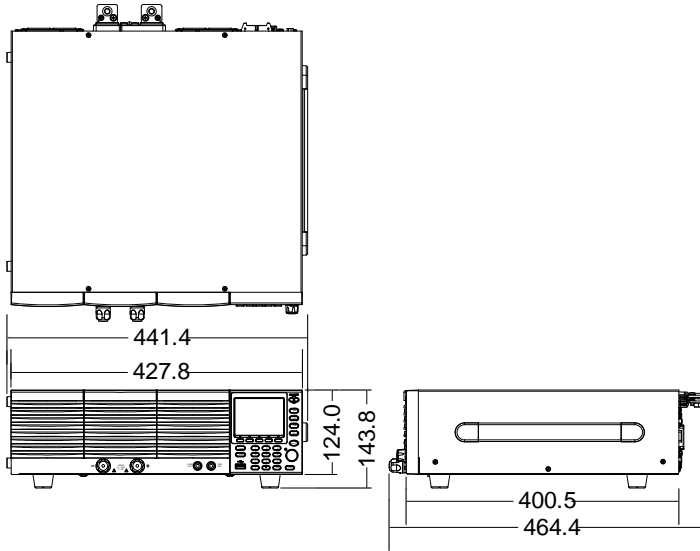

7-11-3. LSG-2100S/SH

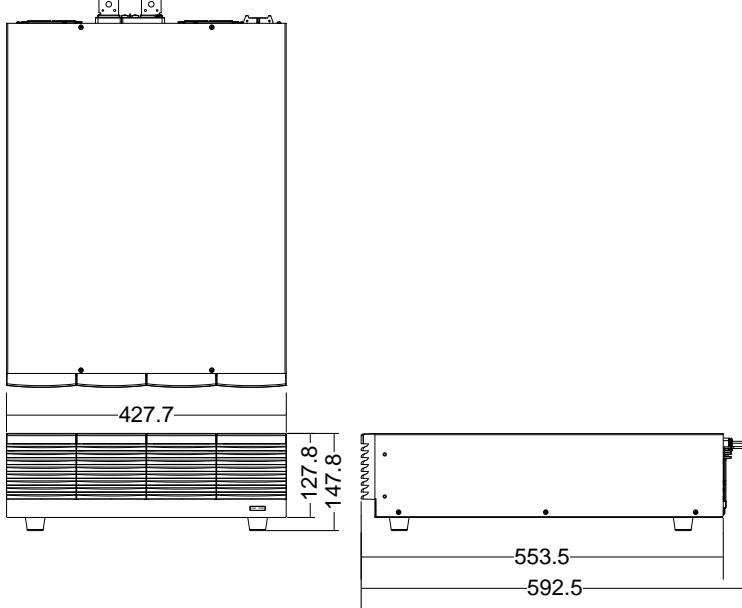



**TEXIO TECHNOLOGY CORPORATION**

7F Towa Fudosan Shin Yokohama Bldg.

2-18-13, Shin Yokohama, Kohoku-ku, Yokohama, Kanagawa, 222-0033 Japan

<https://www.texio.co.jp/>

---