

INSTRUCTION MANUAL

HIGH POWER ELECTRONIC LOAD LSC SERIES

LSC402-151
LSC502-151
LSC602-151

LSC402-601
LSC502-601
LSC602-601

LSC402-122
LSC502-122
LSC602-122



CONTENTS

USING THE PRODUCT SAFELY	I -IV
1. GETTING STARTED.....	1
1-1. LSC Series Introduction	1
1-1-1. Main features.....	1
1-1-2. Protection function.....	2
1-2. Accessories	3
1-3. Description of operating mode	6
1-3-1. CC mode	6
1-3-2. CR mode	6
1-3-3. CV mode.....	7
1-3-4. CP mode.....	7
1-3-5. Slew rate.....	8
1-3-6. Dynamic mode.....	9
1-4. Operating range	12
1-4-1. LSC402-151, LSC502-151, LSC602-151	12
1-4-2. LSC402-601, LSC502-601, LSC602-601	13
1-4-3. LSC402-122, LSC502-122, LSC602-122	14
2. Front panel	15
2-1. Power switch	16
2-2. LCD display	16
2-3. Function keys	18
2-3-1. MODE key	18
2-3-2. Load On/Off key.....	18
2-3-3. Preset key.....	19
2-3-4. DYN/STA key.....	20
2-3-5. DYN Setting key	20
2-3-6. Range key.....	21
2-3-7. Level key	22
2-3-8. Limit key	22
2-3-9. CONF key.....	24
2-3-10. System key	26
2-3-11. Local key.....	28
2-4. Auto sequence keys	28
2-5. Memory keys	28
2-5-1. Recall key.....	28
2-5-2. Store key	29
2-6. Test Setting keys.....	29
2-7. Number keys.....	29
2-8. Rotary knob and arrow keys	30
3. Rear panel	31
3-1. DC input terminal	31
3-2. V sense terminal	32

3-3. Current monitor terminal	33
3-4. Analog voltage input terminal	34
3-5. Master-slave control connector	35
3-6. Communication interface slot	35
3-7. Fuse	35
3-8. AC power input terminal	35
4. Setup	36
4-1. Power supply voltage check and AC fuse	36
4-2. Necessity of grounding	36
4-3. Power on	36
4-4. Connection to DC input terminal	37
4-5. Connection to V sense terminal	38
4-6. Connection to analog I / O terminal	39
4-6-1. Current monitor terminal	39
4-6-2. Analog voltage input terminal	39
4-7. Communication interface	40
4-8. Effect of load line inductance component	41
4-9. Rack mount kit installation	42
5. Description of master-slave parallel operation	43
5-1. Master machine and slave machine settings	43
5-2. Control connector connection method	43
5-3. Load line connection	43
5-4. Remote sense line connection	44
5-5. Power Switch ON / OFF	44
5-6. Display of master machine and slave machine	45
5-7. Available remote commands	45
6. Basic operation method	46
6-1. Static mode	46
6-1-1. CC, CR, CP, CV mode	46
6-1-2. CV+C/P limit mode	46
6-2. Dynamic mode	47
7. Test functions description and operation	49
7-1. Short test	49
7-2. OCP test	50
7-3. OPP test	52
7-4. BMS test	54
7-4-1. BMS Short test	54
7-4-2. BMS OCP test	56
7-5. Batt test	57
7-6. Surge test	59
7-7. SEQUENCE LOAD	60
8. Description of AUTO Sequence function	62
8-1. Editing the AUTO sequence function	62

8-2. Executing Automatic test	64
8-3. AUTO Sequence setting example	65
8-3-1. Settings of various setting states	65
8-3-2. Set up Automatic test.....	66
9. Remote control.....	67
9-1. Interface configuration	67
9-1-1. RS-232C configuration	67
9-1-2. GP-IB configuration	68
9-1-3. USB configuration.....	69
9-1-4. LAN configuration	70
9-2. Command syntax	73
9-2-1. The description of abbreviation.....	73
9-2-2. Communication Interface programming command syntax description.	73
9-3. Remote commands	74
9-3-1. Preset commands.....	74
9-3-2. Limit command	87
9-3-3. Status command.....	90
9-3-4. System command.....	95
9-3-5. Measure command	96
9-3-6. AUTO Sequence command.....	97
10. application	100
10-1. V sense terminal	100
10-2. CC mode	100
10-3. CV mode.....	101
10-4. CR mode	101
10-5. CP mode.....	103
10-6. CV+C limit mode	104
10-7. CV+P limit mode	105
10-8. Constant current source operation	105
10-9. Zero-volt load.....	107
10-10. Parallel operation	107
10-11. OCP test setting example	108
10-12. OPP test setting example	109
10-13. Short test setting example	111
10-14. Battery discharge test	112
10-14-1. Measuring battery capacity with Batt test	112
10-15. SEQUENCE LOAD test example	114
11. LSC specifications	115
11-1. Default Settings.....	115
11-2. LSC series Specifications	118
11-2-1. LSC402-151.....	118
11-2-2. LSC502-151.....	121
11-2-3. LSC602-151.....	124
11-2-4. LSC402-601.....	127
11-2-5. LSC502-601.....	130

11-2-6. LSC602-601.....	133
11-2-7. LSC402-122.....	136
11-2-8. LSC502-122.....	139
11-2-9. LSC602-122.....	142
11-2-10. Common	145
11-3. LSC series dimensions	146

■ About the manual.

In order to be environmentally friendly and reduce waste, we are gradually discontinuing the use of paper or CD manuals that come with our products. Even if there is a description attached to the instruction manual, it may not be attached. The latest version of the instruction manual is posted on our website (<https://www.texio.co.jp/download/>).

■ About firmware version

The contents described in this document apply to LSC series main unit firmware version 2.03 or higher.

USING THE PRODUCT SAFELY

■ Preface

To use the product safely, read this instruction manual to the end. Before using this product, understand how to correctly use it.



If you read this manual but you do not understand how to use it, ask us or your local dealer. After you read this manual, save it so that you can read it anytime as required.

■ Notes on reading this instruction manual

- ◆ The contents of this instruction manual include technical terms in part of their explanation. If you do not understand those terms, do not hesitate to ask us or your local dealer.

■ Pictorial indication and warning character indication

This instruction manual and product show the warning and caution items required to safely use the product. The following pictorial indication and warning character indication are provided.

<p><Pictorial indication></p> 	<p>Some part of this product or the instruction manual may show This pictorial indication. In this case, if the product is incorrectly used in that part, a serious danger may be brought about on the user's body or the product. To use the part with this pictorial indication, be sure to refer to this instruction manual.</p>
<p><Warning character Indication></p>  <p>WARNING</p>  <p>CAUTION</p>	<p>If you use the product, ignoring this indication, you may get killed or seriously injured. This indication shows that the warning item to avoid the danger is provided.</p> <p>If you incorrectly use the product, ignoring this indication, you may get slightly injured or the product may be damaged. This indication shows that the caution item to avoid the danger is provided.</p>

USING THE PRODUCT SAFELY



WARNING

■ Do not remove the product's covers and panels

Never remove the product's covers and panels for any purpose. Otherwise, the user's electric shock or a fire may be incurred.

■ Warning on using the product

The warning items given below are to avoid danger to the user's body and life and avoid the damage and deterioration of the product.

Use the product, observing the following warning and caution items.

■ Warning items on power supply

- Power supply voltage

As the rated power supply voltage of the product, the range from 100 to 240 VAC can be used without being switched.

- Power cord

Important: The attached power cord set can be used for this device only.

- Protection fuse

If an input protection fuse is blown, the product does not operate. When the fuse is blown, the user can replace it. However, replace it correctly, observing the warning and caution items that are provided in the section of the instruction manual where the fuse replacement is explained. If the fuse is incorrectly replaced, a fire may occur.

- Changing the power supply voltage

The rated power supply voltage cannot be changed. Use the product only at the rated power supply voltage indicated on the product. Otherwise, a fire may occur. The product's rated power supply voltage is from 100 to 240 VAC. Use the product in this range. (For use at a voltage higher than 125 VAC, Please confirm the voltage ratings of the power cord.)

■ Warning item on grounding

The product has the GND terminal on the panel surface to protect the user from electric shock and protect the product. Be sure to ground the product to safely use it.

USING THE PRODUCT SAFELY



WARNING

■ Warning item on installation environment

- Operating temperature
Use the product within the operating temperature indicated in the rating column. If the product is used with the vents of the product blocked or in high ambient temperatures, a fire may occur.
- Operating humidity
Use the product within the operating humidity indicated in the rating column. Watch out for condensation by a sharp humidity change such as transfer to a room with a different humidity. Also, do not operate the product with wet hands. Otherwise, an electric shock or fire may occur.
- Use in a gas
Use in and around a place where an inflammable or explosive gas or steam is generated or stored may result in an explosion and fire. Do not operate the product in such an environment.
Also, use in and around a place where a corrosive gas is generated or spreading causes a serious damage to the product. Do not use the product in such an environment.
- Do not let foreign matter in
Do not insert metal and flammable materials into the product from its vent and spill water on it. Otherwise, an electric shock and fire may occur.

■ Warning item on abnormality while in use

If smoke or fire is generated from the product while in use, stop using the product, turn off the switch, and remove the power cord plug from the outlet. After confirming that no other devices catch fire, call the company or each sales office.

■ Front Panel

Please do not lift up the product, while touching the front grille.

USING THE PRODUCT SAFELY



CAUTION

■ Input/output terminal

Maximum input to the input terminals is specified to prevent the product from being damaged. Do not supply input, exceeding the specifications that are indicated in the "Rating" or "Caution on use" column in the instruction manual of the product. Otherwise, a product failure is caused. Also, do not supply power to the output terminals from the outside. Otherwise, a product failure is caused.

■ When the product is left unused for a long time

Be sure to remove the power plug from the outlet.

(Calibration)

Although the performance and specifications of the product are checked under strict quality control during shipment from the factory, they may aging rate because of aging rate in its parts. It is recommended to periodically calibrate the product so that it is used with its performance and specifications stable. For consultation about the product calibration, call the dealer or the company or each sales office where you bought the product.

(Daily maintenance)

When you clean off the dirt of the product covers, panels, and knobs, avoid solvents such as thinner and benzene. Otherwise, paint may peel off or the resin surface may be affected.

To wipe off the covers, panels, and knobs, use a soft cloth with neutral detergent in it. During cleaning, be careful that water, detergents, and other foreign matters do not get into the product.

If a liquid or metal gets into the product, an electric shock and fire are caused. During cleaning, remove the power cord plug from the outlet.

Use the product correctly and safely, observing the above warning and caution items. Because the instruction manual indicates caution items even in individual items, observe those caution items to correctly use the product.

If you have questions or comments about the content of the instruction manual, ask us or E-Mail us.

1. GETTING STARTED

LSC series electronic load appliances are designed for DC power and battery testing, evaluation, and burn-in.

LSC series electronic load appliances can be controlled locally on the front panel or remotely by a computer via GPIB / RS232 / USB / LAN. Discharge modes include constant current (CC) mode, constant resistance (CR) mode, constant voltage (CV) mode, and constant power (CP) mode. Constant current mode takes advantage of a wide range of dynamic loads with independent rising and falling current slew rates and analog programming inputs with arbitrary waveform inputs.



1-1. LSC Series Introduction

1-1-1. Main features

Features	<ul style="list-style-type: none">Voltage, current and power values can be digitally displayed in 5 digits on a large LCD display at the same time.CC, CR, CV, CP, CV + C limit, CV + P limit can be discharged by static mode.CC, CR and CP can be discharged by dynamic mode.The master-slave parallel operation can be used in CC, CR, CV and CP modes.The number of master-slave parallel operations is 1 master machine and 7 slave machines (maximum).Up to 150 types of power-on settings can be selected.The voltmeter display can be set to positive (+) or negative (-) polarity.There are four optional communication interfaces: GP-IB, RS-232C, USB, and LAN.There are 6 types of test functions (Short, OCP, OPP, BMS, Batt and Surge).Turbo mode can withstand up to 1.5 times the current and
----------	--

power electronic load within 2 sec. It can be used in BMS, Short, OCP, OPP test modes.

- There is protection against voltage, current, power and temperature.

1-1-2. Protection function

The protection functions of the LSC series electronic load devices are as follows.

Overvoltage protection (OVP) When the LSC series is in the overvoltage applied state and the OVP circuit is activated, the load is turned off. An OVP message is displayed on the LCD.

When the LSC series is no longer overvoltage, it will be able to load on.

When the LSC series becomes overvoltage applied, load off the LSC series to protect the LSC series, but use it so that the overvoltage circuit of the LSC series does not operate.

The OVP circuit is set to the specified voltage and cannot be adjusted.



Never apply AC voltage or negative voltage (reverse voltage connection) to the input of LSC series. Also, do not apply a DC voltage higher than the voltage of the LSC series OVP. If those voltages are applied to the input of the LSC series, the LSC series may fail. This failure is not covered by the warranty.

Overcurrent protection (OCP) When the current flowing through the LSC series exceeds 104% of the rated current, OCP operates and the load is turned off. When OCP is activated, the LCD will display an OCP message.

Overpower protection (OPP) When the applied power of the LSC series exceeds 105% of the rated power, OPP operates and the load is turned off. When OPP works, the LCD will display an OPP message.

Overtemperature protection (OTP) When the temperature of the heat sink of the LSC series reaches about 90 ° C, the OTP circuit operates and loads off. When the OTP circuit is activated, the LCD will display an OTP message. If an OTP message is displayed, check whether the ambient temperature of the LSC series is 0 to 40 ° C. Also, make sure that the vents on the front and back of the mainframe are not blocked. The LSC series draws in air from the front and exhausts it from the back. Therefore, a space of 30cm or more is required on the back of the LSC series.

After a sufficient cooling period (without OTP display), the LSC series can be loaded on.

Reverse voltage connection When the input of the LSC series is connected in reverse voltage (reverse voltage can be applied), the "-" symbol is displayed on the voltage and current display (when the

voltmeter display is set to positive (+) polarity).

If the voltage and current display shows a "-" symbol, turn off the applied power source and check if the power source and the LSC series are reverse voltage connected.



When the input of the LSC series is connected in reverse voltage, a reverse current that cannot be controlled by the LSC series flows. The LSC series cannot display this current.

The LSC series is designed to allow reverse current to flow up to the maximum rated current, but if the reverse current is larger than the maximum rated current of the LSC series, the LSC series will fail.

If there is a possibility that the LSC series will have a reverse voltage connection, it is strongly recommended to connect the power source to the LSC series via a fuse or the like. The fuse to be used operates at high speed, and the one with the maximum current + 5% rating of the LSC series should be used.

1-2. Accessories

Standard accessories	Description	Qty
LSC series instruction manual	Please download from our website.	
Power cord	It depends on the region and TYPE.	1
Banana plug	For sensing (red: SLS10B)	1
Banana plug	For sensing (black: SLS10B)	1
Pin terminal	For current monitor analog voltage input terminals: PTV1-12	4
HD-DSUB cable	Master-slave parallel operation control cable: 15pin 1.5m	1
Handles (PEL-028)	A pair of handles	1
	Countersunk screw #6-32 L=1/4	4
Rack mount kit (PEL-031)	Rack mount fittings	2
	Countersunk screw #8-32 L=5/16	8
	Screw M4 L=20mm	4
	Hexagon bolt M8 L=25mm	2
Accessory kit for input terminals	Nut M4	4
	Nut M8	2
	Washer DIA-8.5	4
	Spring washers $\Phi 8$	2

PTV1-12

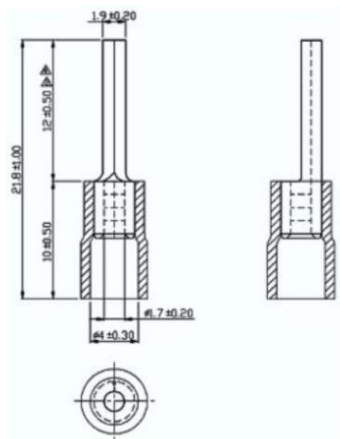

SLS10B

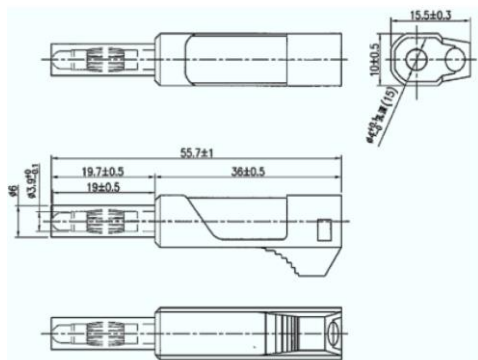

An insulating cover is attached to the conductive part at the tip of SLS10B. When the SLS10B is inserted into the V sense terminal, this cover will slide and the V sense terminal and SLS10B will be in a conductive state.

Optional accessories

Description

PEL-023

RS-232C interface board



PEL-022

GP-IB interface board

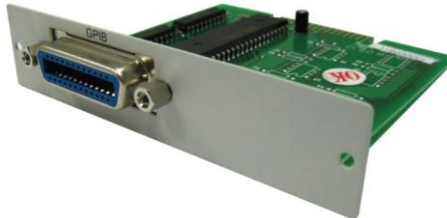

PEL-025

USB interface board



PEL-024

LAN interface board



GTL-232

RS-232C cable

GTL-246

USB cable, 1.2m

GEL-248

GP-IB cable, 2m

GEL-250

GP-IB cable, 1m

1-3. Description of operating mode

1-3-1. CC mode

Description

Constant current (CC) mode is a discharge mode that can be used with a voltage source.

The LSC series flows the load current of the set current value regardless of the input voltage.

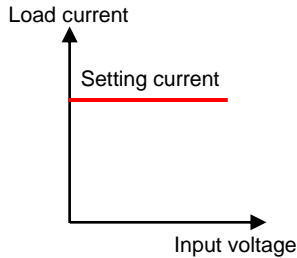

1-3-2. CR mode

Description

Constant resistance (CR) mode is a discharge mode that can be used for voltage and current sources.

For voltage sources

The LSC series controls the load current by dividing the input voltage by the set resistance.

Load current = Input voltage / Setting resistance

For current sources

The LSC series controls the input voltage value by multiplying the current source current by the set resistance.

Input voltage = Current source current x Setting resistance

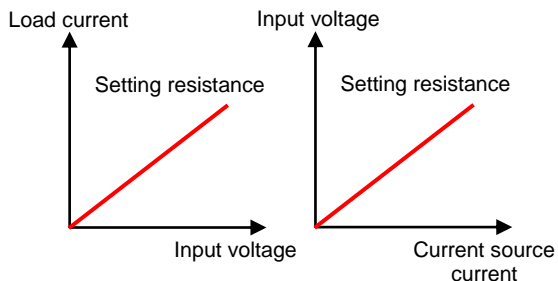

1-3-3. CV mode

Description

Constant voltage (CV) mode is a discharge mode that can be used with a current source.

The LSC series controls the input voltage with the set voltage value regardless of the current source current.

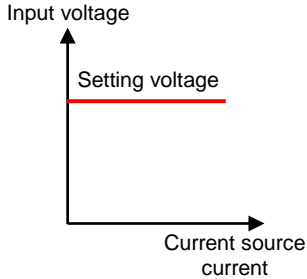

1-3-4. CP mode

Description

Constant power (CP) mode is a discharge mode that can be used with a voltage source.

The LSC series controls the load current by dividing the set power by the input voltage.

Load current = Setting power / Input voltage

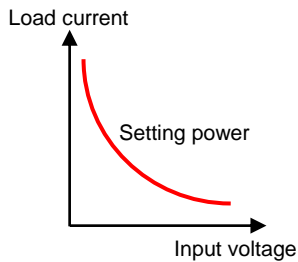

1-3-5. Slew rate

Description

For the LSC series, the rising and falling slew rates of the load current can be set. The slew rate is the amount of change in current over time and the unit is "A/s".

The timing at which the load current flows at the set slew rate is when there is a change in the load setting such as LOAD ON / OFF and dynamic mode.

By setting the load current slew rate appropriately, it is possible to minimize the induced voltage drop in the inductive power supply wiring when the load state is changed from one load setting to another.

The load state change time can be calculated by dividing the current change by the slew rate. The actual load state change time is the time when the current change amount changes from 10% to 90% or 90% to 10%.

Error in load state change time

At the start and end of the load state change (red line in the figure below), the linearity of the load current deteriorates. When the amount of change in the load state is small, there is a part where the linearity of the load current deteriorates within the range of 10% -90% of the load current change.

This phenomenon causes the actual change time to be longer than the expected time based on the slew rate.

In the figure, the load state change is drawn from CCL to CCH, but the same phenomenon occurs when CCH to CCL.

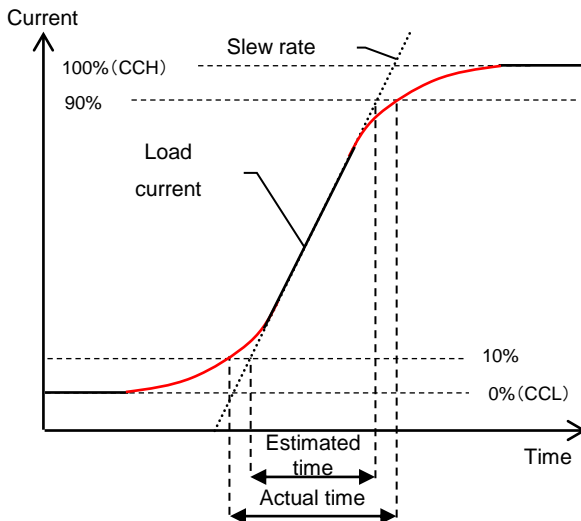

Note

When using the slew rate setting to determine the load state change time, keep in mind that there is a difference between the actual time and the estimated time.

When the amount of change in the load state is large, the

linearity of the load current improves within the range of 10% -90% change in the load current. The time difference between the estimated time and the actual time is small. The Slew rate in the dynamic mode of the LSC series is a specification when the load state change amount is 30% or more of the rated current.

The calculation of load state change time with slew rate settings is described in Estimated Time.

Example

For LSC602-151

Input rating: 150V/600A/6000W (CCH-CCL>600A×30%)

Current slew rate setting: 24A/us

When the load state change amount is 30% of the rated current

$$\text{CCH-CCL} = 600\text{A} \times 30\% = 180\text{A}$$

$$180\text{A} / 24\text{A/us} = 7.5\text{us: Change amount 0-100\%}$$

$$7.5\text{us} \times 0.8 = 6\text{us: Change amount 10-90\% (change time)}$$

When the load state change amount is 100% of the rated current

$$\text{CCH-CCL} = 600\text{A} \times 100\% = 600\text{A}$$

$$600\text{A} / 24\text{A/us} = 25\text{us: Change amount 0-100\%}$$

$$25\text{us} \times 0.8 = 20\text{us: Change amount 10-90\% (change time)}$$

Note

If the slew rate in CC mode is Range I, the CCL setting is at least 0.1% of the rated current.

Setting method

Operate the DYN setting key to set the rising slew rate with RISE and the falling slew rate with FALL. Refer to "2-3-5. DYN Setting key".

1-3-6. Dynamic mode

Description

In addition to static mode, the LSC series can discharge in each mode of constant current (CC), constant resistance (CR) and constant power (CP) by dynamic mode. With dynamic mode, discharge by pulse load is possible.

Dynamic mode can be set from the front panel of the LSC series. The setting status can be saved and recalled in the memory of the LSC series.

Dynamic mode can be manipulated using the optional communication interface. For details on communication commands, refer to "9-3. Remote commands".

Setting method

First, use the Level key to set "High load level" and "Low load level".

Next, operate the DYN Setting key to set "Rise slew rate" and "Fall slew rate" between these two current values. Also

set "T high" and "T low".

Operation method

Operate the DYN / STA key to turn on the DYN / STA key indicator.

Dynamic mode is executed in the LOAD ON state.

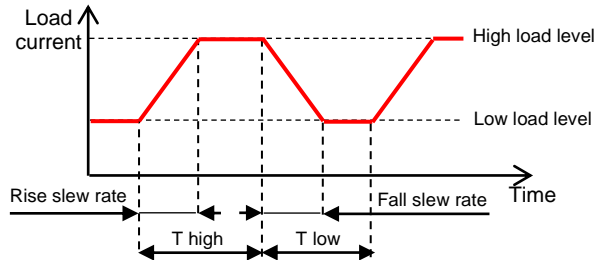

Other dynamic waveform definitions are as follows:

Dynamic mode cycle time: $T_{\text{high}} + T_{\text{low}}$

Dynamic mode frequency : $1 / (T_{\text{high}} + T_{\text{low}})$

Duty cycle: $T_{\text{high}} / (T_{\text{high}} + T_{\text{low}})$

The maximum operating frequency for dynamic mode of the LSC series is 50kHz.

Set "T high" and "T low" so that the following formulas are satisfied.

$$T_{\text{high}} + T_{\text{low}} \geq 20\mu\text{s} (=1/50\text{kHz})$$

$$T_{\text{high}}, T_{\text{low}} \geq 10\mu\text{s}$$

For LSC602-151

Input rating: 150V/600A/6000W (CCH-CCL>600A×30%)

Example 1

Set to CCH = 300A, CCL = 100A

Set to T high = 10us, T low = 10us

Set to Rise slew rate=24A/us, Fall slew rate=24A/us

Rise slew rate and Fall slew rate is;

$$(300\text{A}-100\text{A}) / 25\text{A/us} = 8\mu\text{s}$$

Since the above time (8us) is smaller than T high and T low (= 10us), dynamic mode of CCH = 300A and CCL = 100A is possible at a frequency of 50kHz.

Example 2

Set to CCH=500A, CCL=100A

Set to T high=10us, T low=10us

Set to Rise slew rate=24A/us, Fall slew rate=24A/us

Rise slew rate and Fall slew rate is;

$$(500\text{A}-100\text{A}) / 25\text{A/us} = 16\mu\text{s}$$

Since the above time (16us) is larger than T high and T low (= 10us), dynamic mode of CCH = 500A and CCL = 100A cannot be performed at a frequency of 50kHz.

In this case, set T high and T low to be larger than 16us (for

example, 20us).

However, the frequency of dynamic mode is 25kHz ($= 1 / (20\mu\text{s} + 20\mu\text{s})$).

Note

The LSC series can operate dynamically using the analog voltage input terminal. For details, refer to "3-4. Analog voltage input terminal".

For CC mode

For the purpose of improving the slew rate waveform quality, when the high load level is greater than 0.08% of the rated current value and the low load level is less than 0.08% of the rated current value, the low load level is set to 0.08% of the rated current value.

For CR mode

Dynamic mode works with RANGE I only. If the RANGE II value is set to either Low/High load level, dynamic mode will not be activated.

For CP mode

In static mode, automatic correction operation is performed to achieve the set value, and in dynamic mode, theoretical value operation is performed. Therefore, a difference occurs in the input values of both modes.

1-4. Operating range

1-4-1. LSC402-151, LSC502-151, LSC602-151

LSC402-151

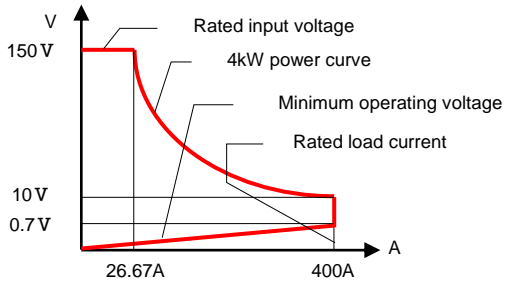

LSC502-151

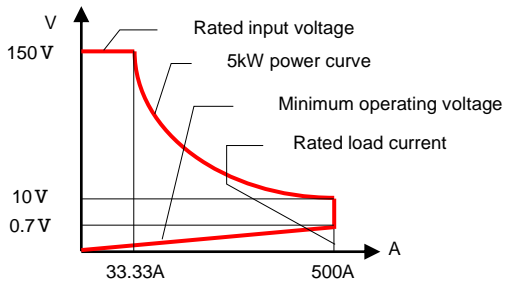

LSC602-151

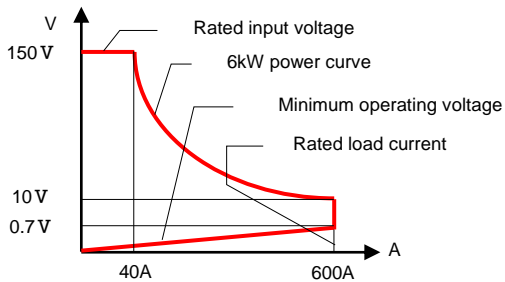

Power rating for ambient temperature

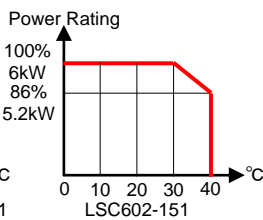
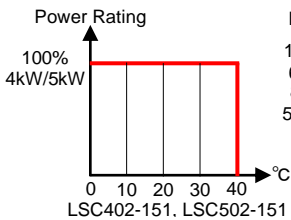

1-4-2. LSC402-601, LSC502-601, LSC602-601

LSC402-601

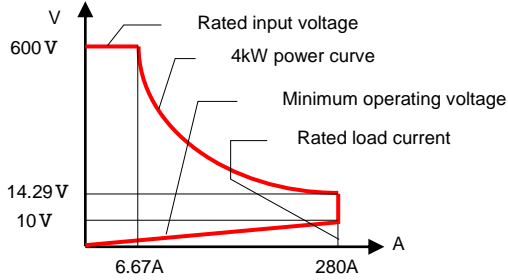

LSC502-601

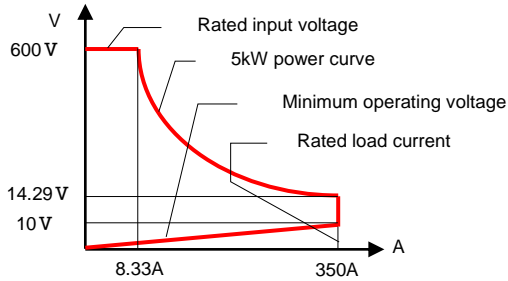

LSC602-601

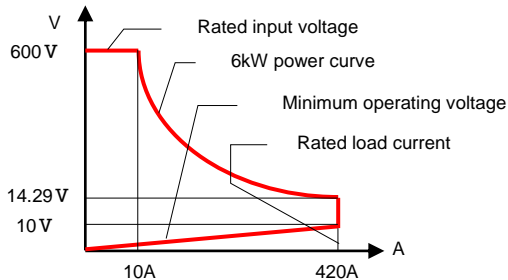

Power rating for ambient temperature

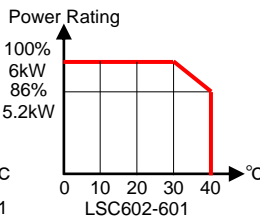
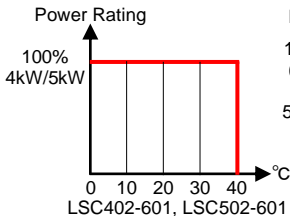

1-4-3. LSC402-122, LSC502-122, LSC602-122

LSC402-122

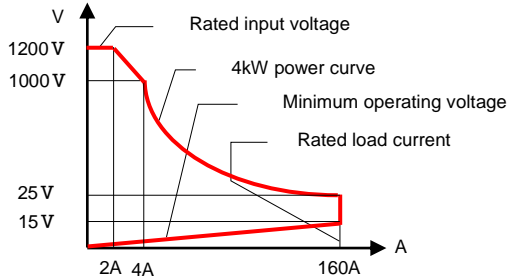

LSC502-122

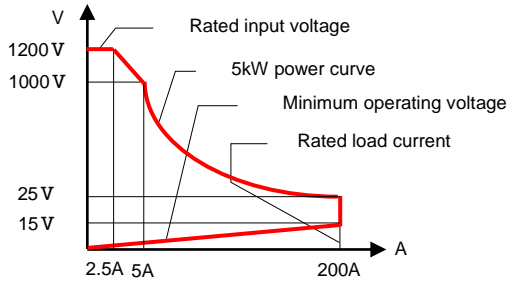

LSC602-122

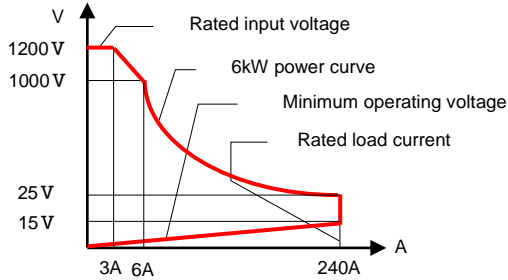

Power rating

For ambient temperature

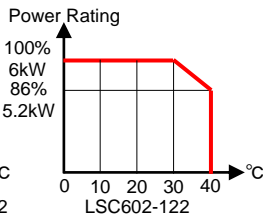
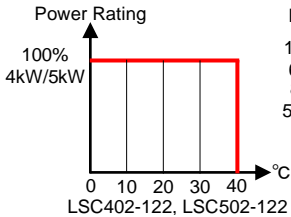

For input voltage

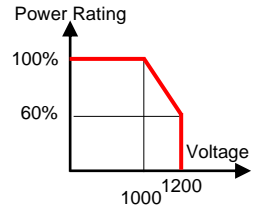

2. Front panel

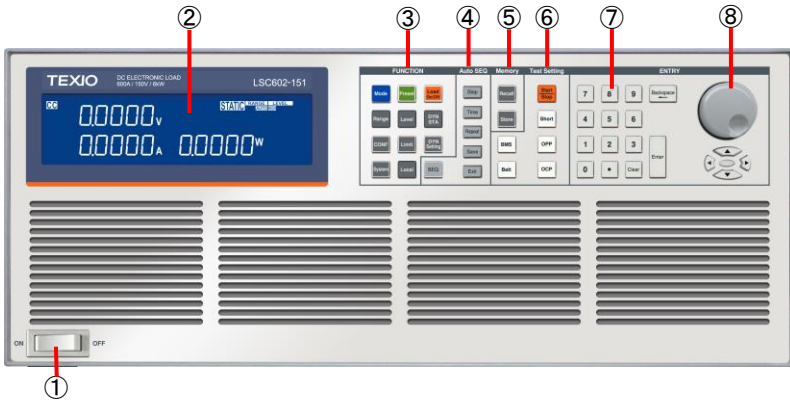

- | | |
|-------------------------------|---|
| 1. Power switch | Refer to "2-1. Power switch". |
| 2. LCD display | Refer to "2-2. LCD display". |
| 3. Function keys | Refer to "2-3. Function keys". |
| 4. Auto sequence keys | Refer to "2-4. Auto sequence keys". |
| 5. Memory keys | Refer to "2-5. Memory keys". |
| 6. Test Setting keys | Refer to "2-6. Test Setting keys". |
| 7. Number keys | Refer to "2-7. Number keys". |
| 8. Rotary knob and arrow keys | Refer to "2-8. Rotary knob and arrow keys". |

2-1. Power switch

It is a power switch of LSC series.

2-2. LCD display

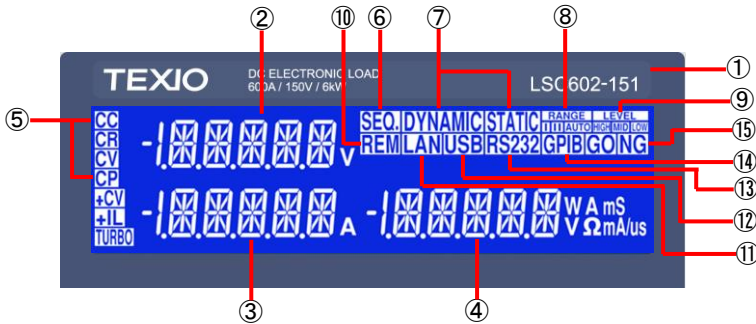

- | | |
|--------------------------------------|---|
| 1. Model number and rated load range | The model number and rated load range (voltage, current, power value) can be found at the top of the LSC series front panel. |
| 2. Left 5-digit LCD display | The 5-digit LCD display is a multifunctional display. The contents displayed on the display change according to the setting mode of the LSC series.
In various settings or AUTO Sequence, the setting items are displayed. |
| Normal display content | This display shows the voltage input to the LSC series input terminal. |
| Note | If the V sense terminal is connected to the device under test (DUT), the displayed voltage value will be the voltage value of the DUT. The load line loss voltage caused by the load current flowing through the load line is not displayed. The voltage value input to the LSC series is smaller than the display voltage by the load line loss voltage. |
| Test function display contents | When any of the Test function keys is pressed, a message related to the selected test function is displayed on this display. |
| Note | During the test, the load input voltage is displayed on this display. |
| 3. Central 5-digit LCD display | The contents displayed on the display change according to the setting mode of the LSC series. |
| Normal display content | This display shows the load current value discharged by the LSC series. |
| Display contents in setting mode | Various settings or AUTO Sequence setting items are displayed. |

4.	Right 5-digit LCD display Normal display content Display contents in setting mode Note	The contents displayed on the display change according to the setting mode of the LSC series. This display shows the power value discharged by the LSC series. In various settings or AUTO Sequence, the setting items are displayed. For the display contents of each (left, center, right) 5-digit LCD display, refer to the contents of various key explanations.
5.	Discharge mode indicator	The LSC series has four discharge modes. These can be selected in order by pressing the MODE key of the LSC series. The indicator lights up depending on the discharge mode selected.
6.	SEQ. Indicator	When the Auto Sequence function is entered, the "SEQ." Indicator lights up.
7.	DYNAMIC / STATIC indicator	The "DYNAMIC" indicator lights up while the DYNAMIC mode is selected, and the "STATIC" indicator lights up while the STATIC mode is selected.
8.	RANGE indicator	The LSC series has two setting ranges (RANGE I, II) in each mode of CC, CR, CV, and CP. When set to RANGE AUTO, the "RANGE AUTO" indicator lights up and the range is automatically switched according to the set value. In CC mode, either the "RANGE II" or "RANGE AUTO" indicator lights up. In discharge modes other than CC mode, the "RANGE AUTO" indicator lights up.
9.	LEVEL indicator	In static mode, the "Low" indicator is lit when "Low load level" is selected, and the "High" indicator is lit when "High load level" is selected.
10.	REM indicator	When the "REM" indicator is lit, the LSC series is operating through one of the optional communication interfaces. While the "REM" indicator is lit, it cannot be set manually on the front panel.
11.	LAN indicator	When the LSC series is controlled by LAN via a PC, the "LAN" indicator lights up.
12.	USB indicator	When the LSC series is controlled by USB via a PC, the "USB" indicator lights up.
13.	RS232 indicator	When the LSC series is controlled by RS232C via a PC, the "RS232" indicator lights up.
14.	GPIB indicator	When the LSC series is controlled by GP-IB via a PC, the "GPIB" indicator lights up.
15.	GO/NG indicator	If the voltmeter, ammeter, or power meter reading exceeds the set limit, the NG indicator lights up.

2-3. Function keys



The LSC series FUNCTION keys are designed for high operability.

2-3-1. MODE key

The discharge mode of the LSC series can be selected.



The LSC series has four types of discharge modes. These can be selected in order by pressing the MODE key.

The selected discharge mode indicator lights up.

The order is as follows:

CC mode

CR mode

CP mode

CV mode

Note

When using the LSC series in CV + C limit and CV + P limit modes, set the values in CC mode and CP mode, then operate the "Limit key" and set the voltage with the "Add.CV" parameter. For "Add.CV", refer to "2-3-8. Limit key".

2-3-2. Load On/Off key

Operate this key to switch between LOAD on and LOAD off for the LSC series.



When the LSC series is LOAD on, the LED indicator of this key lights up.

Press this key while it is off, this key will light up and LOAD will be on.

Press this key while this key is lit, this key goes out and LOAD is turned off.

Note

When LOAD is turned ON, the load current flows through the LSC series according to the set value. The rising characteristic of the load current is the set rising slew rate value.

When LOAD is turned off, the LSC series sets the load current to 0A from the set value. The falling characteristic of the load current will be the set Fall slew rate value.

Even if the LSC series is in the LOAD on state, if the voltage input to the LSC series is less than or equal to the LD on voltage, the LSC series will not be LOAD on.

When the LSC series is in the LOAD on state and the voltage input to the LSC series falls below the LD off voltage, the LSC series is LOAD off.

The LD on and LD off voltage values are set by operating the CONFIG key. The LD off value cannot be set higher than the LD on value.

2-3-3. Preset key

Operate this key to set and check the load value of the LSC series.



Press the Preset key, the LED indicator on the Preset key will light up. Press the PRESET key while the LED indicator is on, the LED indicator will turn off.

When the LED indicator is lit, the right 5-digit LCD display shows the preset value for the selected discharge mode. The displayed preset values are High or Low load level in Static mode, High or Low load level and T high or low in Dynamic mode.

Preset values are set using the number keys, the rotary knob, and the arrow keys.

In static mode, switching between High and Low load levels operates the Level key.

CC mode

As the preset value, the current value in CC mode is displayed, and "A" lights up.

CR mode:

As the preset value, the resistance value of CR mode is displayed, and "Ω" lights up.

CV mode:

As the preset value, the voltage value of CV mode is displayed, and "V" lights up.

CP mode:

As the preset value, the power value of CP mode is displayed, and "W" lights up.

Note

In case of CC, CV, CP mode

The Low load level setting cannot exceed the High load level setting. Also, the High load level setting cannot be lower than the Low load level setting.

In case of CR mode

When using dynamic mode, set the Low and High load levels within the RANGE I range. Dynamic mode cannot be used when the RANGE II range is set for either Low or High load levels.

2-3-4. DYN/STA key

The LSC series switches between static mode and dynamic mode each time the DYN / STA key is pressed. Dynamic mode is possible in CC, CR and CP modes.



When the DYN/STA key is operated and the STATIC indicator on the LCD display lights, the LSC series is in static mode.

When the DYN/STA key is operated and the DYNAMIC indicator on the LCD display lights, the LSC series is in dynamic mode.

Various settings for High and Low load level are made by operating the DYN Setting key.

Note In case of CR mode
Dynamic mode cannot be used when the RANGE II range is set for either Low or High load levels.

2-3-5. DYN Setting key

By pressing the DYN Setting key, set the switching timing of the load current in dynamic mode, set the surge test, and execute the surge test.



Each time the DYN setting key is pressed, the display on the center and right 5-digit LCD display changes. Each setting is set using the number keys, rotary knob, and arrow keys.

The order shown on the display and the corresponding settings are as follows:

State	LCD display	Description
1 T_Hi		Set the setting time of High load level. The unit is "ms".
2 T_Lo		Set the low load level setting time. The unit is "ms".
3 RISE		Set the Rise slew rate. The unit is "us".
4 FALL		Set the Fall slew rate. The unit is "us".
5 SUG. I		Set the surge current when LOAD is ON. The unit is "A".
6 NOR. I		Set the current at the end of the surge current. The unit is "A".

7
S. TIME



Set the time when the surge current ends. The unit is "ms".

8
S. STEP



Sets the number of surge current attenuation steps.

Note

To run the surge test, press the Start/Stop key in step 8 after setting the parameters in steps 5-8. For details, please refer to "7-6. Surge test".

9



Parameter setting is completed by operating the DYN Setting key.

The LED indicator lights up while the above parameters are being set.

Operate the Preset and Level keys to set the preset values for High and Low load level.

Note

For the setting specifications of each parameter, refer to the dynamic mode items and surge test items in "11-2. LSC series Specifications".

2-3-6. Range key

The Range key can only be operated in CC mode. Press the Range key to switch between RANGE II and AUTO.



When RANGE Auto is selected, RANGE AUTO on the LCD display turns on and RANGE I or RANGE II automatically switches depending on the set value. At this time, RANGE I and RANGE II do not light up.

When RANGE II is selected, RANGE II on the LCD display lights up.

Note

The discharge mode other than CC mode is RANGE Auto. RANGE II cannot be selected.

When preset values (High and Low load levels) are set in CC and CP modes in RANGE Auto, the preset value setting resolution automatically changes.

If the preset value is RANGE I, it will be the RANGE I setting resolution. If any one of the preset values is RANGE II, it will be the setting resolution of RANGE II.

This preset value setting resolution automatic change operation may increase or decrease the preset value.

2-3-7. Level key

Pressing the Level key in static mode switches the preset value (High and Low load level) for each discharge mode.



When the Level indicator High on the LCD display lights up, the preset value High load level is selected. When the Level indicator Low lights, the preset value Low load level is selected.

Note

The rising characteristic of the load current when the preset value is switched from Low load level to High load level is the set Rise slew rate value.

The falling characteristic of the load current when the preset value is switched from High load level to Low load level is the set Fall slew rate value.

In case of CC, CV, CP mode

The Low load level setting cannot exceed the High load level setting. Also, the High load level setting cannot be lower than the Low load level setting.

2-3-8. Limit key

Operate the Limit key to setting voltage values in CC/CP+CV mode, upper and lower limits (thresholds for upper and lower limits) of each reading (voltage, current, power), and NG judgment for thresholds.



Each time the Limit key is pressed, the center and right 5-digit LCD displays change. Each setting is set using the number keys, rotary knob, and arrow keys.

The order shown on the display and the corresponding settings are as follows:

State	LCD display	Description
1 Add.CV		Set the CV mode voltage for CV + C/P limit mode. The unit is "V".
2 V_Hi		Sets the upper threshold of the input voltage. The unit is "V".
3 V_Lo		Sets the lower threshold of the input voltage. The unit is "V".
4 I_Hi		Set the upper threshold of the load current. The unit is "A".
5 I_Lo		Sets the lower threshold for the load current. The unit is "A".

6
W_Hi



Sets the upper threshold for input power.
The unit is "W".

7
W_Lo



Sets the lower threshold for input power.
The unit is "W".

8
NG



Set ON / OFF.
When set to ON, NG is displayed on the display when the discharge status of the LSC series exceeds V_Hi / Lo, I_Hi / Lo, W_Hi / Lo.

9



Parameter setting is completed by operating the Limit key.

The LED indicator lights up while the above parameters are being set.

Note

When the discharge mode is CR or CV, there is no Add.CV setting.

Example

In static CC mode, set the V_Hi and V_Lo voltages and turn NG ON.

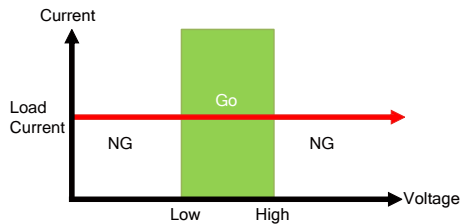

Dynamic mode In CC mode, set the V_Hi and V_Lo voltages and turn NG ON.

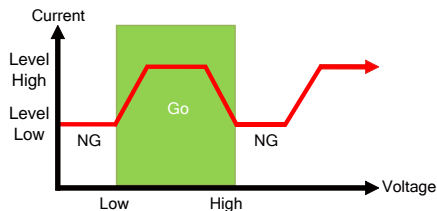

In CR mode, set the V_Hi and V_Lo voltages and turn NG ON.

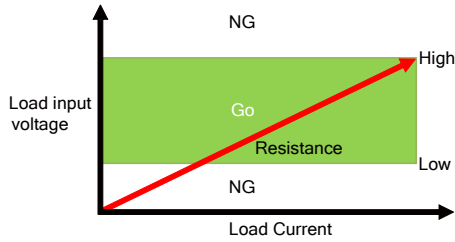

In CV mode, set the I_{Hi} and I_{Lo} currents and turn NG ON.

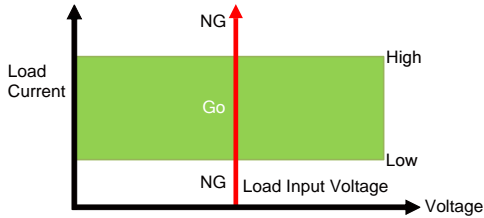

In CP mode, set W_{Hi} and W_{Lo} power and turn NG ON.

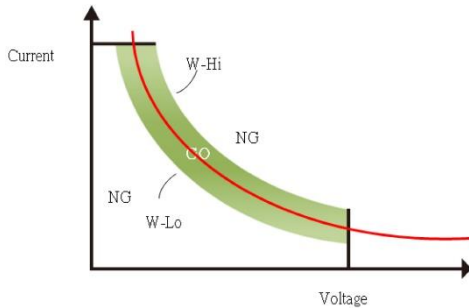

2-3-9. CONF key

Press CONF key to set V-sense function, LOAD ON/OFF setting by input voltage, input voltage polarity setting, MPPT test setting and execution, measurement value averaging setting, turbo mode setting, EXT in setting, CV mode response.



Each time the CONF key is pressed, the center and right 5-digit LCD displays change. Each setting is set using the number keys, rotary knob, and arrow keys.

The order shown on the display and the corresponding settings are as follows:

State	LCD display	Description
1 SENSE		Set ON or AUTO. When set to ON, the voltage value to be displayed is the voltage value from the rear V sense input terminal.

2
LDon



When set to AUTO, the voltage value to be displayed is either the voltage value from the rear V sense input terminal or the rear DC input terminal.

LOAD Set the voltage to turn on. The unit is "V".

When the LSC series is in the LOAD on state and the voltage value from the rear V sense input terminal or rear DC input terminal becomes higher than the LDon voltage, a load current flow.

3
LDoff



LOAD Set the voltage to turn off. The unit is "V".

When the load current is flowing while the LSC series is LOAD on, if the voltage value from the rear V sense input terminal or the rear DC input terminal becomes lower than the LDoff voltage, the load current becomes 0A.

4
POLAR



Select + LOAD or -LOAD to set the input voltage polarity. When + LOAD is selected, the voltage value from the rear V sense input terminal or the rear DC input terminal is displayed as positive.

When -LOAD is selected, the voltage value from the rear V sense input terminal or the rear DC input terminal is displayed as a negative electrode.

5
AVG



Set the average time of each value of voltage / current / power displayed on the LSC series.

6
TURBO



Set OFF or ON.

When set to OFF, the load current of the LSC series will be the rated current.

7
EXTIn



When set to ON, the load current of the LSC series can flow up to 1.5 times the rated current (within 2 seconds).

Set OFF or ON.

When set to OFF, the set value cannot be operated using the analog voltage input terminal on the rear panel.

When set to ON, the setting value using the analog voltage input terminal is superimposed on the setting value of CC and CP mode.

8
CV_bW



Set the response speed in CV mode. The setting range is 1-4, and 4 is the fastest.

This setting can be set only by operating the panel.

9



Parameter setting is completed by operating the Config key.

The LED indicator lights up while the above parameters are being set.

Note

LDon voltage settings are valid in CC, CR, and CP modes. It does not work in CV mode.

The LDon voltage cannot be set lower than the LDoff voltage. When setting the LDon voltage and LDoff voltage to 0V, first set the LDoff voltage to 0V and then set the LDon voltage to 0V.

For the setting specifications of each parameter, refer to the Conf key parameter items in "11-2. LSC series Specifications".



Even if POLAR is set to -LOAD, reverse voltage cannot be connected to the LSC series rear input terminal.







2-3-10. System key

Operate the SYSTEM key to set the GPIB address, RS232 baud rate, various setting states of the LSC series when the power is turned on, the judgment buzzer sound at the end of AUTO Sequence, and master-slave parallel operation.



Each time the System key is pressed, the center and right 5-digit LCD displays change. Each setting is set using the number keys, rotary knob, and arrow keys.

The order shown on the display and the corresponding settings are as follows:

State	LCD display	Description
1 GPIb Addr		Set the GPIb address in the range 1-30.
2 RS232 bAUd		Set the baud rate of RS232. Set the baud rate to 9.6k, 19.2k, 38.4k, 57.6k, or 115.2k. The unit is "bps".
3 WAKE UP		The LSC series can save 150 types of various setting states to the memory in the LSC series. When the power is turned on, set the various setting states in the range of 0 to 150. When 0 is set, there is no recall of various setting values at power-on.
4 Seq. bEEP		Set the judgment buzzer sound at the end of AUTO Sequence to ON or OFF. When set to ON, If the AUTO Sequence result is PASS, the buzzer sounds once, and if it is FAIL, the buzzer sounds twice. When set to OFF, There is no buzzer regardless of the AUTO Sequence result.
5 CTRL	  	Select the state in which the LSC series will be used. <ul style="list-style-type: none"> • ALONE: Independent operation • MASTER: Master-slave parallel operation master machine • SLAVE: Master-slave parallel operation slave machine 1-7 In the SLAVE display, 1-7 is displayed on the right display.

6



Parameter setting is completed by operating the System key.

After setting each of the above parameters, press the ENTER key to save each parameter in the LSC series. Press the ENTER key for each parameter setting.

2-3-11. Local key



While using the LSC series on the communication interface, pressing the Local key enables the LSC series to be operated from the front panel.

2-4. Auto sequence keys



Operate the Auto sequence keys to set and execute the LSC series AUTO Sequence function.

For the operation method of each key, refer to "8. Description of AUTO Sequence function".

2-5. Memory keys

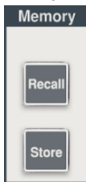

Various setting states of 150 can be saved in the EEPROM memory built into the LSC series. In addition, 150 types of various setting states can be recalled.

Note Various test functions cannot be saved or recalled.

2-5-1. Recall key



Press the Recall key to recall any of the 150 types of settings. Use the number keys, rotary knob, and arrow keys to set the numbers in various setting states.

- 1 Press the Recall key.
- 2 Set the numbers of various setting states in the range 0-150.
- 3 After that, press the ENTER key, the LSC series will be in various setting states of the setting number.



When operating the Recall key, make sure that various test functions are not operating.
Be careful not to short the DUT when recalling the LOAD ON configuration state.

2-5-2. Store key



Press the Store key to save various setting states to the LSC series with an arbitrary number of 1-150.

Use the number keys, rotary knob, and arrow keys to set the numbers in various setting states.

- 1 Operate the panel and set various setting states you want to save.
- 2 Set the save destination number of various setting states in the range 0-150.
- 3 After that, press the ENTER key, the current various setting states are saved in the save destination number.

2-6. Test Setting keys

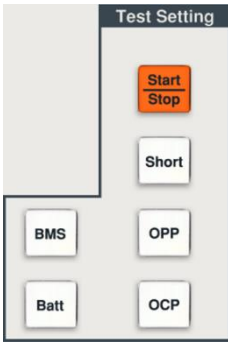

Operate the Test Setting keys to set and execute each LSC series (Short, OPP, OCP, BMS, Batt) test.

For the operation method of each key, refer to "7. Test functions description and operation".

2-7. Number keys

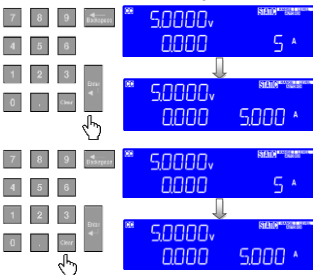

Enter a number and press Enter to confirm.

Press the Clear key to clear the input value.

Note The preset value for each discharge mode is set according to the setting resolution.

2-8. Rotary knob and arrow keys

Rotary knobs and arrow keys are used to increase or decrease the set value.

Turn the rotary knob clockwise or press the up arrow key to increase the setting.

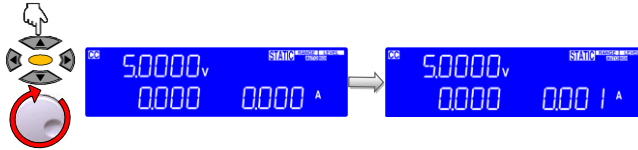

Turn the rotary knob counterclockwise or press the down arrow key to decrease the set value.

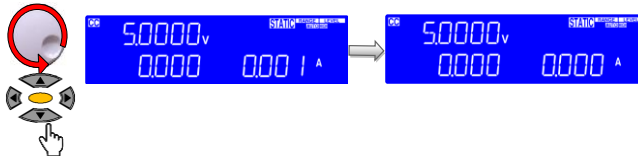

Note

In CR mode, turning the up-arrow key or rotary knob clockwise decreases resistance, and turning the down-arrow key or rotary knob counterclockwise increases resistance.

The CR and CV mode preset values are set according to the set resolution.

The preset value in CC and CP mode can be increased or decreased by setting digits, but the preset value is set according to the setting resolution.

3. Rear panel

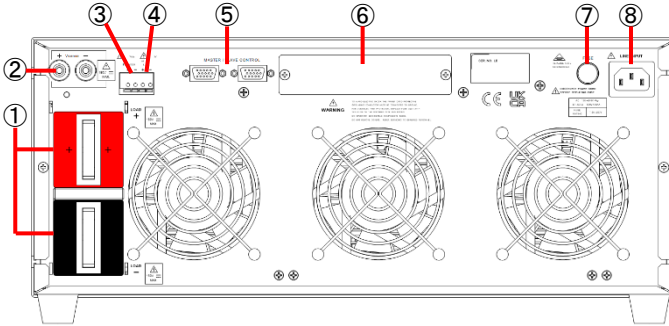

- | | |
|-----------------------------------|---|
| 1. DC input terminal | Refer to "3-1. DC input terminal". |
| 2. V sense terminal | Refer to "3-2. V sense terminal". |
| 3. Current monitor terminal | Refer to "3-3. Current monitor terminal". |
| 4. Analog voltage input terminal | Refer to "3-4. Analog voltage input terminal". |
| 5. Master-slave control connector | Refer to "3-5. Master-slave control connector". |
| 6. Communication interface slot | Refer to "3-6. Communication interface slot". |
| 7. Fuse | Refer to "3-7. Fuse". |
| 8. AC power input terminal | Refer to "3-8. AC power input terminal". |

3-1. DC input terminal

Description The positive (LOAD +) and negative (LOAD-) terminals indicate the polarity and input rating. As shown in the figure below, connect the LOAD + terminal to the DUT output positive terminal and the LOAD- terminal to the DUT output negative terminal.

Note If necessary, ground this terminal. For a positive output DUT, ground the LOAD- terminal. For a negative output DUT, ground the LOAD + terminal.



Make sure that the output rating of the DUT connected to this terminal does not exceed the maximum input rating of the LSC series. Also, be careful not to make a reverse voltage connection between the DUT output terminal and this terminal.

If the current monitor terminal is used with this terminal grounded or the output of the grounded DUT connected to this terminal, this terminal may be short-circuited.

Do not mistake this terminal for the V sense terminal.

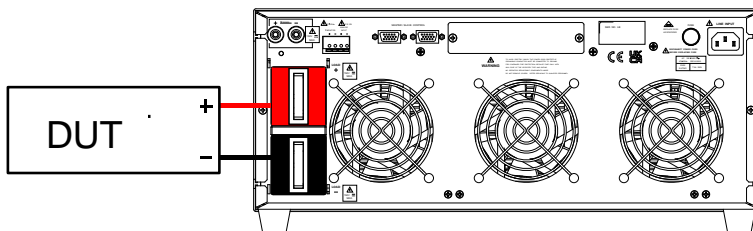

Connection between DUT output terminal and this terminal



WARNING

Voltage is input from DUT to the DC input terminal of the LSC series. Attach the terminal cover so that it does not come in contact with the DC input terminal.

3-2. V sense terminal

Description A voltage drop occurs when a current flows through the load line between the DUT output terminal and the DC input terminal. When this terminal is connected to the DUT output terminal (remote sense connection), the LSC series performs discharge that compensates for the voltage drop. In this case, the voltage display shows the output terminal voltage of the DUT.

Polarity is indicated on the positive (V sense +) and negative (V sense-) terminals. When making a remote sense connection, connect the V sense + terminal to the DUT output positive terminal and the V sense- terminal to the DUT output negative terminal. The voltage rating of this terminal is the same as that of the DC input terminal.

Use this terminal by inserting a banana plug (Φ4) with a sensing wire attached to the supplied banana plug (red, black).

Note Operate the Config keys to select AUTO or ON in the SENCE item.
SENCE "ON" setting

When the DUT and LSC series are connected for remote sense, the voltage display of the LSC series will be the DUT output. If the DUT and LSC series are not connected for remote sense, the LSC series will not detect the DUT output terminal voltage.

SENCE "AUTO" setting

When the DUT and the LSC series are connected in remote sense and the V sense terminal voltage is higher than the voltage below, the voltage display of the LSC series will be the DUT output.

150V model: 1.75V, 600V model: 7V, 1200V model: 14V

When the DUT and the LSC series are not connected for remote sense, the LSC series will be the DC input terminal voltage.



Do not connect the V sense + terminal to the DUT output negative terminal and the V sense- terminal to the DUT output positive terminal. The LSC series may break down.

If SENCE is set to "ON" and the DUT and LSC series are not connected for remote sense, the LSC series will not detect the DUT output terminal voltage.

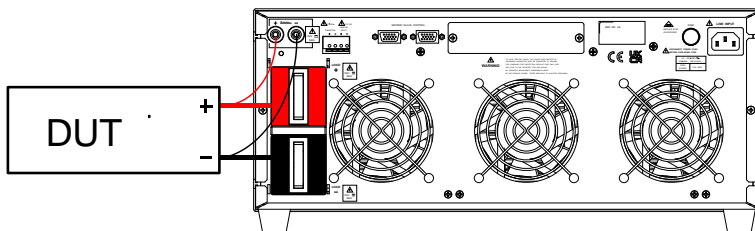

DUT output terminal Connect the Japanese terminal (remote sense connection)

3-3. Current monitor terminal

Description The current monitor terminal outputs the load current of the LSC series as a voltage. The polarity is displayed on this terminal. The voltage value output from this terminal is 0-10V with respect to the load current 0A --- rated current.

Use the attached pin terminal (PTV1-12) for this terminal.



The negative electrode side of this terminal is connected to the LSC series LOAD-terminal in a circuit. If the input terminal of this unit is grounded or the output of the grounded DUT is connected to this input terminal, the input terminal of the LSC series may be short-circuited.

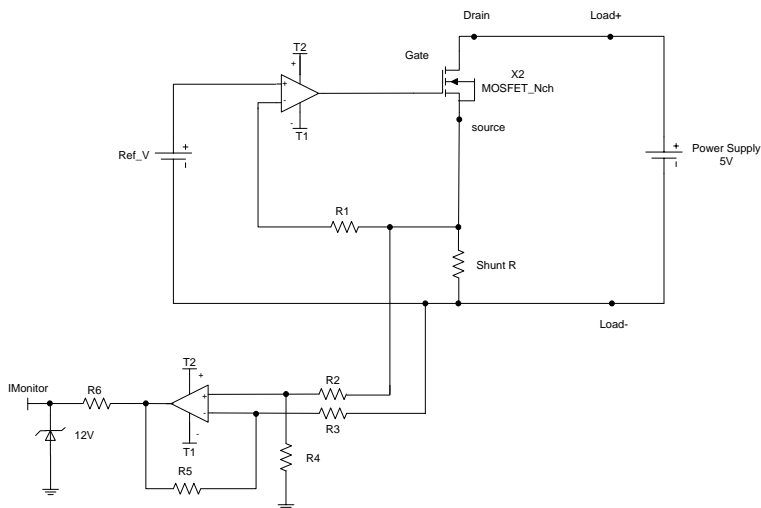

Current monitor equivalent circuit

When connecting the LSC series to an oscilloscope, make sure that the polarity of the connection probe is correct, as shown in the figure below.

(correct)
How to connect
to an
oscilloscope

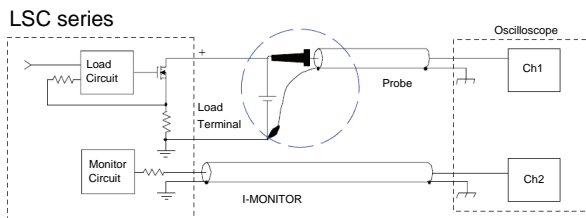

(mistaken)
How to connect
to an
oscilloscope

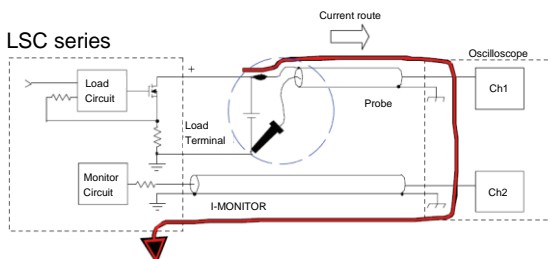

WARNING

Reversing the probe connections as described above can cause large currents to flow through the probe and damage the oscilloscope's internal circuitry.

3-4. Analog voltage input terminal

Description When EXTin is set to ON, the set value using the analog voltage input terminal is superimposed on the CC and CP mode set values of the LSC series.

When using only this pin to operate the set value of each discharge mode, set the set value in the LSC series to CC 0A and CP 0W.

Polarity is displayed on this terminal, and the voltage value that can be input is 0-10V. 0A/0W is set at an input voltage of 0V, and the rated current/power value is set at an input voltage of 10V.

Use the attached pin terminal (PTV1-12) for this terminal.

Note To use this terminal, operate the Config key and select ON in the EXTin item.

The only discharge modes that can use this terminal are CC and CP.

The setting value in the LSC series is the setting value set by using the front panel operation and the communication interface.



The settings for CC and CP modes using this pin are not displayed on the LCD display.

The CC and CP mode settings using this terminal are not displayed on the LCD display.

3-5. Master-slave control connector

Description Used for master-slave parallel operation.
For details, refer to "5-2. Control connector connection method".

3-6. Communication interface slot

Description Install the optional communication interface.
For details, refer to "9-1. Interface configuration".

3-7. Fuse

Description LSC series AC fuse.
For details, refer to "4-1. Power supply voltage check and AC fuse".

3-8. AC power input terminal

Description Install the AC power cable.
For details, refer to "4-1. Power supply voltage check and AC fuse".

4. Setup

4-1. Power supply voltage check and AC fuse

Description The power supply voltage to be input to the AC power input terminal is printed on the back panel.
There is a fuse holder next to the AC power input terminal, which contains an AC fuse. The AC fuse rating is also printed on the back panel.

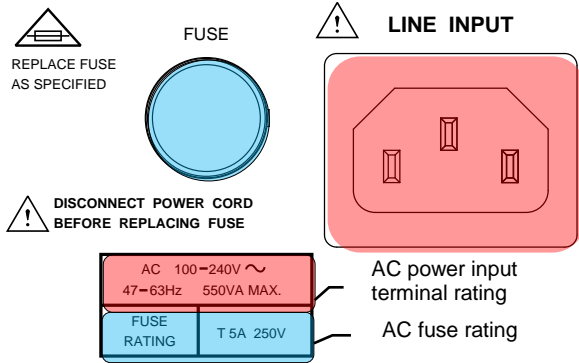

WARNING

When replacing the AC fuse, be sure to unplug the power cord from the AC power input terminal.

4-2. Necessity of grounding

Description The central pin of the LSC series AC power input terminal is connected to the LSC series chassis. Attach the attached power cord to the LSC series and ground the ground terminal on the outlet side to ground the LSC series chassis.

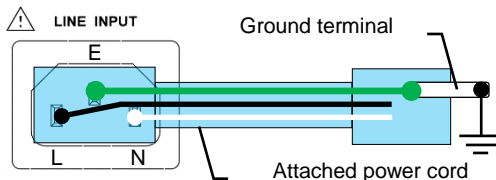

WARNING

To avoid the danger of electric leakage, ground the LSC series chassis before use.

4-3. Power on

- Procedure**
1. Turn off the power switch.
 2. Make sure the power cord is attached correctly.

3. Make sure that no voltage is input from the DUT output to the DC input terminal of the LSC series.
4. Turn on the power switch.

4-4. Connection to DC input terminal

Procedure

1. Set the LSC series to Load Off.
2. Make sure the EUT output is turned off.
3. Connect the output terminal of the DUT and the DC input terminal of the LSC series with a load line, etc.



Make sure that the EUT output and DC input terminal are not connected in reverse voltage.

Note

In order to reduce the influence of the inductance component of the load line, it is recommended that the load line be as short as possible and twisted. In addition, by slowing the rising and falling slew rates of the load current, the influence of the inductance component of the load line can be reduced. For details, refer to "4-8. Effect of load line inductance component".

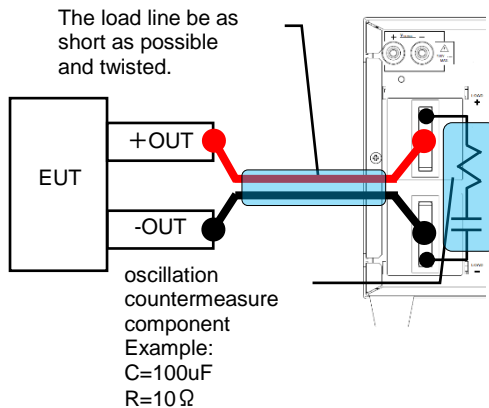

If necessary, attach an oscillation countermeasure component (C and R are connected in series) to the LSC series DC input terminal.



WARNING

Voltage is input from EUT to the DC input terminal of the LSC series. Attach the terminal cover so that it does not come in contact with the DC input terminal.

Attaching accessory kit for input terminals

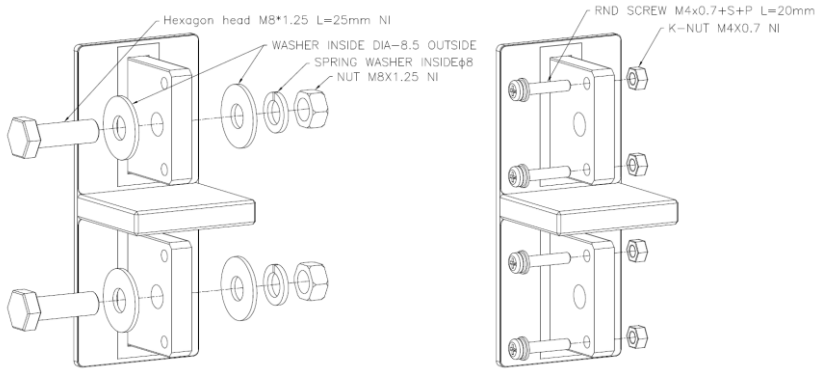

4-5. Connection to V sense terminal

Description When this terminal is connected to the EUT output terminal (remote sense connection), the LSC series performs discharge that compensates for the load line voltage drop.

Procedure

1. Set the LSC series to Load Off.
2. Make sure the EUT output is turned off.
3. Connect the V sense + terminal to the DUT output positive terminal and the V sense- terminal to the EUT output negative terminal. Use this terminal by inserting a banana plug (Φ4) with a sensing wire attached to the supplied banana plug (red, black).

Note "AUTO2 or "ON" can be selected in the SENCE item of the "Config key" operation.



Make sure that the EUT output and the V sense terminal do not have a reverse voltage connection.

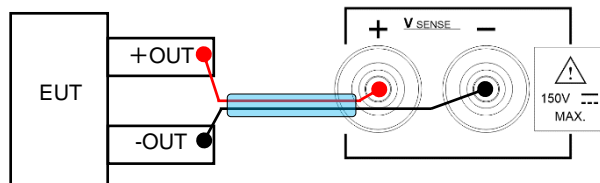

This terminal is susceptible to noise. Do not leave a distance between the remote sense (red and black) wires connected to the V sense terminal of the LSC series. It is recommended to twist the remote sense line in the blue part of the above figure.

4-6. Connection to analog I / O terminal

4-6-1. Current monitor terminal

Description	This terminal can observe the load current flowing through the LSC series.
Procedure	<ol style="list-style-type: none"> 1. Set the LSC series to Load Off. 2. Make sure the EUT output is turned off. 3. Connect this terminal to a measuring instrument (oscilloscope or DMM). Use the attached pin terminal (PTV1-12) for this terminal.
	<p>The negative electrode side of this terminal is connected to the LSC series LOAD-terminal in a circuit. Depending on the grounding condition of the load current measuring instrument, the LSC series DC input terminal may be short-circuited.</p>

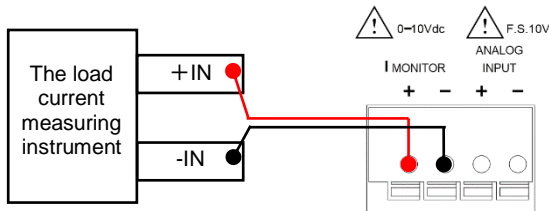

4-6-2. Analog voltage input terminal

Description	Input the voltage from the external power supply to this terminal to operate the LSC series CC and CP mode settings.
Procedure	<ol style="list-style-type: none"> 1. Set the LSC series to Load Off. 2. Make sure the output of the external power supply is turned off. 3. Connect the external power output to this terminal. Use the attached pin terminal (PTV1-12) for this terminal.
Note	<p>When using this terminal, operate the "CONF key" to set the EXTin item to ON.</p> <p> Make sure that the voltage input to this terminal is in a floating state. If a voltage is input to this terminal with a power supply whose output is grounded, the DC input terminal of the LSC series may be short-circuited and the LSC series may fail.</p> <p>Even if the LSC series is in the LOAD off state, if a voltage is applied to this terminal, the LSC series will operate to pass the load current. When turning off the LOAD of the LSC series, set the applied voltage of this terminal to 0V.</p>

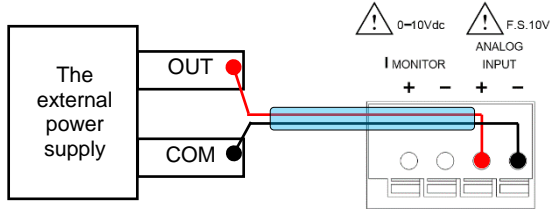

It is recommended to twist the wire in the blue part in the above figure so that it will not be affected by external noise.

4-7. Communication interface

Description When operating the LSC series using a PC, the communication interface of the optional accessory is required. There are 4 types of communication interfaces, and GP-IB, RS-232C, USB, and LAN can be used. Refer to "1-2. Optional accessories for accessories".

- Procedure**
1. Turn off the power switch of the LSC series.
 2. Install the communication interface in the communication interface slot on the back panel.
 3. Turn on the power switch of the LSC series.



WARNING

To attach or remove the communication interface to the LSC series, turn off the power switch. To use the communication interface, it is necessary to set the LSC series and install the driver and application on the PC. USB and LAN drivers and applications can be downloaded from our website.

GPIB The GP-IB address number (1-15) is selected in the GPIb item by operating the System key.

Note The maximum number of devices including a controller (PC, etc.) is 15.

The maximum length of the GP-IB cable is 20m. Also, the GP-IB cable between devices is less than 2m.

RS232C The baud rate is selected by operating the System key and using the RS232 item. For the RS232C connector (female), refer to "9-1-1. RS-232C configuration".

USB Install the USB driver on the PC. Refer to "9-1-3. USB configuration".

LAN Install the dedicated application on the PC. Refer to "9-1-4. LAN configuration".

4-8. Effect of load line inductance component

The load line has inductance. Due to the sudden change in load current, a large voltage is generated across the load line. This voltage is applied to the LSC series DC input terminals. The voltage generated by the inductance of the load line and the change in load current is expressed by the following equation.

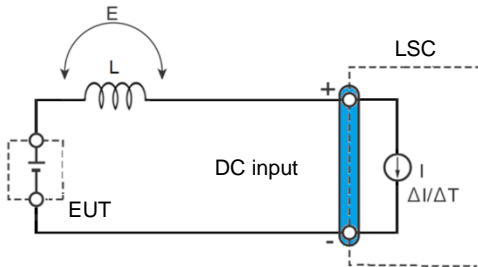

$$E = L \times (\Delta I / \Delta T)$$

E : Voltage generated by load line inductance

L : Load line inductance

ΔI : Amount of Current variation

ΔT : Variation period of current

Generally, the inductance of the wire is about 1uH per 1m. If the EUT and LSC series are connected with a 10m load line and there is a current fluctuation of 2A / us, the voltage generated by the inductance of the load line will be 20V. This is the voltage at which inductance is generated by the magnetic field generated by the sudden change in load current.

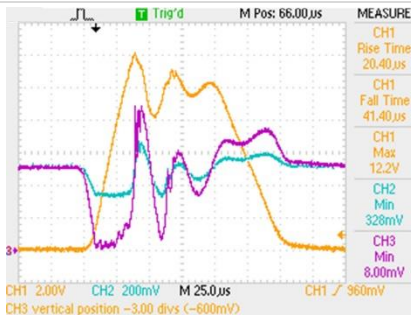

The photo on the left shows the EUT output voltage and DC input terminal voltage when a pulsed load current flows.

CH1: I monitor

CH2: EUT output Voltage (x10)

CH3: LOAD Input Voltage (x10)

Voltage overshoot and undershoot occur at the EUT output and DC input terminals.

If the voltage overshoot is large, overvoltage will be applied to the EUT and LSC series. In this case, it may cause a failure of EUT and LSC series.

If the voltage undershoot is large, the input voltage to the LSC series will be smaller than the minimum operating voltage of the LSC series. In this case, unstable oscillation may occur in the LSC series.

There are the following methods to reduce the voltage generated by the load line inductance.

1. Make the load line as short as possible.

By shortening the load line, the inductance value of the load line can be reduced.

2. Twist the positive and negative load lines.

When the load line is twisted, the magnetic field generated by the sudden change in the load current becomes smaller. By reducing the generated magnetic field, the generated voltage can be reduced.

3. Set the slew rate to a small value.

By setting the slew rate small, the load current fluctuation can be reduced. By reducing the load current fluctuation, the generated voltage can be reduced.

4-9. Rack mount kit installation

As shown in the diagram below, secure the included rack mount kit to the side holes (8 locations) on the front of the device from the left and right with flat head screws (#8-32 L=5/16).

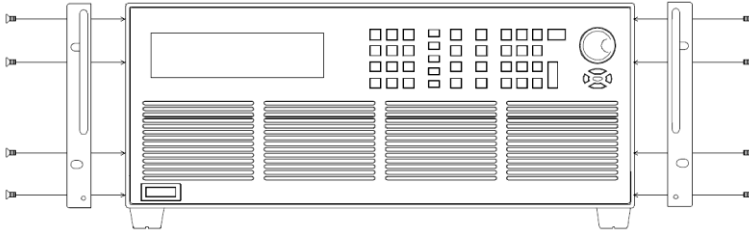

By attaching a rack mount kit to the LSC series, it can be mounted in a rack. The LSC series is a heavy item, so the rack requires rails, etc. If necessary, attach the handle (PEL-028) to the rack mount kit before use. The image above shows a rack mount kit with a handle attached.

5. Description of master-slave parallel operation

The master-slave parallel operation of the LSC series can be used by connecting one master machine and up to seven slave machines in parallel.

Master-slave parallel operation is possible in each discharge (CC, CR, CV, CP) mode, but the following operations are not possible.

Test function (Short test, OCP test, OPP test, BMS test, Batt test, surge test)

Add.CV setting

Auto sequence function

LSC series Store and Recall with various settings status

Set value operation by analog voltage input terminal

5-1. Master machine and slave machine settings

The setting method is selected by operating the System key and using the CTRL item. Refer to “2-3-10. System key”.

Select ALONE to use the LSC series as a stand-alone operation.

When MASTER is selected, the LSC series can be used as a master machine for master-slave parallel operation.

When SLAVE1-7 is selected, the LSC series can be used as a slave machine for master-slave parallel operation. For slave units, select different numbers in order from SLAVE1.

Select the above contents and press the ENTER key, the settings will not be lost even if the power switch is turned off, and this parameter will be saved.

Note

Master-slave parallel operation is only for the same model. Master-slave parallel operation is not possible between different models. The left and right keys cannot be used for master-slave parallel operation.

5-2. Control connector connection method

Use the included cable (HD-DSUB 15pin 1: 1) to connect the master-slave control connector on the back panel of the master and slave machines.

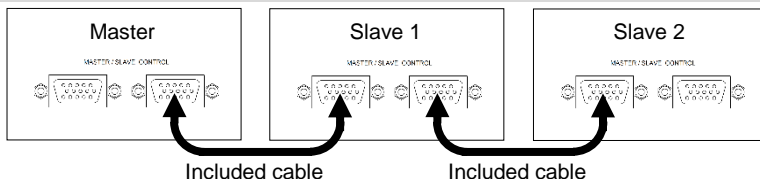

Do not use a commercially available VGA cable as it will short the internal pins 4-8, 11 and the chassis.

5-3. Load line connection

Connect the load lines so that the voltage drop between the DC input terminal and DUT output of each LSC series (master machine and slave machine) is as equal as possible.

Connection example: When connecting each LSC series and DUT with separate load lines

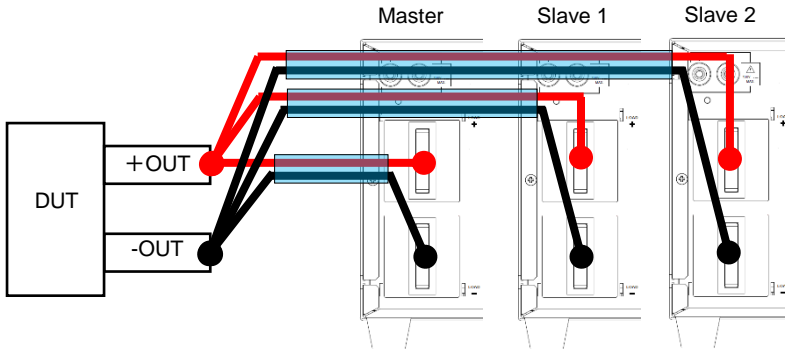

Use the same load line with the same thickness and length.

For the positive and negative (red and black) load lines connected to the DC input terminals of each LSC series, it is recommended to twist the positive and negative load lines in the blue part in the above figure.

5-4. Remote sense line connection

When connecting the V sense terminal to the DUT output by remote sense, connect the V sense terminal of all LSC series to the DUT output.

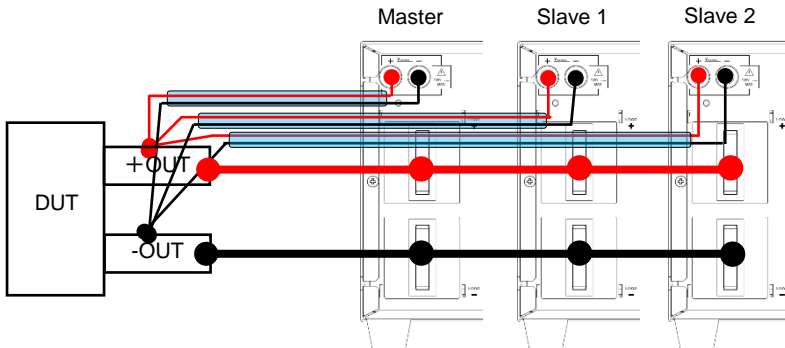

For the remote sense (red and black) wires connected to the V sense terminal of each LSC series, it is recommended to twist the remote sense wire in the blue part in the above figure.

5-5. Power Switch ON / OFF

Turn on Turn on the power switch of the slave machine, and then turn on the power switch of the master machine.
The master machine automatically detects if there is a slave machine.

Turn off Turn off the power switch of the master machine, and then turn off the power switch of the slave machine.

5-6. Display of master machine and slave machine

Master	The current and power display is total current and total power. The preset values (setting values for each discharge mode) displayed by pressing the Preset key are also the total current and total power. The voltage is displayed only on the master machine.
Slave	The current and power display is the value that each slave unit discharges. The preset value (setting value for each discharge mode) displayed by pressing the Preset key is also the setting value for each slave machines. The left LCD display shows SL1 - SL7.

5-7. Available remote commands

The remote commands that can be used in master-slave parallel operation are listed below.





For details on each command, refer to "9-3. Remote commands".

Command name	Brief description
MODE	Discharge mode selects
RISE	Rise of slew rate
FALL	Fall of slew rate
PERI:HIGH	Dynamic mode Thigh time
PERD:LOW	Dynamic mode Tlow time
LDONv	LOAD on voltage
LDOFv	LOAD off voltage
{CC CURR};{HIGH LOW}	CC mode current value
CP:{HIGH LOW}	CP mode power value
{CR RES};{HIGH LOW}	CR mode resistance value
{CV VOLT};{HIGH LOW}	CV mode voltage value
SENSe	Remote sense connection selects
LEVel	Static mode level selects
DYNamic	Dynamic mode level selects
LOAD	Select LOAD on / off
MEASure:CURRent	Load current reedback
MEASure:VOLTage	Input voltage reedback
MEASure:POWer	Input power reedback
REMOTE	Remote state setting
LOCAL	Local state setting

6. Basic operation method



6-1. Static mode

6-1-1. CC, CR, CP, CV mode



Operation	Description
1 Select discharge mode	 <p>Operate the “Mode key” to select the LSC series discharge mode. Four types of discharge modes can be selected: CC, CR, CP, and CV. Refer to “2-3-1. MODE key”.</p>
2 Select range	 <p>When the discharge mode of the LSC series is CC mode, operate the “Range key” to select either AUTO or RANGE II. If the discharge mode is other than CC mode, there is no need to select a range. Refer to “2-3-6. Range key”.</p>
3 Select level	 <p>Operate the “Level key” to select the preset values (High and Low load level) for each discharge mode. Refer to “2-3-7. Level key”.</p>
4 Load value setting	 <p>Use the number keys, the rotary knob, and the arrow keys to set the load value. When the Preset key is operated and the LED indicator of the Preset key is lit, the set load value is displayed on the LDC. Refer to “2-3-3. Preset key”.</p>
5 LOAD on	 <p>Operate the LOAD On / Off key to turn the LOAD On / Off key from the off state to the on state. With the LOAD On / Off key lit, the LSC series will be LOAD on.</p>
6 LOAD off	<p>Operate the LOAD On / Off key to change the LOAD On / Off key from the lit state to the off state. When the LOAD On / Off key is off, the LSC series is LOAD off.</p>



6-1-2. CV+C/P limit mode

Operation	Description
1 Select discharge mode	 <p>Operate the “Mode key” to set to CC or CP mode. When operating the LSC series in CV + C limit mode, set it to CC mode. When operating the LSC series in CV + P limit mode, set it to CP mode. Refer to “2-3-1. MODE key”.</p>

- 2
Load value setting
Set the load value in CC or CP mode.
Set the CC or CP mode load value to High load level, and select the preset value to High load level. Set the Low load level to the lowest setting.
Use the number keys, the rotary knob, and the arrow keys to set the load value.
- 3
CV value setting
 Operate the "Limit key" and set the voltage value in the Add.CV item.
Refer to "2-3-8. Limit key".
- 4
LOAD on
 With Add.CV displayed, press the "Start/Stop key" to start CV + C/P limit mode operation.
If the LOAD is turned on by pressing the Load On/Off key, the instrument will malfunction.
- 5
Load value and CV value setting
When setting the load value and CV value while LOAD is on, operate the "Preset key and Limit key".
Press the "Preset key" to set the load value.
Press the "Limit key" to set the CV value.
- 6
LOAD off
Pressing the "Start/Stop key" while operating in CV + C/P limit mode will stop the operation in CV + C/P limit mode.
- Note
This mode assumes battery discharge. If it is used for purposes other than discharging the battery, or if voltage is applied to the device while it is operating in this mode with no voltage applied to the device input, it may not operate normally.
Refer to "10-6. CV+C limit mode" and "10-7. CV+P limit mode" for the activity of this mode.

6-2. Dynamic mode

Operation	Description
1 Select discharge mode	 Operate the Mode key to select the LSC series discharge mode. Three types of discharge modes, CC, CR, and CP modes, can be selected. Refer to "2-3-1. MODE key".
2 Select range	 When the discharge mode of the LSC series is CC mode, operate the "Range key" to select either AUTO or RANGE II. If the discharge mode is CP mode, there is no need to select a range. Refer to "2-3-6. Range key".
3 Load value setting	 Use the Level key, number key, rotary knob, and arrow keys to set the load value to the Preset value (High and Low load level) of each discharge mode. Set two types of load values,

- 4
Operating
condition setting
- 
- High and Low load level.
Refer to “2-3-7. Level key”.
Operate the “DYN Setting key” to set “T_Hi”,
“T_Lo”, “RISE”, “FALL”.
Refer to “2-3-5. DYN Setting key”
- 5
LOAD on
- 
- Operate the LOAD On / Off key to turn the
LOAD On / Off key from the off state to the on
state. With the LOAD On / Off key lit, the LSC
series will be LOAD on.
- 6
Dynamic mode
on
- 
- Operate the “DYN / STA key” to turn the “DYN /
STA key” from the off state to the on state. With
the “DYN / STA key” lit, the LSC series will
operate dynamically.
Refer to “2-3-4. DYN/STA key”
- 7
LOAD off
- Operate the LOAD On / Off key to change the LOAD On / Off
key from the lit state to the off state. When the LOAD On / Off
key is off, the LSC series is LOAD off.
- Note
- The order of operation 5 (LOAD on) and operation 6 (Dynamic
mode on) can be reversed.
Refer to “1-3-5. Slew rate” and “1-3-6. Dynamic mode” for the
activity of this mode.

7. Test functions description and operation

The LSC series has a test function for Short, OCP, OPP, BMS, Batt and Surge.

7-1. Short test

In this test, in order to confirm the short-circuit protection operation of the UUT, the LSC series operates so as to pass the maximum load current. This test confirms that the output voltage of the UUT is between the upper limit voltage threshold (V_{Hi}) and the lower limit voltage threshold (V_{Lo}).

UUT output in short test

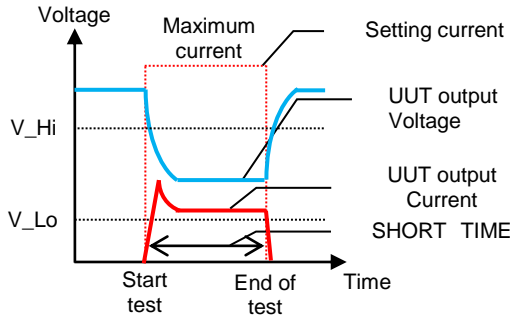

Description

When the test is started, the LSC series will try to carry the maximum current of the LSC series for the set test time (SHORT TIME) as indicated by the red dotted line.

During the test, UUT short circuit protection works, which causes the UUT output voltage to drop and the output current to be limited.

The setting method of the Short test is described below.

Short

Pressing the Short key sets the LSC series to the short test function. The LCD display changes each time the short key is pressed, and the short test time, the upper limit voltage threshold, and the lower limit voltage threshold can be set. Use the numeric keys, rotary knob, and arrow keys to set each setting.

When using the Short test with turbo mode ON, set it to "TURBO ON" by pressing the Conf key.

The order shown on the display and the corresponding settings are as follows:

State	LCD display	Description
1		Press the "Start/Stop t key" to start and end of the "Short test".
2		If the "Short test time" is set to "CONTI", this test time is set to continuous (infinite).
		If a time is set, this test will end at the set time. The unit is "ms".

3



Set the upper limit voltage threshold. The unit is "V".

4



Set the lower limit voltage threshold. The unit is "V".

6



Exit SHORT test set-up.



After setting the parameters, press the "Start/Stop key" while "SHORT PRESS START" is displayed on the LCD display to start the short test. Pressing the "Start/Stop key" during the short test terminates the short test.

During the test, the LCD display shows "run" and also shows the actual short circuit current.

Pressing the "Start/Stop key" during the short test terminates the short test.

Note

If the voltage level measured during the test stays within the V_{Hi} and V_{Lo} threshold levels, the message PASS is displayed, otherwise it will show "FAIL". Also, the current value measured after 10ms from the start of the test is displayed in the lower right of the LCD display.

If the voltage level measured during the test exceeds the V_{Hi} and V_{Lo} threshold levels, the message FAIL is displayed. The NG indicator also lights up.

For the setting specifications of each parameter, refer to the Short test items in "11-2. LSC series Specifications".

7-2. OCP test

In this test, the load current is gradually increased in order to verify the overcurrent protection operation of the UUT. This test confirms that the UUT's overcurrent protection operates above the lower voltage threshold (VTH). The test ends when the UUT output voltage reaches the VTH voltage.

UUT output in OCP test

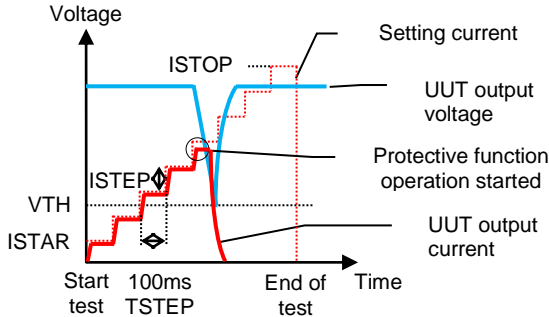

Description

When the test is started, the LSC series will try to flow current stepwise from the start current (ISTAR) to the end current (ISTOP) as indicated by the dotted red line. The current increase is performed every 100ms (TSTEP), and the current increases at the current value set in "ISTEP". In the turbo mode setting, TSTEP is 20ms.

When the test is started, the output current of the UUT begins to flow in a staircase pattern. When the UUT output current is near the black circle, the UUT overcurrent protection function starts operating. At this time, the UUT output voltage drops and the output current is limited.

The setting method of the OCP test is described below.



Pressing the OCP key sets the LSC series to the OCP test function. The LCD display changes each time the OCP key is pressed, and the test start current value, the increasing current value, the test end current value and the lower limit voltage threshold can be set. Use the numeric keys, rotary knob, and arrow keys to set each setting.

When using the OCP test with turbo mode ON, set it to "TURBO ON" by pressing the Conf key.

The order shown on the display and the corresponding settings are as follows:

State	LCD display	Description
1		Press the "Start/Stop t key" to start and end of the "OCP test".
2		Set the test start current value. The unit is "A".
3		Set the increasing current value. The unit is "A".
4		Set the test end current value. The unit is "A".
5		Set the lower limit voltage threshold. The unit is "V".
6		Exit OCP test set-up.



After setting the parameters, press the "Start/Stop key" while "OCP PRESS START" is displayed on the LCD display to start the OCP test.

During the test, the LCD display shows "run" and also shows the actual current.

Pressing the "Start/Stop key" during the OCP test terminates the OCP test.

Note

During the test, if the measured voltage is lower than the V_{Th} voltage or the measured current reaches the I STOP current, the test will stop and the LCD display will show "OCP ERROR".

During the test, if the UUT voltage remains above the V_{Th} voltage, the LCD display will show "PASS", otherwise it will show "FALL". Also, the current drawn from the UUT must be less than the I STOP setting for the test to pass.

If the UUT passes the test, the LCD display will show the maximum current measured during the test.

For the setting specifications of each parameter, refer to the OCP test items in "11-2. LSC series Specifications".

7-3. OPP test

In this test, the load power is gradually increased in order to verify the overpower protection operation of the UUT. This test confirms that the UUT's overpower protection operates above the lower voltage threshold (V_{Th}). The test ends when the UUT output voltage reaches the V_{Th} voltage.

UUT output in OPP test

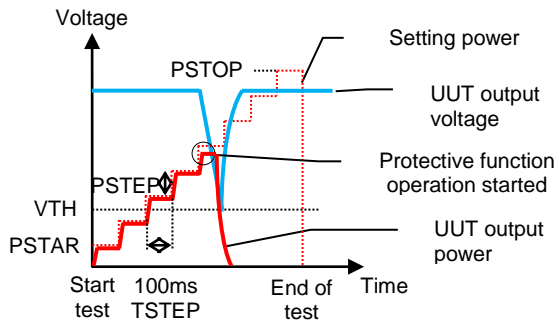

Description

When the test is started, the LSC series sets the power stepwise from the start power (PSTAR) to the end power (ISTOP) as shown by the red dotted line, and tries to pass the current with that power. The power increase is performed every 100ms (TSTEP), and the power increases at the power value set in "PSTEP". In the turbo mode setting, TSTEP is 20ms.

When the test is started, the output power of the UUT begins to flow in a staircase pattern. When the UUT output power is near the black circle, the UUT overpower protection function starts operating. At this time, the UUT output voltage drops and the output power is limited.

The setting method of the OPP test is described below.



Pressing the OPP key sets the LSC series to the OPP test function. The LCD display changes each time the OPP key is pressed, and the test start power value, increase power value, test end power value, and lower limit voltage threshold can be set. Use the numeric keys, rotary knob, and arrow keys to set each setting.

When using the OPP test with turbo mode ON, set it to "TURBO ON" by pressing the Conf key.

The order shown on the display and the corresponding settings are as follows:

State	LCD display	Description
1		Press the "Start/Stop t key" to start and end of the "OPP test".
2		Set the test start power value. The unit is "W".
3		Set the increasing power value. The unit is "W".
4		Set the test end power value. The unit is "A".
5		Set the lower limit voltage threshold. The unit is "V".
6		Exit OPP test set-up.



After setting the parameters, press the "Start/Stop key" while "OPP PRESS START" is displayed on the LCD display to start the OPP test.

During the test, the LCD display shows "run" and also shows the actual current.

Pressing the "Start/Stop key" during the OPP test terminates the OPP test.

Note

During the test, if the measured voltage is lower than the VTh voltage or the measured power reaches the P STOP power, the test will stop and the LCD display will show "OPP ERROR".

During the test, if the UUT voltage remains above the VTh voltage, the LCD display will show "PASS", otherwise it will show "FALL". Also, the power from the UUT must be less than the P STOP setting for the test to pass.

If the UUT passes the test, the LCD display will show the maximum

power measured during the test.

For the setting specifications of each parameter, refer to the OPP test items in “11-2. LSC series Specifications”.

7-4. BMS test

Lithium batteries are widely used in a variety of electronic products and devices such as electric vehicles. To protect the lithium battery from ignition, explosion, or other dangerous conditions, the lithium battery must be designed with a battery management system (BMS) protection circuit.

BMS ensures that the charging voltage does not exceed the maximum safe value (overvoltage protection or OVP) of the lithium battery during the charging cycle. Also, monitor the discharge to make sure the battery is short-circuited or exceeds the rated current (overcurrent protection or OCP). Finally, the internal battery and cell temperatures are monitored for overheating or under temperature protection (OTP / UTP).

The LSC series can evaluate the BMS protection circuit by two kinds of test methods (BMS Short, BMS OCP).

Overcharge
Current
Protection
(OCCP) connection example

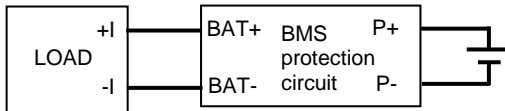

Over current
discharge
protection
(OCDP) connection example

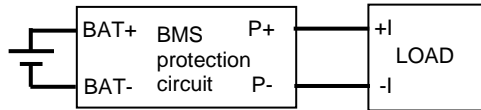

7-4-1. BMS Short test

In order to test the BMS (P+, P- terminal) short circuit protection operation, the LSC series operates so that the maximum load current flows.

BMS Short test
BMS protection
circuit current

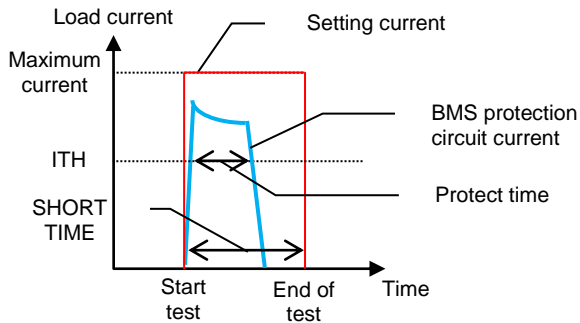

Description

Set SHORT TIME, ITH and start the test.
The LSC series is set to the maximum specified current and flows current. During the test, the display will read “SHORT TEST”.

At the end of the test, the peak current and protect time are displayed on the LCD.

The setting method of the BMS Short test is described below.

BMS



Short

Press the “BMS key” and then the “Short key” to set the LSC series to the BMS Short test function.

BMS Short test

The LCD display changes each time the short key is pressed, and the short test time, and the upper limit current threshold can be set.

Use the numeric keys, rotary knob, and arrow keys to set each setting.

The order shown on the display and the corresponding settings are as follows:

State	LCD display	Description
1		Press the “Start/Stop t key” to start and end of the “BMS Short test”.
2		Set the Short test time. The unit is "ms". The setting resolution is 0.01ms.
3		Set the upper limit current threshold. The unit is "A". The set resolution is 0.01A.
4		Exit BMS Short test set-up.

Start
Stop

After setting the parameters, press the “Start/Stop key” while “SHORT PRESS START” is displayed on the LCD display to start the BMS Short test.

Pressing the “Start/Stop key” during the BMS Short test terminates the BMS Short test.

Note

During the test, if the BMS protection circuit current does not reach the current value below ITH within SHORT TIME, “TIME OVER” will be displayed on the LCD display.

After the test is finished, the current value measured after 10ms from the start of the test and the protection time are displayed on the LCD display.

For the setting specifications of each parameter, refer to the BMS Short test items in “11-2. LSC series Specifications”.

7-4-2. BMS OCP test

In order to test BMS (BAT+, BAT- terminals) OCCP operation and BMS (P+, P- terminals) OCPD operation, the LSC series operates to flow current in a stepped manner. Measures overcurrent and protection time.

BMS OCP test
BMS protection
circuit current

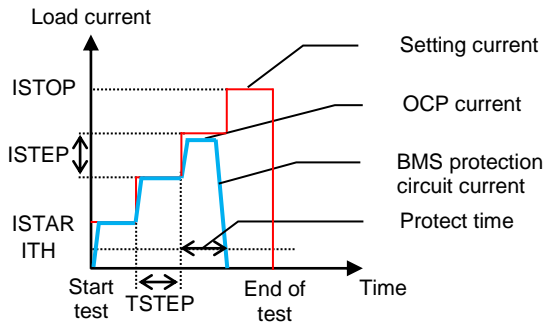

Description

Set ISTAR, TSTEP, ISTEP, ISTOP, ITH (0.01A~<ISTART) and start the test.

When the test starts, the LSC series will be in operation to flow current from ISTAR to ISTOP as indicated by the red line. Its current increase is set by TSTEP and ISTEP.

“OCP TEST” is displayed on the LCD until the BMS protection circuit operates (the current flowing through the load becomes smaller than ITH) or reaches ISTOP.

When the test is finished, the OCP current and Protect time will be displayed on the LCD.

The setting method of the BMS OCP test is described below.

BMS

⇒

OCP

Press the “BMS key” and then the “OCP key” to set the LSC series to the BMS OCP test function.

BMS
OCP test

The LCD display changes each time the OCP key is pressed, and the test starts current value, the increase time value, the increasing current value, the test end current value, and the upper limit current threshold can be set.

Use the numeric keys, rotary knob, and arrow keys to set each setting.

The order shown on the display and the corresponding settings are as follows:

State

LCD display

Description

1



Press the “Start/Stop t key” to start and end of the “BMS Short test”.

2



Sets the test start current value in the range 0.96 to 600.00. The unit is "A". The setting resolution is 0.01A.

3



Sets the increment time value in the range 0.05 to 1000. The unit is "ms". The setting resolution is 0.01ms.

4



Sets the increasing current value in the range 0.00 to 600.00. The unit is "A". The setting resolution is 0.01A.

5



Set the test end current value range from 0.96 to 600.00. The unit is "A". The setting resolution is 0.01A.

6



Set the upper limit current threshold in the range 0.29 to 300.00. The unit is "A". The setting resolution is 0.01A.

7



Exit BMS OCP test set-up.



After setting the parameters, press the "Start/Stop key" while "OCP PRESS START" is displayed on the LCD display to start the BMS OCP test.

Pressing the "Start/Stop key" during the BMS OCP test terminates the BMS OCP test.

7-5. Batt test

In this test, the battery discharge test is performed in CC mode or CP mode. In this test, four types of discharge stop conditions (voltage, time, current time, power time) can be set.

In this test, the total discharge capacity (AH and WH) of the battery discharge can be measured.

Discharge stop condition: Voltage

The test ends when the battery voltage drops to the discharge stop voltage (VOLT.V).

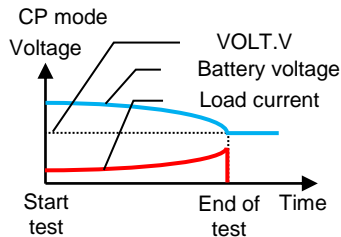
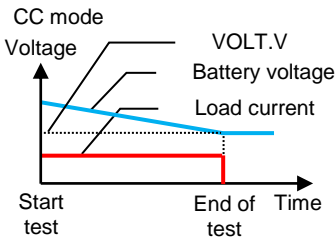

Discharge stop condition: time

The test ends when the test time reaches the discharge stop time (TIME.S).

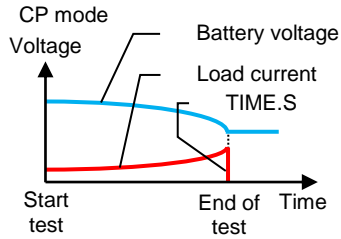
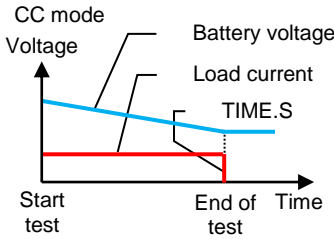

Discharge stop condition: Current time

The test ends when the battery discharge current time (CAP.AH) is reached.

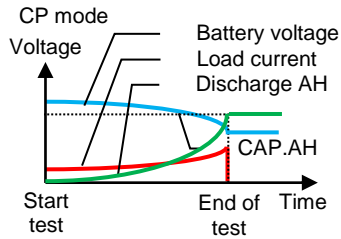
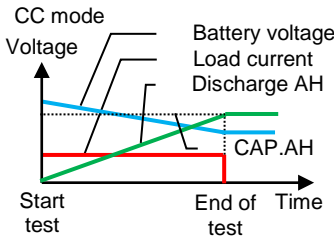

Discharge stop condition: Power time

The test ends when the battery discharge power time (CAP.WH) is reached.

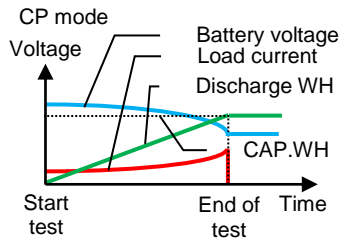
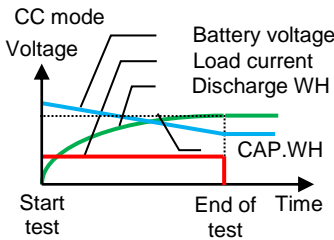







The setting method of the Batt test is described below.

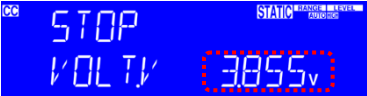

Press the "Batt key", the LSC series sets to the Batt test function. The LCD display changes each time the Batt key is pressed, and the current/power value in CC/CP mode, the discharge stop voltage, the discharge stop time, the discharge stops current time, and the discharge stops power time can be set. Use the numeric keys, rotary knob, and arrow keys to set each setting.

The order shown on the display and the corresponding settings are as follows:

State	LCD display	Description
-------	-------------	-------------

1		<p>Press the “Batt key” to set the LSC series to the “Batt test function”.</p> <p>Operate the Mode key to select the discharge mode. Press the “Start/Stop t key” to start and end of the “Batt test”.</p>
2		<p>Set the current value in CC mode. The unit is "A".</p> <p>Set the power value in CP mode. The unit is "W".</p>
3		<p>Set the discharge stop voltage. The unit is "V".</p>
4		<p>Set the discharge stop time. The unit is "seconds".</p>
5		<p>Set the discharge stop current time. The unit is "AH".</p>
6		<p>Set the discharge stop power time. The unit is "WH".</p>
7		<p>Exit Batt test set-up.</p>

Note The Batt test is finished and the LSC series LCD display shows the voltage value at the end of the test. In addition, three types of test execution time, total discharge capacity AH and WH are displayed alternately.

For the setting specifications of each parameter, refer to the Batt test items in “11-2. LSC series Specifications”.

7-6. Surge test





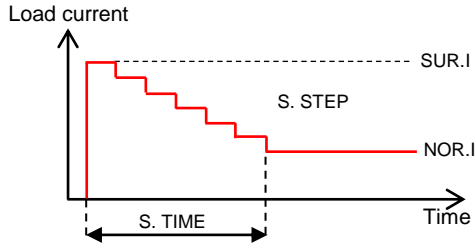

Description The “Surge test” is an operation in which a large load current flows when the LSC series LOAD is ON.

- Setting Parameter Set the following parameters.
- Surge current value (SUR.I) at LOAD ON
 - Current value (NOR.I) at the end of surge current
 - Time when surge current ends (S.TIME)
 - Number of surge current attenuation steps (S.STEP)

Test image



Operation method

State	Description
1	 <p>Operate the DYN Setting key to set SUR.I, NOR.I, S.TIME, and S.STEP. For the setting method, refer to "2-3-5. DYN Setting key".</p>
2 SUG. I	 <p>Set the surge current when LOAD is ON. The unit is "A".</p>
3 NOR.I	 <p>Set the current at the end of the surge current. The unit is "A".</p>
4 S. TIME	 <p>Set the time when the surge current ends. The unit is "ms".</p>
5 S. STEP	 <p>Sets the number of surge current attenuation steps.</p>
6	 <p>In the above state 2-5, press the Start/Stop key to start the surge test. Pressing the Start/Stop key during the surge test terminates the surge test.</p>

7-7. SEQUENCE LOAD

Description The SEQUENCE LOAD test is for REMOTE operation only. The SEQUENCE LOAD test needs to set the number of steps from 2 to 16, and set the load value and time for each step. After the test starts, it will be repeated according to the

set value until the voltage is less than the VTH value. Or receive a Stop command to stop the test.
 The TRIG command can be used to change the discharge mode and load value while the test is running.

Setting Parameter

Test discharge mode: CC or CP
 Step number: n=0~15
 Load setting for each step: CCn or CPn
 Each step time range (Tn): 0.020~999.000ms
 Range 0: 0.02~1.00ms, resolution: 0.01ms, n=1~15
 Range 1: 2~65535ms, resolution: 1ms, n=0~15
 Range 2: 66000~999000ms, resolution: 1000ms, n=0~15

Test image

In the case of 4 steps

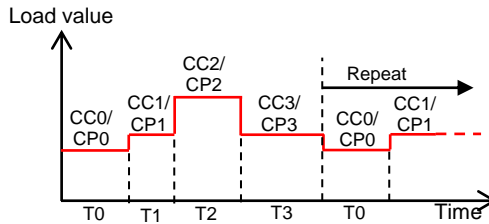

SEQUENCE LOAD TEST command

Sequence Load test set command	Note
SEQLD:TYPE{SP}{CC CP}{; NL}	SET CC or CP MODE
SEQLD:TOTSTEP{SP}{n}{; NL}	SET STEP, n=2~16
SEQLD:TIME{n}{SP}{NR1}{; NL}	SET ΔTIME= 0.02~999000ms, n = 0~15
SEQLD:CC{n}{SP}{NR2}{; NL}	SET CURRENT, UNIT: A, n = 0~15
SEQLD:CP{n}{SP}{NR2}{; NL}	SET POWER, UNIT: W, n = 0~15
SEQLD:TRIG{SP}{ON}{; NL}	TRIGGER CHANGE CC/CP VALUE
SEQLD:TEST{SP}{ON OFF}{; NL}	SET START or STOP TEST

8. Description of AUTO Sequence function

The LSC series can be operated with the “AUTO Sequence function”.

This “AUTO Sequence function” saves up to 9 types of “Automatic tests” and runs one of them.

One Automatic test can be repeated up to 10,000 times.

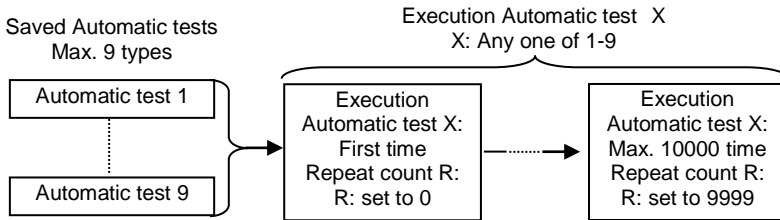

Each “Automatic tests” can have up to 16 steps each.

For each step, set one of the 150 types of various setting states saved in the LSC series.

Set the execution time of each step in the range of 0.1s - 9.9s (100ms resolution).

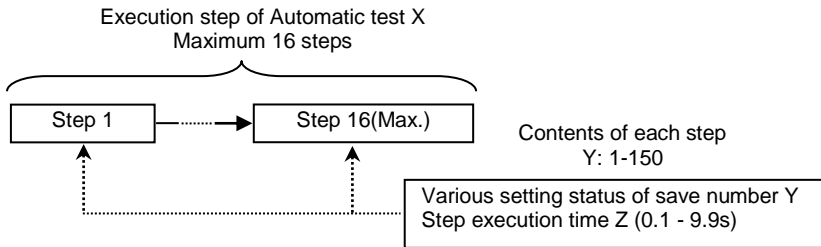

The various setting states of the save number Y are the various setting states (up to 150 types) saved by the “Store key”.

8-1. Editing the AUTO sequence function

When setting the automatic test of this function for the first time, perform the following operations 1 - 8.

Before performing the following operations 1 - 8, it is necessary to set various setting states (Max. 150 types) to be selected in the step.

1. Start of AUTO sequence function



When the “SEQ key” is pressed, the LSC series will be in the state when the “AUTO sequence function” can be operated.

Press the “Exit key” to exit the “AUTO sequence function”.

2. Select edit



Operate the arrow keys so that EDIT (green dotted line in the figure below) is displayed on the left display side.

3. Select the Automatic test number



Select the "Automatic test" number (red dotted line in the above figure) to edit in the range F1 - F9. Use the number keys to select.

4. Select the step execution content

Enter



The green dotted line in the above figure shows the "Automatic test" number (F1) and step number (01).

To select the step execution content, select the save number (red dotted line in the above figure) of various settings states in the range 1-150. Use the number keys to select.

5. Set the time for step execution

Enter



Set the execution time (red dotted line in the above figure) of F01-01 (step 1 of Automatic test 1) from 100 - 9999. The unit is "ms".

6. Select next step

Enter

Press the "Enter key", select the execution content of the next step.

Note

If do not select the execution content of the next step, do not press to the "Enter key". Perform operation 7.



The step number is the previous step +1. In the above figure (green dotted line part), it is 02 (= 01 + 1).

Perform step 4 and 5 to select the execution content of this step number and set the execution time.

7. Repeat count setting

Save

Press the "Save key", set the repeat count of "Automatic Test X".

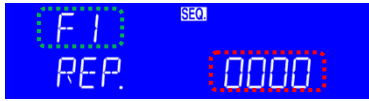

F1 (green dotted line in the above figure) shows the “Automatic test” number. In the figure above, automated test 1 is displayed.

Set the repeat count of “Automatic test X” (red dotted line in the above figure) in the range 0 - 9999. Use the arrow keys or the number keys to make settings.

Note If the repeat count is 0, the “Automatic test” will be executed once.

8. End of editing

Enter

Press the “Enter key” to save the number of executions of “Automatic test X” and finish editing the “AUTO Sequence function”.

Exit

Press the “Exit key” to exit editing the “AUTO Sequence function” without saving the number of executions of “Automatic test X”.

8-2. Executing Automatic test

1. Start of AUTO sequence function



When the “SEQ key” is pressed, the LSC series will be in the state when the “AUTO sequence function” can be operated.

Press the “Exit key” to exit the “AUTO sequence function”.

2. Select execution

△ or ▽

Operate the arrow keys so that “TEST” is displayed on the left display side (green dotted line in the figure below).

3. Select Automatic test number



Select the “Automatic test” number (red dotted line in the above figure) to be executed in the range 1 - 9. Use the number keys to select.

4. Executing Automatic test

Enter

Press the “Enter key”, executing the selected “Automatic test”.

Note

Pressing the “Enter key” while the “Automatic test” is finished or interrupted, the “Automatic test” will be rerun or restarted.

5. Interruption of Automatic test

Exit

The executing “Automatic test” is interrupted by pressing the “Exit key”.

Note Pressing the “Exit key” while the “Automatic test” is interrupted exits the “AUTO sequence function”.



There are no remote commands to interrupt the “Automatic test”. To interrupt the “Automatic test” during remote operation Press the Local key to bring the LSC series to the local state, then press the Exit key.

Description of the “Automatic test” execution

During Automatic test execution	The LCD display shows the step number being performed.
When NG occurs during “Automatic test” execution.	The LCD display will show NG flashing and the “Automatic test” will be interrupted. A suspended “Automatic test” can be continued by pressing the “Enter key”.
When the “Automatic test” is completed without NG.	The LCD display shows “PASS”. The buzzer sounds once at the end of the “Automatic test”.
When NG occurs and the “Automatic test” ends.	The LCD display shows “FAIL”. If the buzzer is set to ON, the buzzer will sound twice at the end of the “Automatic test”.

8-3. AUTO Sequence setting example

When setting the automatic test of the AUTO Sequence function, first make various settings for various setting status numbers. Then set up an automatic test. This section describes how to set up an “Automatic test” such as:

Example Repeat steps 1-8 “Automatic test” twice to turn off the load.

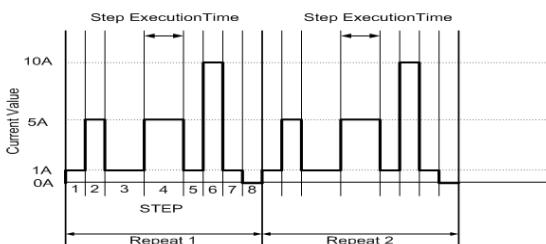

When setting various settings status numbers and automatic tests, do not input voltage to the DC input terminal of this unit.

8-3-1. Settings of various setting states

The table below shows the settings of various setting status numbers used in the automatic test of the AUTO Sequence function. Other settings are assumed to be set to the default values of the LSC series.

Various setting status numbers	Discharge mode	RANGE setting	Set current value	Load On/Off
1	CC	RANGE II	1A	On
2	CC	RANGE II	5A	On
3	CC	RANGE II	10A	On
4	CC	RANGE II	0A	On

Setting method

- 1 Set the LSC series to the following.
Discharge mode: CC, RANGE: RANGE II, Current setting: 1A, Load On
- 2 Press the “Store key” and set the save destination number for each setting to 1. Then press “Enter key”. By these operations, various setting states of the LSC series were saved in various setting status numbers 1.
- 3 Set various setting states of the LSC series as in step 1, and save the various setting states in various setting status numbers 2-8 as in step 2.

8-3-2. Set up Automatic test

The contents of the “Automatic test” to be set are shown in the table below. In addition, the “Automatic test” number is “3”, and the number of times the “Automatic test” is repeated count is one (the “Automatic test” is executed twice).

Step number	Step execution content	Step execution time
1	Various setting status number 1 (CC1A, Load On)	200ms
2	Various setting status number 2 (CC5A, Load On)	200ms
3	Various setting status number 1 (CC1A, Load On)	400ms
4	Various setting status number 2 (CC5A, Load On)	400ms
5	Various setting status number 1 (CC1A, Load On)	200ms
6	Various setting status number 3 (CC10A, Load On)	200ms
7	Various setting status number 1 (CC1A, Load On)	200ms
8	Various setting status number 4 (CC0A, Load On)	200ms

Setting method

- 1 
- 2 
- 3 

Press the “SEQ key” and operate the arrow keys so that “EDIT” is displayed on the left display side.

Set the “Automatic test” number to “F3”. After setting the “Automatic test” number, press “Enter key”.

The “Automatic test” number and step number are displayed (green dotted line). Set STATE to “1”. After setting the STATE, press the “Enter key”.

4



Set the step execution time to 200ms. After setting the step execution time, press the “Enter key”.

5

As in steps 2 and 3, set the step execution content (various setting status numbers X) and step execution time in step numbers 2-8.

6

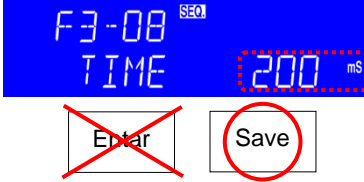

After setting the execution time for the last step number 8 of “Automatic test 3”, press the “Save key”.

Press the “Enter key” to set the next step number.

7



Set the number of repeat count of automated test 3 to 1.

After setting the number of repeat count, press the “Enter key” to finish the setting of “Automatic test 3”.

9. Remote control

9-1. Interface configuration

The LSC series can be operated from a PC using the optional communication interface.

Use the communication interface to set the load status of the LSC series and read back the load status (voltage, current, power) of the LSC series.

This feature can be used as an automatic load / mutual load adjustment and centering voltage test for the power supply, or as a charge / discharge characteristic test for a rechargeable battery.

Note When controlling the LSC series using a USB or LAN interface, the LSC series converts the USB / LAN interface to an RS-232C interface.

9-1-1. RS-232C configuration

The following RS-232C commands are the same as the GP-IB commands. The RS-232C protocol of the LSC series is as follows.

RS-232C configuration	Baud rate	9600~115200bps
		Operate the System key and set with the RS-232C item.
	Stop bit	1bit
	Data bit	8bit
	Parity	none
	Handshake	Hardware (RTS/CTS)
	Connector	D-sub 9 pin female DCE connector

RS232C port connection

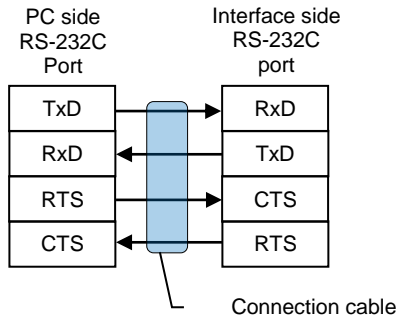

When connecting a PC, use a cable with RS-232C straight connection and D-sub9 male-D-sub9 female connection. This cable is sold as an extension cable.

Interface pin assignment

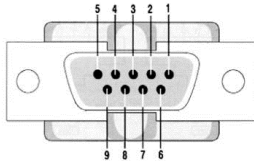

Pin No.	Abbreviation	Description
1	CD	Carrier Detect
2	RXD	Receive
3	TXD	Transmit
4	DTR	Data Terminal Ready
5	GND	Ground
6	DSR	Data Set Ready
7	RTS	Request To Send
8	CTS	Clear To Send
9	RI	Ring Indicator

9-1-2. GP-IB configuration

GP-IB commands are SCPI compliant. The LSC series GP-IB specifications are as follows.

GP-IB configuration standard IEEE488-1978 compliant
 Address range 1-30
 Operate the System key and set in the "GP-IB item".

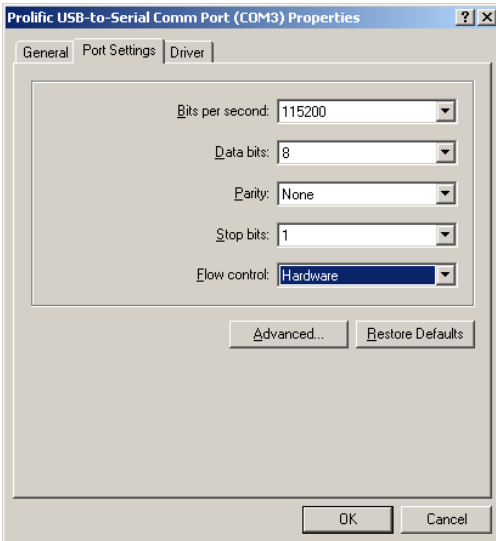
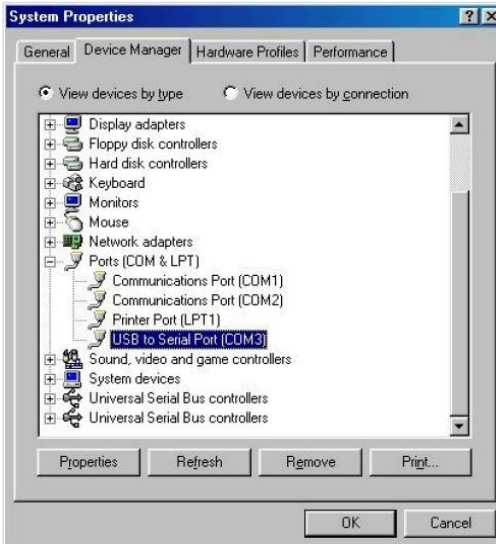

9-1-4. LAN configuration

LAN commands are SCPI compliant. The LSC series LAN specifications are as follows.

LAN configuration	standard	100Base-TX, IPv4 Socket communication, HTTP communication (Communication settings only)
-------------------	----------	--

For LAN settings, use a dedicated application to search for devices and use a browser to update the settings. The operation procedure is described below.

1. Connecting AC power and the network line to the LSC series mainframe, connect the other Side of the network line to the HUB.

For Windows:

Run the IPScanner.EXE (This file can be downloaded from our website), If a Windows security alert appears, please select a public network, and then click “Allow Access”, the following screen will appear. if not, please press F5 to search again, or check the first step was succeed or not.

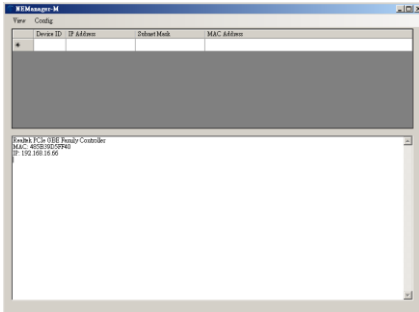

2. The installations searched for on the screen are displayed. Click on it and select Set IP Address. Set the IP address and Subnet mask.



3. It will be shown the Setup Device as the following figure if all steps were corrected to be run.

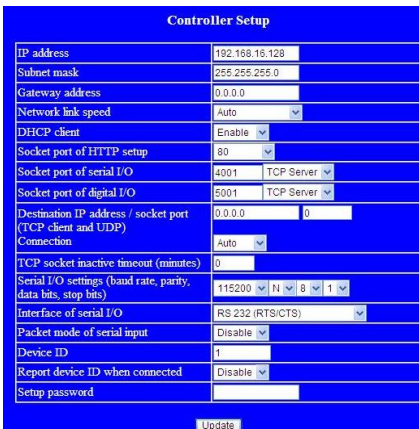

- 4 Insert the numbers as the following:
- IP Address: as recommended according to your network.
 - A. Subnet Mask: as recommended according to your network.
 - B. Gateway Address: as recommended according to your network.
 - C. Network link speed: Auto
 - D. DHCP client: Enable
 - E. Socket port of HTTP setup: 80
 - F. Socket port of serial I/O: 4001, TCP Server
 - G. Socket port of digital I/O: 5001, TCP Server
 - H. Destination IP address/ socket port (TCP client and UDP) Connection:
Auto
 - I. TCP socket inactive timeout (minutes): Set the network disconnection after N minutes, set 0 minutes will work forever.
 - J. Serial I/O settings (baud rate, parity, data, bits, stop bits): 115200, N, 8, 1
 - K. Interface of serial I/O: RS 232 (RTS/CTS)
 - L. Packet mode of serial input: Disable
 - M. Device ID: 5
 - N. Report device ID when connected: Auto
 - O. Setup password: Not required

9-2. Command syntax

9-2-1. The description of abbreviation

Command	SP	Space, the ASCII code is 20 Hexadecimal.
Tree	:	Semicolon, Program line terminator, the ASCII code is 3B (Hexadecimal).
	NL (IF)	New line, Program line terminator, the ASCII code is 0A (Hexadecimal).
	NR1	Integer
	NR2	Digit with a decimal point. It can be accepted in the range and format of "###. #####". For Example::30.12345, 5.0

9-2-2. Communication Interface programming command syntax description

Syntax Description: A description of the GPIB programming command syntax.

{ } The contents of the { } symbol must be used as a part or data of the GPIB command, it cannot be omitted.

[] The contents of the [] symbol indicates the command can be used or not. It depends on the testing application.

| This symbol means option. For example, LOW HIGH means it can only use LOW or HIGH as the command, it can choose only one as the setting command.

Terminator After sending the GPIB command, you need to send the program line terminator character. The following table shows the command terminator characters that can be used with the LSC series.

LF
LF with EOI
CR, LF
CR, LF with EOI

;

The semicolon ";" is a backup command. Semicolons allow you to combine command statements on a single line to compose a command message.

9-3. Remote commands

The LSC series does not support IEEE488.2 common commands (*IDN?,*RST,*CLS command).

9-3-1. Preset commands

Preset commands are used to read the settings and settings of the LSC series.

Command name	Brief description	Page
RISE	Rise of slew rate	75
FALL	Fall of slew rate	75
PERI:HIGH	Dynamic mode Thigh time	76
PERD:LOW	Dynamic mode Tlow time	76
LDONv	LOAD on voltage	76
LDOFv	LOAD off voltage	77
CURR:{HIGH LOW}	CC mode current value	77
CP:{HIGH LOW}	CP mode power value	77
{CR RES}:{HIGH LOW}	CR mode resistance value	78
CV:{HIGH LOW}	CV mode voltage value	78
TCONFIG	Select the test function	78
OCP:START	OCP test start current value	79
OCP:STEP	OCP test increased current value	79
OCP:STOP	OCP test end current value	79
OCP?	OCP test current value readback	79
VTH	OCP, OPP test Vth value	80
OPP:START	OPP test start power value	80
OPP:STEP	OPP test increased power value	80
OPP:STOP	OPP test end power value	80
OPP?	OPP test power value readback	81
STIME	Short test time	81
BATT:CC	Batt test current value	81
BATT:CP	Batt test power value	81
BATT:UVP	Batt test stop voltage value	81
BATT:TIME	Batt test stop time	82
BATT:AH	Batt test stop AH value	82
BATT:WH	Batt test stop WH value	82
BATT:TEST	Select Batt test on / off	82
BATT:RTIME?	Batt test results time readback	82
BATT:RAH?	Batt test result current time readback	83
BATT:RWH?	Batt test result power time readback	83
BATT:RVOLT?	Batt test result voltage readback	83
SURGE:SURI	Surge test Surge current	83
SURGE:NORI	Surge test normal current	83

SURGE:TIME	Surge test Surge time	84
SURGE:STEP	Number of surge test steps	84
SURGE {ON OFF}	Select Surge test on / off	84
BMS	Select BMS test enable / disable	84
BMS:STIME	BMS Short test time	84
SHORT:ITH	BMS Short test lth value	84
OCP:ITH	BMS OCP test lth value	85
OCP:TSTEP	BMS OCP test current increase time	85
AVG	V / A / W display value average time	85
TURBO	Select TURBO mode on / off	85
EXT:AIN	Select Analog voltage terminal on / off	85
SEQLD:TYPE	SEQ LOAD test: Set CC/CP mode	86
SEQLD:TOTSTEP	SEQ LOAD test: Set total STEP	86
SEQLD:TIME	SEQ LOAD test: Set STEP time	86
SEQLD:CC	SEQ LOAD test: Set CC value	86
SEQLD:CP	SEQ LOAD test: Set CP value	87
SEQLD:TRIG	SEQ LOAD test: Discharge mode and load value change	87
SEQLD:TEST	SEQ LOAD test: Start/Stop	87

Set →
→ Query

RISE

Description Set up and read RISE.

The RISE definition can be a large load level change or a "Rise slew rate" for dynamic behavior. It is completely independent of FALL.

If the set RISE value exceeds the LSC series specifications, it will be set to the maximum or minimum value of the model. The unit is "A / us".

Syntax [PRESet:]RISE{SP}{NR2}{;|NL}

Query Syntax [PRESet:]RISE?{;|NL}

Response NR2

Set →
→ Query

FALL

Description Set up and read FALL.

The FALL definition can be a large load level change or a "Fall slew rate" for dynamic behavior. It is completely independent of RISE.

If the set FALL value exceeds the LSC series specifications, it will be set to the maximum or minimum value of the model. The unit is "A / us".

Syntax	[PRESet:]FALL{SP}{NR2}{; NL}
Query Syntax	[PRESet:]FALL?{; NL}
Response	NR2

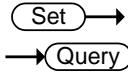

PERI:HIGH

Description	Set and read Thigh for DYNAMIC mode. If the set value exceeds the LSC series specifications, it will be set to the maximum or minimum value of the model. The unit is "ms".
-------------	--

Syntax	[PRESet:]PERI:HIGH{SP}{NR2}{; NL}
Query Syntax	[PRESet:]PERI:HIGH?{; NL}
Response	NR2

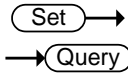

PERD:LOW

Description	Set and read Tlow for DYNAMIC mode. If the set value exceeds the LSC series specifications, it will be set to the maximum or minimum value of the model. The unit is "ms".
-------------	---

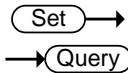

Syntax	[PRESet:]PERD:LOW{SP}{NR2}{; NL}
Query Syntax	[PRESet:]PERD:LOW?{; NL}
Response	NR2





LDONv

Description	Set and read the LOAD ON voltage. This command sets and reads LDON items for Config key operations. The unit is "V".
-------------	--

Syntax	[PRESet:]LDONv{SP}{NR2}{; NL}
Query Syntax	[PRESet:]LDON?{; NL}
Response	NR2

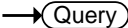
		 
<hr/>		
LDOFv		
Description	Set and read the LOAD OFF voltage. This command sets and reads the LDoff item for Config key operations. The unit is "V".	
Syntax	[PRESet:]LDOFv{SP}{NR2}{; NL}	
Query Syntax	[PRESet:]LDOFv?{; NL}	
Response	NR2	

		 
<hr/>		
CURR:{HIGH LOW}		
Description	<p>Set and read HIGH and LOW load currents in CC mode. HIGH and LOW load current values are the high load level and low load level load current values in CC mode.</p> <p>If the set value exceeds the LSC series specifications, it will be set to the maximum or minimum value of the model. The unit is "A".</p> <p>Set the LOW load current value to be smaller than the HIGH load current value.</p>	
Syntax	[PRESet:]CURR:{HIGH LOW}{SP}{NR2}{; NL}	
Query Syntax	[PRESet:]CURR:{HIGH LOW}?{; NL}	
Response	NR2	

		 
<hr/>		
CP:{HIGH LOW}		
Description	<p>Set and read HIGH and LOW load power in CP mode. HIGH and LOW load power values are the high load level and low load level load power values in CP mode.</p> <p>If the set value exceeds the LSC series specifications, it will be set to the maximum or minimum value of the model. The unit is "W".</p> <p>Set the LOW load power value to be smaller than the HIGH load power value.</p>	
Syntax	[PRESet:]CP:{HIGH LOW}{SP}{NR2}{; NL}	
Query Syntax	[PRESet:]CP:{HIGH LOW}?{; NL}	
Response	NR2	

Set →

→ Query

{CR|RES}:{HIGH|LOW}

Description Set and read HIGH and LOW load resistance in CR mode. HIGH and LOW load resistance values are the load resistance values of High load level and Low load level in CR mode.

The minimum setting digit for HIGH and LOW load power values is the third decimal place.

If the set value exceeds the LSC series specifications, it will be set to the maximum or minimum value of the model. The unit is "Ω".

Syntax [PRESet:]{CR|RES}:{HIGH|LOW}{SP}{NR2}{:|NL}

Query Syntax [PRESet:]{CR|RES}:{HIGH|LOW}?{:|NL}

Response NR2

Set →

→ Query

CV:{HIGH|LOW}

Description Set and read HIGH and LOW voltages in CV mode. The HIGH and LOW voltage values are the high load level and low load level voltage values in CV mode.

If the set value exceeds the LSC series specifications, it will be set to the maximum or minimum value of the model. The unit is "V".

The LOW voltage value should be smaller than the HIGH voltage value.

Syntax [PRESet:]CV:{HIGH|LOW}{SP}{NR2}{:|NL}

Query Syntax [PRESet:]CV:{HIGH|LOW}?{:|NL}

Response NR2

Set →

→ Query

TCONFIG

Description Enable the TEST function of the LSC series and read the enabled TEST function.

The TEST functions that can be set with this command are OCP test, OPP test, and SHORT test. When NORMAL is selected, the LSC series disables the TEST function and operates in each discharge mode.

To enable the BMS SHORT/OCP TEST function, enable the BMS TEST function with the BSM command, and then enable the TEST function with this command.

Syntax [PRESet:]TCONFIG{SP}{NORMAL|OCP|OPP|SHORT}{:|NL}

Query Syntax	[PRESet:]TCONFIG?{; NL}
Response	NR1 (1: NORMAL, 2: OCP, 3: OPP, 4: SHORT)

Set →

→ Query

OCP:START

Description Set and read the starting current value (ISTART) of the OCP test and BMS OCP test.
The unit is "A".

Syntax [PRESet:]OCP:START{SP}{NR2}{;|NL}

Query Syntax [PRESet:]OCP:START?{;|NL}

Response NR2

Set →

→ Query

OCP:STEP

Description Set and read the increased current value (ISTEP) of the OCP test and BMS OCP test.
The unit is "A".

Syntax [PRESet:]OCP:STEP{SP}{NR2}{;|NL}

Query Syntax [PRESet:]OCP:STEP?{;|NL}

Response NR2

Set →

→ Query

OCP:STOP

Description Set and read the end current value (ISTOP) of the OCP test and BMS OCP test.
The unit is "A".

Syntax [PRESet:]OCP:STOP{SP}{NR2}{;|NL}

Query Syntax [PRESet:]OCP:STOP?{;|NL}

Response NR2

→ Query

OCP?

Description Read the current of the OCP test. The unit is "A".

Query Syntax OCP?{;|NL}

Response NR2

		Set →
		→ Query
<hr/>		
VTH		
Description	<p>Sets and reads the lower voltage threshold (VTh) for OCP/OPP tests and SEQUENCE LOAD tests.</p> <p>The unit is "V".</p>	
Syntax	[PRESet:]VTH{SP}{NR2}{; NL}	
Query Syntax	[PRESet:]VTH?{; NL}	
Response	NR2	
<hr/>		
		Set →
		→ Query
<hr/>		
OPP:START		
Description	<p>Set and read the start power value (PSTART) of the OPP test.</p> <p>The unit is "W".</p>	
Syntax	[PRESet:]OPP:START{SP}{NR2}{; NL}	
Query Syntax	[PRESet:]OPP:START?{; NL}	
Response	NR2	
<hr/>		
		Set →
		→ Query
<hr/>		
OPP:STEP		
Description	<p>Set and read the Increased Power Value (PSTEP) for the OPP test.</p> <p>The unit is "W".</p>	
Syntax	[PRESet:]OPP:STEP{SP}{NR2}{; NL}	
Query Syntax	[PRESet:]OPP:STEP?{; NL}	
Response	NR2	
<hr/>		
		Set →
		→ Query
<hr/>		
OPP:STOP		
Description	<p>Set and read the end current value (PSTOP) of the OPP test.</p> <p>The unit is "W".</p>	
Syntax	[PRESet:]OPP:STOP{SP}{NR2}{; NL}	
Query Syntax	[PRESet:]OPP:STOP?{; NL}	
Response	NR2	

OPP?

→ Query

Description	Read the power of the OPP test. The unit is "W".
Query Syntax	OPP?{; NL}
Response	NR2

STIME

Set →

→ Query

Description	Set and read the test time (TIME) of the SHORT test. Setting the time to 0 removes the time limit and makes it infinite. The setting range is 100-10000 and the unit is "ms".
Syntax	[PRESet:]STIME{SP}{NR2}{; NL}
Query Syntax	[PRESet:]STIME?{; NL}
Response	NR1

BATT:CC

Set →

→ Query

Description	Set and read the current for the Batt test. The unit is "A".
Syntax	[PRESet:]BATT:CC{SP}{NR2}{; NL}
Query Syntax	[PRESet:]BATT:CC?{; NL}
Response	NR2

BATT:CP

Set →

→ Query

Description	Set and read the power for the Batt test. The unit is "W".
Syntax	[PRESet:]BATT:CP{SP}{NR2}{; NL}
Query Syntax	[PRESet:]BATT:CP?{; NL}
Response	NR2

BATT:UVP

Set →

Description	Set the discharge stop voltage (VOLT.V) of the Batt test. The unit is "V".
Syntax	[PRESet:]BATT:UVP{SP}{NR2}{; NL}

BATT:TIME		Set →
Description	Set the discharge stop time (TIME.S) of the Batt test. The setting range is 0, 1-99999, and the unit is "s". When set to 0, it will be OFF.	
Syntax	[PRESet:]BATT:TIME{SP}{NR1}{; NL}	
		Set →
BATT:AH		→ Query
Description	Set and read the discharge stop current time (CAP.AH) for the Batt test. The setting range is 0, 0.1-19999.9, and the unit is "AH". When set to 0, it is OFF.	
Syntax	[PRESet:]BATT:AH{SP}{NR2}{; NL}	
Query Syntax	[PRESet:]BATT:AH?{; NL}	
Response	NR2	
		Set →
BATT:WH		→ Query
Description	Set and read the discharge stop power time (CAP.WH) for the Batt test. The setting range is 0, 0.1-19999.9, and the unit is "AW". When set to 0, it is OFF.	
Syntax	[PRESet:]BATT:WH{SP}{NR2}{; NL}	
Query Syntax	[PRESet:]BATT:WH?{; NL}	
Response	NR2	
		Set →
BATT:TEST		Set →
Description	Set the start and stop of the Batt test. ON: Start the Batt test, OFF: Stop the Batt test	
Syntax	[PRESet:]BATT:TEST{SP}{ON/OFF}{; NL}	
		→ Query
BATT:RTIME?		→ Query
Description	Read the time as a result of the Batt test. The unit of result time is "s".	
Query Syntax	[PRESet:]BATT:RTIME?{; NL}	
Response	NR1	

BATT:RAH?

→ Query

Description Read the current time as a result of the Batt test. The unit of result current time is "AH".

Query Syntax [PRESet:]BATT:RAH?{;|NL}

Response NR1

BATT:RWH?

→ Query

Description Read the power time as a result of the Batt test. The unit of result time is "WH".

Query Syntax [PRESet:]BATT:RWH?{;|NL}

Response NR1

BATT:RVOLT?

→ Query

Description Read the voltage as a result of the Batt test. The unit of result time is "V".

Query Syntax [PRESet:]BATT:RVOLT?{;|NL}

Response NR2

SURGE:SURI

Set →

→ Query

Description Set and read the surge current value (SUG. I) when LOAD is ON. The unit is "A".

Syntax [PRESet:]SURGE:SURI{SP}{NR2}{;|NL}

Query Syntax [PRESet:]SURGE:SURI?{;|NL}

Response NR2

SURGE:NORI

Set →

→ Query

Description Set and read the current value (NOR.I) at the end of the surge current. The unit is "A".

Syntax [PRESet:]SURGE:NORI{SP}{NR2}{;|NL}

Query Syntax [PRESet:]SURGE:NORI?{;|NL}

Response NR2

Set →

SURGE:TIME

→ Query

Description	Set and read the time (S. TIME) at which the surge current ends. Setting range: 10-1000, the unit is "ms".
Syntax	[PRESet:]SURGE:TIME{SP}{NR2}{; NL}
Query Syntax	[PRESet:]SURGE:TIME?{; NL}
Response	NR1

Set →

SURGE:STEP

→ Query

Description	Set and read the number of surge current attenuation steps (S. STEP). Setting range: 1-5
Syntax	[PRESet:]SURGE:STEP{SP}{NR1}{; NL}
Query Syntax	[PRESet:]SURGE:STEP?
Response	NR1

Set →

SURGE

Description	Set ON (RUN) / OFF (STOP) of the surge test.
Syntax	[PRESet:]SURGE{SP}{ON OFF}{; NL}

Set →

BMS

Description	Set BMS test ON 1 (able) / OFF 0 (disable).
Syntax	[PRESet:]BMS{SP}{ON OFF 1 0}{; NL}

Set →

BMS:STIME

Description	Set the BMS Short time. Range: 0.05-10.000, in "ms".
Syntax	[PRESet:]BMS:STIME{SP}{NR2}{; NL}

Set →

SHORT:ITH

Description	Set Ith of BMS Short test. The unit is "A".
Syntax	[PRESet:]SHORT:ITH{SP}{NR2}{; NL}

OCP:ITH		Set →
Description	Set lth of BMS OCP test. The unit is "A".	
Syntax	[PRESet:]OCP:ITH{SP}{NR2}{; NL}	
OCP:TSTEP		Set →
Description	Set the test increase time value of BMS OCP test. Range: 0.05-1000, in "ms".	
Syntax	[PRESet:]OCP:TSTEP{SP}{NR2}{; NL}	
AVG		Set → → Query
Description	Set and read the average time for reading voltage / current / power values. Range: 1-64.	
Syntax	[PRESet:]AVG{SP}{NR1}{; NL}	
Query Syntax	[PRESet:]AVG?{; NL}	
Response	NR1	
TURBO		Set → → Query
Description	Set and read turbo mode ON/OFF.	
Syntax	[PRESet:]TURBO{SP}{ON OFF}{; NL}	
Query Syntax	[PRESet:]TURBO?{; NL}	
Response	NR1 (ON:1, OFF:0)	
EXT:AIN		Set → → Query
Description	Set and read ON / OFF of the analog voltage input terminal.	
Syntax	[PRESet:]EXT:AIN{SP}{ON OFF}{; NL}	
Query Syntax	[PRESet:] EXT:AIN?{; NL}	
Response	NR1 (ON:1, OFF:0)	

Set →
→ Query

SEQLD:TYPE

Description	Sets and reads the SEQUENCE LOAD test discharge mode (CC/CP).
Syntax	SEQLD:TYPE{SP}{CC CP}{; NL}
Query Syntax	SEQLD:TYPE?{; NL}
Response	0(CC), 1(CP)

Set →
→ Query

SEQLD:TOTSTEP

Description	Sets and reads the total number of steps for the SEQUENCE LOAD test. Number of steps: n=2~16
Syntax	SEQLD:TOTSTEP{SP}{n}{; NL}
Query Syntax	SEQLD:TOTSTEP?{; NL}
Response	NR1

Set →
→ Query

SEQLD:TIME

Description	Sets and reads each step time for the SEQUENCE LOAD test. The unit is “ms”. Each step time can be changed during test execution. Step number: n=0~15. Step time range: 0.020~999.000ms Range 0: 0.02~1.00ms, resolution: 0.01ms, n=1~15 Range 1: 2~65535ms, resolution: 1ms, n=0~15 Range2: 66000~999000ms, resolution: 1000ms, n=0~15
Syntax	SEQLD:TIME{n}{SP}{NR2}{; NL}
Query Syntax	SEQLD:TIME{n}?{; NL}
Response	NR2

Set →
→ Query

SEQLD:CC

Description	Sets and reads the CC mode set current value for SEQUENCE LOAD test step number n. The unit is A.
Syntax	SEQLD:CC{n}{SP}{NR2}{; NL}
Query Syntax	SEQLD:CC{n}?{; NL}

Response	NR2
----------	-----

Set →

SEQLD:CP

→ Query

Description	Sets and reads the CP mode set current value for SEQUENCE LOAD test step number n. The unit is W.
Syntax	SEQLD:CP{n}{SP}{NR2}{; NL}
Query Syntax	SEQLD:CP{n}?{; NL}
Response	NR2

SEQLD:TRIG

Set →

Description	If this command is executed after resetting the discharge mode and load value with the “SEQLD:TYPE” and “SEQLD:CC/CP” commands, the discharge mode and load value will be changed during the SEQUENCE LOAD test.
Syntax	SEQLD:TRIG{SP}{ON}{; NL}

Set →

SEQLD:TEST

→ Query

Description	Set the execution (ON) and stop (OFF) of the SEQUENCE LOAD test and read the execution status.
Syntax	SEQLD:TEST{SP}{ON OFF}{; NL}
Query Syntax	SEQLD:TEST?{; NL}
Response	0(OFF), 1(ON)

9-3-2. Limit command

The limit command is used to read the settings and settings of various thresholds of the LSC series.

Command name	Brief description	Page
LIMit:CURRent:	Ith value of upper & lower limit current	88
LIMit:POWer:	Pth value of upper & lower limit power	88
LIMit:VOLTagE:	Vth value of upper & lower limit voltage	88
SVH SVL	Short test upper & lower volt Vth values	89
LIMit:ADDCV:VOLTagE	CV voltage value in CV + C/P limit mode	89
LIMit:ADDCV:CURRent	CV+CL mode current value	89
LIMit:ADDCV:POWer	CV+PL mode power value	90
LIMit:ADDCV	Select CV + C/P limit mode on / off	90

		Set →
		→ Query
LIMit:CURRent:{HIGH LOW} or {IH IL}		
Description	Set and read the upper (I_Hi) or lower (I_Lo) load current thresholds. The unit is "A". When the load current exceeds the threshold value, the NG display lights up to indicate "NO GOOD".	
Syntax	LIMit:CURRent:{HIGH LOW}{SP}{NR2}{; NL} or {IH IL}{SP}{NR2}{; NL}	
Query Syntax	[LIMit:CURRent:{HIGH LOW}]?{; NL} or {IH IL}?{; NL}	
Response	NR2	

		Set →
		→ Query
LIMit:POWer:{HIGH LOW} or {WH WL}		
Description	Set and read the upper (W_Hi) or lower (W_Lo) input power thresholds. The unit is "W". If the input power exceeds the threshold, the NG display lights up to indicate "NO GOOD".	
Syntax	[LIMit]:POWer:{HIGH LOW}{SP}{NR2}{; NL} or {WH WL}{SP}{NR2}{; NL}	
Query Syntax	LIMit:POWer:{HIGH LOW}]?{; NL} or {WH WL}?{; NL}	
Response	NR2	

		Set →
		→ Query
LIMit:VOLTage:{HIGH LOW} or {VH VL}		
Description	Set the input voltage threshold of the upper limit (V_Hi) or lower limit (V_Lo) and read. The unit is "V". If the input voltage exceeds the threshold value, the NG display lights up to indicate "NO GOOD".	
Syntax	LIMit:VOLTage:{HIGH LOW}{SP}{NR2}{; NL} or {VH VL}{SP}{NR2}{; NL}	
Query Syntax	LIMit:VOLTage:{HIGH LOW}]?{; NL} or {VH VL}?{; NL}	
Response	NR2	

		Set →
		→ Query
SVH SVL		
Description	Set and read the upper (V_Hi) or lower (V_Lo) voltage threshold of the Short test. The unit is "V". When the input voltage exceeds the threshold value, the NG display lights up and "NO GOOD" is displayed.	
Syntax	{SVH SVL}{SP}{NR2}{; NL}	
Query Syntax	{SVH SVL}?{; NL}	
Response	NR2	

		Set →
		→ Query
LIMit:ADDCV:VOLTage		
Description	Set and read the constant voltage value (Add CV) in CV + C/P limit mode. The unit is "V". In CV + C limit mode, the load operates in CC mode until the EUT voltage equals the set constant voltage value, then switches to constant voltage mode. In CV + P limit mode, the load operates in CP mode until the EUT voltage equals the set constant voltage value, then switches to constant voltage mode.	
Syntax	LIMit:ADDCV:VOLTage{SP}{NR2}{; NL}	
Query Syntax	LIMit:ADDCV:VOLTage?{; NL}	
Response	NR2	

		Set →
		→ Query
LIMit:ADDCV:CURRent		
Description	Set and read the constant current value in CV+C limit mode. The unit is "A".	
Syntax	LIMit:ADDCV:CURRent{SP}{NR2}{; NL}	
Query Syntax	LIMit:ADDCV:CURRent?{; NL}	
Response	NR2	
Note	The current value can be set with this command while the CV+C limit mode is running. While CV+C limit mode is stopped, set the current value with the "CURR:HIGH" command.	

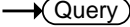
LIMit:ADDCV:POWer

Description	Set and read the constant power value in CV+P limit mode. The unit is "W".
Syntax	LIMit:ADDCV:POWer{SP}{NR2}{; NL}
Query Syntax	LIMit:ADDCV:POWer?{; NL}
Response	NR2
Note	The power value can be set with this command while the CV+P limit mode is running. While CV+P limit mode is stopped, set the power value with the "CP:HIGH" command.

LIMit:ADDCV:VOLTage {ON|OFF}

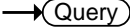

Description	Set CV + C/P limit mode to start and stop, and read the execution status. CV + C/P limit runs according to the current constant current mode or constant power mode.
Syntax	[LIMit:]ADDCV{SP}{ON OFF}{; NL}
Query Syntax	LIMit:ADDCV?{; NL}
Response	0(OFF), 1(ON)

9-3-3. Status command

Status commands are used to read the status settings and status settings status of the LSC series.

Command name	Brief description	Page
LOAD	Select LOAD on / off	91
MODE	Select discharge mode	91
SHORT	Select Short test on / off	91
PRESet	Setting value display	91
SENSe	Select remote sense connection	92
LEVeL	Select Static mode level	92
DYNAmic	Select Dynamic mode on / off	92
CLR	Clear error flag	92
NG?	NG flag reedback	93
PROTeCt?	Protective function operating state readback	93
CCR	Select CC mode Lange	93
NGENABLE	Select GO / NG judgment function on / off	94

POLAR	Select Voltage polarity display	94
START	Start of Test function (TCONFIG)	94
STOP	START command stop	94
TESTING?	Test function operating state readback	94

 →
 → 

LOAD

Description	Set and read on LOAD on / off.
Syntax	[STATE:]LOAD{SP}{ON OFF}{; NL}
Query Syntax	[STATE:]LOAD?{; NL}
Response	NR1(0: on, 1: off)

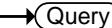
 →
 → 

MODE

Description	Set and read the discharge mode.
Syntax	[STATE:]MODE{SP}{CC CR CV CP}{; NL}
Query Syntax	[STATE:]MODE?{; NL}
Response	NR1(0: CC, 1: CR, 2: CV, 3: CP)

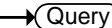
 →
 → 

SHORT

Description	Set and read the start (ON) / end (OFF) of the Short test.
Syntax	[STATE:]SHORT{SP}{ON OFF}{; NL}
Query Syntax	[STATE:]SHORT?{; NL}
Response	NR1(0: OFF, 1: ON)

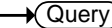
 →
 → 

PRESet

Description	The set value is displayed on the LCD display. ON: The set value is displayed on the LCD display. OFF: The current load status (V / A / W) is displayed on the LCD display.
Syntax	[STATE:]PRESet{SP}{ON OFF}{; NL}
Query Syntax	[STATE:]PRESet?{; NL}
Response	NR1(0: OFF, 1: ON)

		Set →
		→ Query
SENSe		
Description	Select from which point the voltage value displayed by the LSC series should be read. ON: Voltage value from the rear V sense input terminal. AUTO: Voltage value from the rear V sense input terminal. If there is no voltage from the rear V sense input terminal, the voltage value from the rear DC input terminal.	
Syntax	[STATe:]SENSe{SP}{ON AUTO }{; NL}	
Query Syntax	[STATe:]SENSe?{; NL}	
Response	NR1(0: AUTO, 1: ON)	

		Set →
		→ Query
LEVel		
Description	The static mode selects and reads the preset values (High and Low load level) of each discharge (CC / CR / CV / CP) mode. HIGH: High load level, LOW: Low load level	
Syntax	[STATe:]LEVel{SP}{HIGH LOW }{; NL}	
Query Syntax	[STATe:]LEVel?{; NL}	
Response	NR1(0: Low load level, 1: High load level)	

		Set →
		→ Query
DYnamic		
Description	Set whether the LSC series operation is dynamic mode or static mode, and read. ON: Dynamic mode, OFF: Static mode	
Syntax	[STATe:]DYnamic{SP}{ON OFF}{; NL}	
Query Syntax	[STATe:]DYnamic?{; NL}	
Response	NR1(1: Dynamic mode, 2: Static mode)	

		Set →
CLR		
Description	Clears the error flag that occurred during the operation of the LSC series. This command is for clearing the contents of the PROT and ERR registers. After execution, the contents of these two registers will be "0".	
Syntax	[STATe:]CLR{; NL}	

NG?

→ Query

Description Query if there is NG flag in this LSC series. The command "NG?" is used to show the NG status.
0: NG (NO GOOD) This means that the LCD is off.
1: It means that the NG LCD (GO) is lit.

Query Syntax [STaTe:]NG?{;|NL}

Response SR1(0: NO GOOD, 1: GO)

PROTeCt?

→ Query

Description Query whether the protection function of the LSC series has worked.
The command CLR clears the PROT status register to "0".
Responses are bit-weight.
Occurrence of a reverse voltage connection is not registered in PROT status.

Query Syntax [STaTe:]PROTeCt?{;|NL}

Response NR1

Register of PROT status	Bit 7	Bit 6	Bit 5	Bit 4	Bit 3	Bit 2	Bit 1	Bit 0
	128	64	32	16	8	4	2	1
					OCP	OVP	OTP	OPP

Bit ID	Bit value	Note
bit 0	0=Off, 1=Triggered	OPP
bit 1	0=Off, 1=Triggered	OTP
bit 2	0=Off, 1=Triggered	OVP
bit 3	0=Off, 1=Triggered	OCP

Set →

CCR

→ Query

Description Set RANGE in CC mode.
AUTO: RANGE AUTO, R2: RANGEII

Syntax [STaTe:]CCR{SP}{AUTO|R2}{;|NL}

Query Syntax [STaTe:] CCR?{;|NL}

Response SR1(AUTO: 0, RANGEII: 1)

NGENABLE

Set →

Description Set the GO / NG check function ON / OFF. This command is the ON / OFF setting for the Limit key operation NG item.
ON: GO / NG check function ON
OFF: GO / NG check function OFF

Syntax [STaTe:]NGENABLE{SP}{ON|OFF}{;|NL}

POLAR

Set →→ **Query**

Description Select POS / NEG and set the input voltage polarity. This command is the + LOAD / -LOAD setting for the CONF key operation POLAR item.
POS: +LOAD, NEG: -LOAD

Syntax [STaTe:]POLAR{SP}{POS|NEG}{;|NL}

Query Syntax [STaTe:] POLAR?{;|NL}

Response SR1(NEG: 0, POS: 1)

START

Set →

Description Starts execution of the TEST function set by the "TCONFIG (TEST CONFIG)" command.

Syntax [STaTe:]START{;|NL}

STOP

Set →

Description Stops the TEST function running with the "START" command.

Syntax [STaTe:]STOP{;|NL}

TESTING?

→ **Query**

Description Query to whether the LSC series is in the test execution state.

Query Syntax [STaTe:]TESTING?{;|NL}

Response SR1(0: Test end, 1: During testing)

9-3-4. System command

System commands are used to read the LSC series system settings and system settings.

コマンド名	簡易説明	Page
RECall	Query the various setting states	95
STORe	Saving the various setting states	95
NAME?	Query the LSC series model name	95
REMOTE	Remote state setting	95
LOCAL	Local state setting	96

RECall

Set →

Description It is possible to recall various setting states of 150 types of LSC series stored in the LSC series memory. The setting range is 1-150.

Syntax [SYStem:]RECall{SP}{NR1}{;|NL}

STORe

Set →

Description LSC series Various setting states are saved in the LSC series memory with an arbitrary number of 1-150. The setting range is 1-150.

Syntax [SYStem:]STORe{SP}{NR1}{;|NL}

NAME?

→ Query

Description Query to the model number of LSC series. If LSC series is no operating, the display will be "NULL".

Query Syntax [SYStem:]NAME?{;|NL}

Response It will be the model number as display in following table.

LSC402-151	LSC402-601	LSC402-122
LSC502-151	LSC502-601	LSC502-122
LSC602-151	LSC602-601	LSC602-122

REMOTE

Set →

Description This is a command to enter the REMOTE status. This command is for controlling RS232.

Syntax [SYStem:]REMOTE{;|NL}

LOCAL

Set →

Description This command ends the REMOTE status (RS232 only). This command is for ending control of RS232.

Syntax [SYStem:]LOCAL{;|NL}

9-3-5. Measure command

Measure commands are used to read the measurement status of the LSC series.

Command name	Brief description	Page
MEASure:CURRent	Load current readback	96
MEASure:VOLTagE	Input voltage readback	96
MEASure:POWer	Input power readback	96

MEASure:CURRent?

→ **Query**

Description Read the load current. Read the 5-digit number on the ammeter. The unit is "A".

Query Syntax MEASure:CURRent?{;|NL}

Response NR2

MEASure:VOLTagE?

→ **Query**

Description Read the input voltage. Read the 5-digit number on the voltmeter. The unit is "V".

Query Syntax MEASure:VOLTagE?{;|NL}

Response NR2

MEASure:POWer?

→ **Query**

Description Read the input power. Read the 5-digit number on the wattmeter. The unit is "W".

Query Syntax MEASure:POWer?{;|NL}

Response NR2

9-3-6. AUTO Sequence command

The AUTO Sequence command is used to read the LSC series automated test settings and automated test configuration status.

Command name	Brief description	Page
FILE	Setting the automatic test number	97
STEP	Setting the step number of the automatic test	97
SB	Setting the step execution content	98
TIME	Setting the step execution time	98
TOTSTEP	Set the number of steps for automatic test	98
SAVE	Save the automatic test	98
REPEAT	Automatic test execution count setting	99
RUN	Automated test execution	99
EXIT	Automated test stop	99

Set →

FILE

→ Query

Description	Reads the automatic test number setting of the AUTO Sequence function and the set automatic test number. The setting range is 1-9, and the number is the automatic test number.
Syntax	FILE{SP}{NR1}{; NL}
Query Syntax	FILE ?{; NL}
Response	NR1(1: Automatic tests 1, ... 9: Automatic tests 9)

Set →

STEP

→ Query

Description	Reads the step setting of the automatic test number set by the "FILE" command and the set step number. The setting range is 1-16, which is the step number.
Syntax	STEP{SP}{NR1}{; NL}
Query Syntax	STEP?{; NL}
Response	NR1(1: Step 1, ... 16: Step 16)

SB

Description	Set the step execution content to the step with the automatic test number set by the "STEP" command. The step execution contents are various setting states (up to 150 types) saved in the LSC series memory. The setting range is 1: Various setting states 1 – 150: Various setting states 150.
Syntax	SB{SP}{NR1}{; NL}

TIME

Description	Set the step execution time of the automatic test number set by the "STEP" command, and read the set step execution time. The setting range is 100-9999, and the unit is "ms".
Syntax	TIME{SP}{NR1}{; NL}
Query Syntax	TIME?{; NL}
Response	NR1

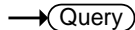
TOTSTEP

Description	Reads the total number of steps set for the automatic test number set by the "FILE" command and the total number of steps set. Setting range: 1-16
Syntax	TOTSTEP{SP}{NR1}{; NL}
Query Syntax	TOSTEP?{; NL}
Response	NR1

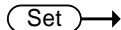
SAVE

Description	Saves the settings of the automatic test number set by the "FILE" command.
Syntax	SAVE{; NL}

		Set →
REPEAT		→ Query
Description	Reads the execution repeat count setting of the automatic test number set by the "FILE" command and the set repeat count. Setting range: 0-9999	
Syntax	REPEAT{SP}{NR1}{; NL}	
Query Syntax	REPEAT?{; NL}	
Response	NR1	
RUN		Set →
Description	Specify an automatic test number and run the automatic test against that number. Specified range: 1 to 9 When the automatic test is finished, you will receive an auto reply. Use the "EXIT" command to abort an automated test executed with the "RUN" command.	
Syntax	RUN{SP}{F}{NR1}{; NL}	
EXIT		Set →
Description	Stops a running automated test.	
Syntax	EXIT{; NL}	

10. application

This chapter describes the basic operating modes and some common applications in which the LSC series is used.

10-1. V sense terminal

Effect of using V sense terminal A voltage drop occurs when a current flows through the load line between the DUT output terminal and the LSC series DC input terminal. When the V sense terminal is connected to the DUT output terminal (remote sense connection), the voltage display of the LSC series displays the output terminal voltage of the DUT. In that case, the LSC series can perform discharge that compensates for the load line voltage drop.

Usage without using the V sense terminal The LSC series, which does not use the V sense terminal, can be used when the load line is relatively short or where load regulation is not important. The discharge mode of the LSC series is CC mode.

Usage using the V sense terminal If the load line is long, the load line voltage drop due to the load current will be large. If the LSC series is used in a discharge (CR, CV, CP) mode other than CC mode, the setting accuracy will deteriorate due to the effect of this load line voltage drop. When using the LSC series in CR, CV or CP mode, make a remote sense connection and use the LSC series.



Do not connect the V sense + terminal to the DUT output negative terminal and the V sense- terminal to the DUT output positive terminal. The LSC series may break down.

10-2. CC mode

Description The LSC series is in CC mode and can perform static mode that keeps a constant current value flowing. It is also possible to switch between High and Low load level current by static mode. In dynamic mode, the load current (High and Low load level current) can be switched over time. For details on dynamic mode, refer to "1-3-6. Dynamic mode " and "2-3-4. DYN/STA key".

The LSC series can input an external voltage to the analog voltage input terminal and operate the load current value in CC mode. If the external voltage is an oscillator that outputs a complex dynamic waveform, the LSC series can carry a complex dynamic load current. For the analog voltage input terminal, refer to "3-4. Analog voltage input terminal".

CC mode allows you to test the load regulation, cross regulation, output voltage, and dynamic regulation of the voltage source. CC mode can also be used to test the discharge characteristics and life cycle of cells and battery packs.

Main applications for Static mode	Voltage source test Voltage source load regulation test Battery discharge test
Main applications for Dynamic mode	Voltage source load transient response test Power recovery time test Battery pulse load simulation

10-3. CV mode

Description	CV mode is a discharge mode with the following features. The load current is passed so that the current source output voltage becomes the LSC series set voltage value. If the current source output voltage is lower than the LSC series set voltage value, the load current will not flow. The load current is the output current of the current source. The CV mode with the above characteristics can be used for the load regulation test of the current source and the inspection of the current limiting characteristics of the DC power supply.
Description of current source load regulation test	A typical example of a DC current source is a battery charger. Most battery chargers are designed to automatically adjust the charging current according to the battery voltage. CV mode allows you to measure the charging current at any voltage. By setting multiple set voltage values in CV mode and measuring the LSC series load current at that time, the current curve characteristics of the battery charger can be measured.
Description of inspection of current limiting characteristics of DC power supply	Fixed output type power supplies have a general current limit of foldback. For variable output type CV / CC power supplies, constant current is the general current limit. By setting multiple set voltage values in CV mode and measuring the LSC series load current at that time, the current limiting characteristics of the power supply can be measured.

10-4. CR mode

Description	CR mode is a discharge mode that can be used for both voltage and current sources. CR mode can be used for power boot testing of voltage or current sources. It can also be used for operation mode transition tests for CV / CC power supplies that have both voltage and current functions.
Description of power boot test	When the LSC series is set to LOAD on and CC mode, and then the power of the voltage source is turned on, the voltage of the voltage source exceeds the LDon (LOAD on) voltage, and the set load current flows.

At this time, the voltage source output voltage drops once due to a sudden increase in load current as shown in the figure below. If the LDon voltage is low, the voltage source may not be able to output the voltage of normal operation due to the protection circuit (short circuit or overcurrent) of the voltage source.

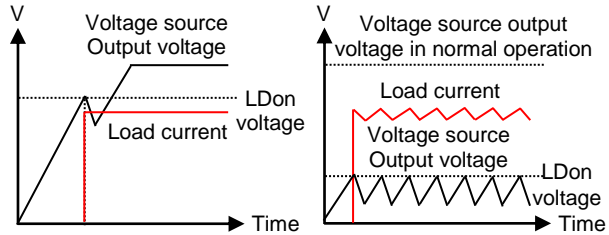

When the LSC series is set to CR mode, the voltage source voltage and load current operate in a proportional relationship. In addition, the current source current and the input voltage value also operate in a proportional relationship. (For the proportional relational expression, refer to "1-3-2. CR mode".)

When the LSC series is set to LOAD on and CR mode, and then the power of the voltage source is turned on, the load current increases from 0A in proportion to the output voltage of the voltage source.

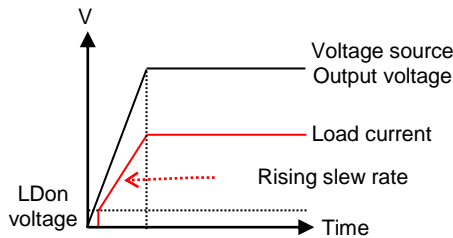

Similarly, in the case of a current source, when the output of the current source is turned from off to on, the load voltage rises from 0V in proportion to the output current of the current source.

Note

Set the rising slew rate earlier than the slew rate of the voltage source output voltage. For the slew rate, refer to "1-3-5. Slew rate".

Description of CV / CC power supply operation mode transition test

The output characteristics of the CV / CC power supply are as shown in the figure below. The operation mode of the CV / CC power supply is CV mode when the set resistance value is from infinity to A / B [Ω] (green line part), and the set resistance value is from 0 [Ω] to A / B [Ω]. Between (red line part) is CC mode. When the LSC series set resistance value

is set to $A / B [\Omega]$ (crossover point: COP, blue O), the operation mode of the CV / CC power supply is either CV or CC mode.

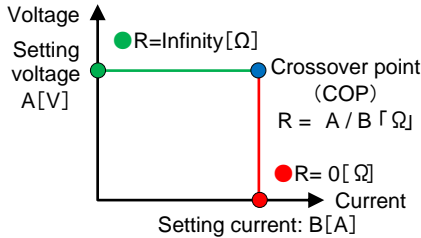

By using the CR mode of the LSC series and setting a resistance value smaller than COP from a resistance value larger than COP, the CV → CC mode transition characteristics of the CV / CC power supply can be confirmed. Similarly, by setting a resistance value smaller than COP to a resistance value larger than COP, the CC → CV mode transition characteristics of the CV / CC power supply can be confirmed.

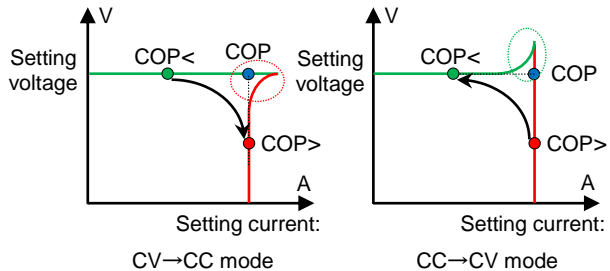

It is convenient to use the Level key to switch between a resistance value higher than COP (COP <) and a resistance value smaller than COP (COP >). At this time, set the high load level to a resistance value smaller than COP, and set the low load level to a resistance value larger than COP.

10-5. CP mode

Description

In CP mode, the load current flows with the set power. CP mode is the best discharge mode for battery evaluation. The LSC series can evaluate the battery in static mode and battery evaluation in dynamic mode. In addition, as a battery over-discharge prevention function, you can set the voltage (LDoff voltage) that the LSC series will LOAD off. For the LDoff voltage, refer to "2-3-9. CONF key".

Battery evaluation in static mode

If the LSC series is set to CP mode and the battery is discharged with arbitrary power, the battery output voltage will decrease and the output current will increase.

By measuring the passage of time and the output voltage and output current of the battery, the battery discharge characteristics due to constant power discharge can be confirmed.

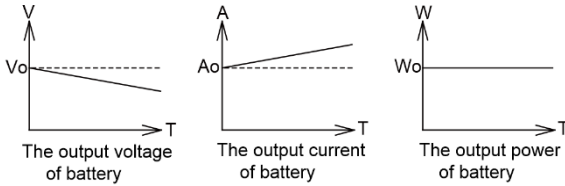

Battery evaluation in dynamic mode

In dynamic mode, the load power (High and Low load level power) can be switched over time. For details on dynamic mode, refer to "1-3-6. Dynamic mode" and "2-3-4. DYN/STA key".

The LSC series can operate the load power value in CP mode by inputting an external voltage to the analog voltage input terminal. If the external voltage is an oscillator that outputs a complex dynamic waveform, the LSC series can set a complex dynamic load power. For the analog voltage input terminal, refer to "3-4. Analog voltage input terminal".

10-6. CV+C limit mode

Description

The LSC series can operate in CV + C limit mode.

If the output voltage of the voltage source is larger than the set voltage in CV mode, the LSC series will carry the load current in CC mode. It is the section of Constant Current in the figure below.

After that, when the voltage of the voltage source reaches the voltage set in CV mode, the LSC series maintains that voltage and the load current decreases. It is the section of Constant Voltage in the figure below.

If the voltage of the voltage source is smaller than the voltage set in CV mode, the LSC series does not carry the discharge current.

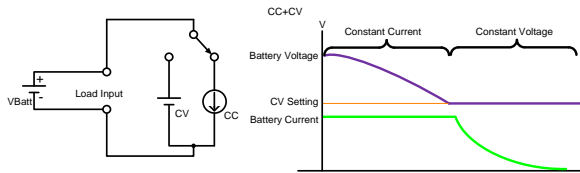

Remote control example of CV + C limit mode operation

REMOTE

Remote control settings

MODE CC

Set to CC mode

CC:HIGH 20

Set the load current to 20A

LIM:ADDCV:VOLT 50	Set the constant voltage value to 50V
LIM:ADDCV ON	CV + C limit mode test start
MEAS:CURR?	Read the current value
MEAS:VOLT?	Read the voltage value
LIM:ADDCV OFF	Stop CV + C limit test

10-7. CV+P limit mode

Description The LSC series can operate in CV + P limit mode.

If the output voltage of the voltage source is larger than the set voltage in CV mode, the LSC series will carry the load current in CP mode. It is the section of Constant Power in the figure below.

After that, when the voltage of the voltage source reaches the voltage set in CV mode, the LSC series maintains that voltage and the load current decreases. It is the section of Constant Voltage in the figure below.

If the voltage of the voltage source is smaller than the voltage set in CV mode, the LSC series does not carry the discharge current.

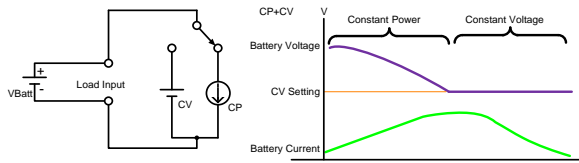

Remote control example of CV + P limit mode operation

REMOTE	Remote control settings
MODE CP	Set to CP mode
CP: HIGH 100	Set the load power to 100W
LIM:ADDCV:VOLT 50	Set the constant voltage value to 50V
LIM:ADDCV ON	CV + P limit mode test start
MEAS:POW?	Read the power value
MEAS:VOLT?	Read the voltage value
LIM:ADDCV OFF	Stop CV + P limit test

10-8. Constant current source operation

Description The LSC series can be used as a constant current source by connecting it in series with a constant voltage source. Applications for constant current sources include diode energization tests and battery charging.

Connection example as a constant current source

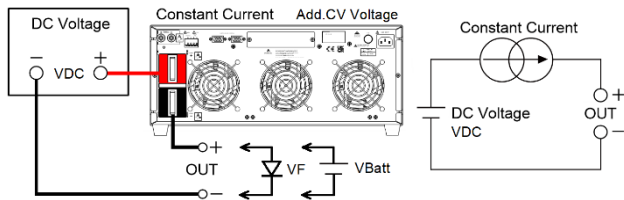

Diode energization test

This test will be conducted in CC mode. Set the current value flowing through the diode in CC mode of the LSC series.

The output voltage (VDC) of the power supply connected in series with the LSC series should be equal to or higher than the VF voltage of the diode, the minimum operating voltage of the LSC series, and the load line voltage drop. ($VDC > \text{minimum operating voltage} + VF + \text{load line voltage drop}$)

When the LSC series is used in dynamic mode, the pulse current energization test of the diode can be performed.

Battery charging

Full charge is performed in CV + C limit mode.

Set the battery charge current in LSC series CC mode.

Set the voltage in CV mode of LSC series. To set the voltage in CV mode, set "Add.CV item of 2-3-8. Limit key".

The voltage of the voltage source connected in series with the LSC series (VDC), the charging voltage of the battery (VBatt) and the voltage in CV mode (Add.CV) have the following relational expressions.

$$VBatt = VDC - Add.CV$$

Also, set the Add.CV voltage for the LSC series higher than the sum of the minimum operating voltage of the LSC series and the load line voltage drop. ($Add.CV > \text{Minimum operating voltage} + \text{load line voltage drops}$)

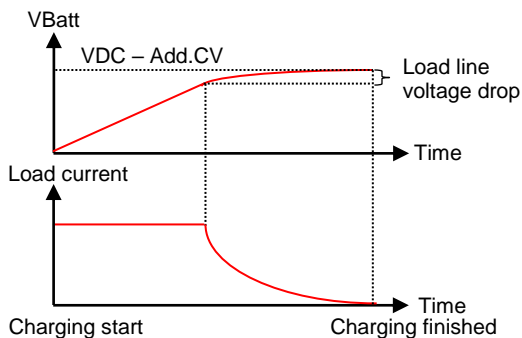

Note

The minimum operating voltage of the LSC series changes depending on the current value set in CC mode. For the minimum operating voltage, refer to "1-4. Operating range".

10-9. Zero-volt load

Description The LSC series can discharge the DUT to the zero volt state by connecting in series with a DC voltage source that outputs a voltage higher than the minimum operating voltage of the LSC series. This allows the low voltage battery cell to be discharged.

Zero-volt load connection Connect the DC voltage source, DUT, and DC input terminal as shown in the figure below. When using the V sense terminal, connect V sense + and DUT +, and connect V sense- and DUT-.

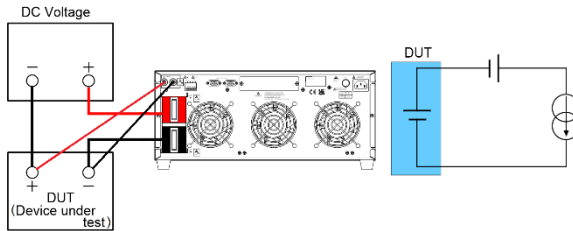

When the V sense terminal is not used, the voltage display of the LSC series is the voltage obtained by subtracting the voltage of the DC voltage source from the DUT voltage.

When using the V sense terminal, set SENCE to "ON" and set the LDoff voltage. By setting the LDoff voltage to 0V, the DUT can be discharged to 0V. At this time, the voltage display of the LSC series is the DUT voltage. For details on how to set SENCE and LDoff, refer to "2-3-9. CONF key".

Note The minimum operating voltage of the LSC series changes depending on the load current value flowing through the LSC series. For the minimum operating voltage, refer to "1-4. Operating range".

10-10. Parallel operation

Description If the LSC series alone does not have sufficient power and / or current capacity, it is possible to connect and operate the LSC series in parallel.

This usage is static mode and can operate in CC, CR or CP mode. Set and operate each LSC series connected in parallel on each LSC series. The total load current is the total load current flowing through each LSC series.



The LSC series cannot be used in series connection.

In the case of dynamic mode, it is not possible to synchronize the switching timing between High load level and Low load level.

It cannot be operated with the AUTO Sequence function.

Parallel connection of LSC series

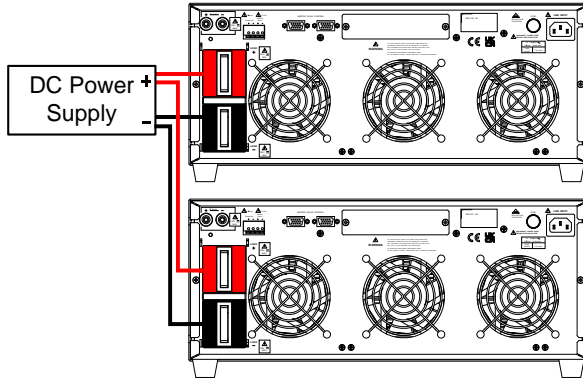

10-11. OCP test setting example

The following is an example of manual control settings for the OCP test.

State	Description
1	<p>Operate the Limit key to set the upper limit of the load current to 2A.</p>
2	<p>Operate the Limit key to set the lower limit of the load current to 0A.</p>
3	<p>Set up the OCP test and press the OCP key to proceed to the next step.</p>
4	<p>Set the test start current value to 0A and press the OCP key to proceed to the next step.</p>
5	<p>Set the increasing current value to 0.05A and press the OCP key to proceed to the next step.</p>
6	<p>Set the test end current value to 5A and press the OCP key to proceed to the next step.</p>
7	<p>Set the lower voltage threshold to 6.00V and press the OCP key to proceed to the next step.</p>
8	<p>When the LCD display is as shown on the left, press the Start / Stop key to start the OCP test.</p>





The load current increases with an increase current value of 0.05A.



The OCP test ends when the load current reaches the test end current value of 5A.

9



If the UUT output voltage drop is higher than the lower limit voltage threshold and the load current value is between the upper limit of the load current and the lower limit of the load current, "PASS" is displayed.



Otherwise, "FAIL" is displayed.

OCP test remote control example

REMOTE	Remote setting
IL 0	Set the current lower limit to 0A
IH 2	Set the current upper limit to 2A
TCONFIG OCP	Set up OCP test
OCP:START 0	Set the test start current value to 0A
OCP:STEP 0.05	Set the increased current value to 0.05A
OCP:STOP 5	Set the test end current value to 5A
VTH 6.0	Set the lower limit voltage threshold to 6.00V
NGENABLE ON	Set NG judgment to on
START	Start OCP test
TESTING?	Inquiries during the test, 1: During the test, 0: End of the test
NG?	Inquiry about NG flag, 0: PASS, 1: FAIL
OCP?	Inquiry about OCP current value
STOP	Stop OCP test

10-12. OPP test setting example

The following is an example of manual control settings for the OPP test.

State	Description
-------	-------------



Operate the Limit key to set the upper limit of the input power to 60W.



Operate the Limit key to set the lower limit of the input power to 0W.



Set up the OPP test and press the OPP key to proceed to the next step.



Set the test start power value to 0W and press the OPP key to proceed to the next step.



Set the power increase value to 0.5W and press the OPP key to proceed to the next step.



Set the test end power value to 100W and press the OPP key to proceed to the next step.



Set the lower voltage threshold to 6.00V and press the OPP key to proceed to the next step.



When the LCD display is as shown on the left, press the Start / Stop key to start the OPP test.

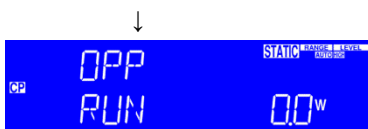

The load power increases with an increase power value of 0.5W.



The OPP test ends when the load power reaches the test end power value of 100W.



If the output voltage drop of the UUT is higher than the lower limit voltage threshold and the load power value is between the upper limit of the input power and the lower limit of the input power, "PASS" is displayed.







Otherwise, "FAIL" is displayed.

OPP test remote control example

REMOTE	Remote setting
WH 100	Set the upper limit of input power to 100W
WL 0	Set the lower limit of input power to 0W
TCONFIG OPP	Set up OPP test
OPP:START 0	Set the test start power value to 0W
OPP:STEP 0.5	Set the increased power value to 0.5W
OPP:STOP 5	Set the test end power value to 100W
VTH 6.0	Set the lower limit voltage threshold to 6.0V
NGENABLE ON	Set NG judgment to on
START	Start OPP test
TESTING?	Inquiries during the test, 1: During the test, 0: End of the test
NG?	Inquiry about NG flag, 0: PASS, 1: FAIL
OPP?	Inquiry about OPP current value
STOP	Stop OPP test

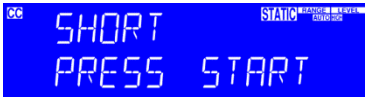
10-13. Short test setting example

The following is an example of manual control settings for the Short test.

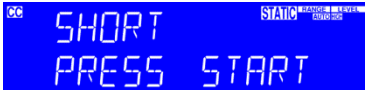
State	Discription	
1		Set up the short test and press the Short key to proceed to the next step.
2		Set the Short test time to 10000ms and press the Short key to proceed to the next step.
3		Set the upper voltage threshold to 1.00V and press the Short key to proceed to the next step.
4		Set the lower voltage threshold to 0V and press the Short key to proceed to the next step.
5		When the LCD display is as shown on the left, press the Start / Stop key to start the Short test.

6



At the end of the Short test, if the UUT's voltage drop is between the upper and lower voltage thresholds, the LCD display will show "PASS".

Otherwise, "FAIL" is displayed.

Short test remote control example

REMOTE	Remote setting
TCONFIG SHORT	Set Short test
STIME 10000	Set SHORT time to 10000ms
SVH 1.00	Set the upper limit voltage threshold to 1.00V
SVL 0.00	Set the lower limit voltage threshold to 0V
START	Start Short test
TESTING?	Inquiries during the test, 1: During the test, 0: End of the test
NG?	Inquiry about NG flag, 0: PASS, 1: FAIL
STOP	Stop Short test

10-14. Battery discharge test

There are four types of battery discharge applications: CC mode Batt test, CP mode Batt test, CV + C/P limit mode.

This section describes the Batt test in CC mode and the Batt test in CP mode. For details on CV + C/P limit mode, refer to "10-6. CV+C limit mode" and "10-7. CV+P limit mode".

10-14-1. Measuring battery capacity with Batt test

The battery discharge mode according to the Batt test can be selected from CC or CP mode. Select the discharge mode, set the discharge current or power value, and set the discharge stop voltage (STOP VOLTT.V). Set the discharge stop time (STOP TIME), discharge stop current time (STOP CAP.AH), and discharge stop power time (STOP CAP.WH) to "OFF". For details on how to set the Batt test, refer to "7-5. Batt test".

The Batt test ends when the battery voltage drops below the STOP VOLTT.V after starting the Batt test. At this time, the LSC series LCD display will display "OK" and the total discharge capacity (AH and WH).

Battery discharge
by Batt test in CC
mode

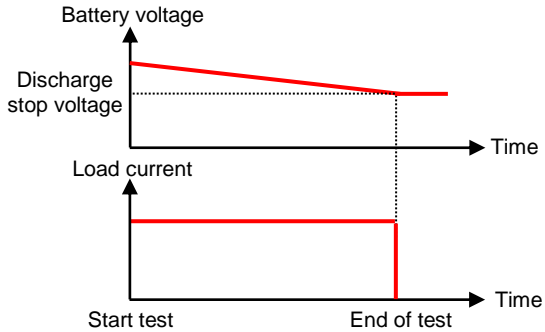

Battery discharge
by Batt test in CP
mode

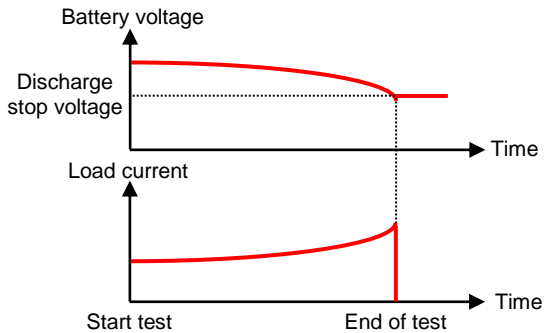

Batt test remote control example

REMOTE

Remote setting

BATT:CURR 10

CC mode: Set current value to 10A

BATT:POWER 100

CP mode: Set the set power value to 100W

BATT:UVP 12.0

Set the discharge stop voltage to 12V

BATT:TIME 0

Set the discharge stop time to OFF

BATT:AH 0

Set the discharge stop current time to OFF

BATT:WH 0

Set the discharge stop power time to OFF

BATT:TEST ON

Batt test started

BATT:RTIME

Batt test result time inquiry

BATT:RAH

Batt test result current time inquiry

BATT:RWH

Batt test results Power time inquiry

10-15. SEQUENCE LOAD test example

The SEQUENCE LOAD test is for REMOTE operation only.

The SEQUENCE LOAD test needs to set the number of steps from 2 to 16, and set the load value and time for each step. After the test starts, it will be repeated according to the set value until the voltage is less than the VTH value. Or receive a Stop command to stop the test.

LSC602-151 (600A/150V/6KW) remote operation example

REMOTE	Set remote control
RISE 24	Set rise slope24A/us
FALL 24	Set fall slope24A/us
SEQLD:TYPE CC	Set CC for SEQUENCE LOAD test
SEQLD:CC0 30	Set CC0=30A
SEQLD:CC?	Read C C0 value
SEQLD:TIME0 1000	Set TIME0=1000ms
SEQLD:TIME0?	Read TIME0 value
SEQLD:CC1 60	Set CC1=60A
SEQLD:TIME1 2000	Set TIME1=2000ms
SEQLD:CC2 15	Set CC2=15A
SEQLD:TIME2 500	Set TIME2=500ms
SEQLD:TOTSTEP 3	Set 3 STEP
SEQLD:TOTSTEP?	Read STEP setting
VTH 1	Set VTH=1V
SEQLD:TEST ON	Execute SEQUENCE LOAD test
SEQLD:TEST ON	Stop SEQUENCE LOAD test

11. LSC specifications

11-1. Default Settings

The following default settings are the factory configuration settings for the LSC series.

Model	LSC402-151	LSC502-151	LSC602-151
Item	Initial value		
CC L+Preset	0.000 A	0.000 A	0.000 A
CC H+Preset	0.000 A	0.000 A	0.000 A
CR H+Preset	22500.0 Ω	18000.0 Ω	15000.0 Ω
CR L+Preset	22500.0 Ω	18000.0 Ω	15000.0 Ω
CV H+Preset	150.00 V	150.00 V	150.00 V
CV L+Preset	150.00 V	150.00 V	150.00 V
CP L+Preset	0.00 W	0.0W	0.0W
CP H+Preset	0.00 W	0.0W	0.0W

Model	LSC402-601	LSC502-601	LSC602-601
Item	Initial value		
CC L+Preset	0.000 A	0.000 A	0.000 A
CC H+Preset	0.000 A	0.000 A	0.000 A
CR H+Preset	128568 Ω	102854 Ω	85712 Ω
CR L+Preset	128568 Ω	102854 Ω	85712 Ω
CV H+Preset	600.00 V	600.00 V	600.00 V
CV L+Preset	600.00 V	600.00 V	600.00 V
CP L+Preset	0.00 W	0.0 W	0.0 W
CP H+Preset	0.00 W	0.0 W	0.0 W

Model	LSC402-122	LSC502-122	LSC602-122
Item	Initial value		
CC L+Preset	0.000 A	0.000 A	0.000 A
CC H+Preset	0.000 A	0.000 A	0.000 A
CR H+Preset	450000 Ω	360000 Ω	22500 Ω
CR L+Preset	450000 Ω	360000 Ω	22500 Ω
CV H+Preset	1200.00 V	1200.0 V	1200.0 V
CV L+Preset	1200.00 V	1200.0 V	1200.0 V
CP L+Preset	0.00 W	0.0 W	0.0 W
CP H+Preset	0.00 W	0.0 W	0.0 W

Model	LSC402-151	LSC502-151	LSC602-151
Item	Initial value for Limit		
V_Hi	150.00 V	150.00 V	150.00 V
V_Lo	0.00 V	0.00 V	0.00 V
I_Hi	400.00 A	500.00 A	600.0 A
I_Lo	0.00 A	0.00 A	0.00 A
W_Hi	4000.0 W	5000.0 W	6000.0 W
W_Lo	0.0 W	0.0 W	0.0 W

Model	LSC402-601	LSC502-601	LSC602-601
Item	Initial value for Limit		
V_Hi	600.00 V	600.00 V	600.00 V
V_Lo	0.00 V	0.00 V	0.00 V
I_Hi	280.00 A	350.00 A	420.00 A
I_Lo	0.00 A	0.00 A	0.00 A
W_Hi	4000.0 W	5000.0 W	6000.0 W
W_Lo	0.0 W	0.0 W	0.0 W

Model	LSC402-122	LSC502-122	LSC602-122
Item	Initial value for Limit		
V_Hi	1200.00 V	1200.00 V	1200.00 V
V_Lo	0.00 V	0.00 V	0.00 V
I_Hi	160.00 A	200.00 A	240.00 A
I_Lo	0.00 A	0.00 A	0.00 A
W_Hi	4000 W	5000.0 W	6000.0 W
W_Lo	0.0 W	0.0 W	0.0 W

Model	LSC402-151	LSC502-151	LSC602-151
Item	Initial value for DYN		
T_Hi	2.000 ms	2.000 ms	2.000 ms
T_Lo	2.000 ms	2.000 ms	2.000 ms
RISE	0.2560 A/us	0.320 A/us	0.3840 A/us
FALL	0.2560 A/us	0.320 A/us	0.3840 A/us

Model	LSC402-601	LSC502-601	LSC602-601
Item	Initial value for DYN		
T_Hi	2.000 ms	2.000 ms	2.000 ms
T_Lo	2.000 ms	2.000 ms	2.000 ms
RISE	0.1792 A/us	0.2240 A/us	0.2688 A/us
FALL	0.1792 A/us	0.2240 A/us	0.2688 A/us

Model	LSC402-122	LSC502-122	LSC602-122
Item	Initial value for DYN		
T_Hi	2.000 ms	2.000 ms	2.000 ms
T_Lo	2.000 ms	2.000 ms	2.000 ms
RISE	0.1024 A/us	0.1280 A/us	0.1536 A/us
FALL	0.1024 A/us	0.1280 A/us	0.1536 A/us

Model	LSC402-151	LSC502-151	LSC602-151
Item	Initial value for CONFIG		
SENSE	Auto	Auto	Auto
LD-ON	2.50 V	2.50 V	2.50 V
LD-OFF	1.00 V	1.00 V	1.00 V
+LOAD	+LOAD	+LOAD	+LOAD

Model	LSC402-601	LSC502-601	LSC602-601
Item	Initial value for CONFIG		
SENSE	Auto	Auto	Auto
LD-ON	4.0 V	4.0 V	4.0 V
LD-OFF	0.5 V	0.5 V	0.5 V
+LOAD	+LOAD	+LOAD	+LOAD

Model	LSC402-122	LSC502-122	LSC602-122
Item	Initial value for CONFIG		
SENSE	Auto	Auto	Auto
LD-ON	10.0 V	10.0 V	10.0 V
LD-OFF	5.00 V	5.00 V	5.00 V
+LOAD	+LOAD	+LOAD	+LOAD

Model	All model
Item	Initial value
SHORT	Disable

OPP	Disable
OCP	Disable

11-2. LSC series Specifications

The specifications apply when the LSC series is powered on for at least 30 minutes. Note that the high frequency and high voltage options are listed as separate specifications.

11-2-1. LSC402-151

Rating		
Power ^{*1}	0 - 4kW, Turbo mode: 0 - 6kW max. ^{*1}	
Current	0 - 400A, Turbo mode: 0 - 600A max. ^{*1}	
Voltage	0 - 150V	
Min. Operating Voltage	0.7V@400A	
Protections		
OPP	105%	
OCP	104%	
OVP	105%	
OTP	90°C ± 5°C	
CC mode	RANGE I	RANGE II
Range ^{*2} /Resolution	0 - 40A / 0.64mA	0 - 400A / 6.4mA
Accuracy ^{*3}	± 0.05% of (Setting + Range)	
CR mode	RANGE I	RANGE II
Range ^{*2} / Resolution	22.5kΩ - 0.375Ω / 44.4uS	0.375Ω - 0.0018Ω / 6.25uΩ
Accuracy	± (0.1% (Vin / Setting) + 0.1% I F.S.)	± (0.2% (Vin / Setting) + 0.5% I F.S.) ^{*9}
CV mode		
Range / Resolution	0 - 150V / 2.5mV	
Accuracy	± 0.05% of (Setting + Range)	
CP mode	RANGE I	RANGE II
Range ^{*2} / Resolution	0 - 400W / 6.4mW	400W - 4kW / 64mW
Accuracy ^{*4}	± 0.2% of (Setting + Range)	
CV + C limit mode		
Range / Resolution	150V / 2.5mV	400A / 6.4mA
Accuracy ^{*4}	± 0.05% of (Setting + Range)	± 1.0% of (Setting + Range)
CV + P limit mode		
Range / Resolution	150V / 2.5mV	4kW / 64mW
Accuracy ^{*4}	± 0.05% of (Setting + Range)	± 1.0% of (Setting + Range)
Short / OCP / OPP test		
Turbo mode ^{*5}	OFF	ON
Max. Current	400A	600A ^{*1}
Max. Power	4000W	6000W ^{*1}

Accuracy ⁶	± 1.0% of (Reading + Range)	
SHORT TIME	100 - 10000ms, Continuous	100 - 2000ms
	Resolution: 100ms / Setting accuracy: ±5ms	
Short V Hi	Setting range: 0.00V - 150.00V / Resolution: 0.0025V	
Short V Lo	Setting range: 0.00V - 150.00V / Resolution: 0.0025V	
OCP Time (Tstep)	100ms / Setting accuracy: ±5ms	20ms / Setting accuracy: ±5ms
OCP ISTAR/ ISTEP/ISTOP	Setting range: 0.00A - 400.00A Resolution: 6.4mA	Setting range: 0.00A - 600.00A Resolution: 9.6mA
OCP VTH	Setting range: 0.00V - 150.00V / Resolution: 0.0025V	
OPP Time (Tstep)	100ms / Setting accuracy: ±5ms	20ms / Setting accuracy: ±5ms
OPP PSTAR/ PSTEP/PSTOP	Setting range: 0.00W - 4000.0W Resolution: 64.0mW	Setting range: 0.00W - 6000.0W Resolution: 96.0mW
OPP VTH	Setting range: 0.00V - 150.00V / Resolution: 0.0025V	

Batt test

Batt CC	Setting range: 0.00A - 400.00A / Resolution: 6.4mA	
Batt CP	Setting range: 0.00A - 4000.0W / Resolution: 64.0mW	
STOP Voltage	Setting range: 0.00V - 150.00V / Resolution: 0.0025V	
STOP TIME	Setting range: OFF, 1 - 99999s / Resolution: 1s	
STOP CAP.AH	Setting range: OFF, 0.1 - 19999.9AH / Resolution: 0.1AH	
STOP CAP.WH	Setting range: OFF, 0.1 - 19999.9WH / Resolution: 0.1WH	

BMS test⁷

Turbo mode ⁵	OFF	ON
Max. Current	400A	600A
Meas. Accuracy ⁶	± 3.0% of (Reading + Range)	
Short test time	Setting range: 0.05 ~ 10ms / Resolution: 0.01ms	
Accuracy	Meas.: ± 0.02ms / Setting: ± 0.05ms	
Short ITH	Setting range: 0.19A - 200.00A / Resolution: 6.4mA	Setting range: 0.28A - 300.00A / Resolution: 9.6mA
OCP ISTAR	Setting range: 0.64A - 400.00A / Resolution: 6.4mA	Setting range: 0.96A - 600.00A / Resolution: 9.6mA
OCP TSTEP	Setting range: 0.05 - 10ms, 11 - 1000ms / Resolution: 1us, 1ms	Setting range: 0.05 - 10ms / Resolution: 1us
Meas. Accuracy	± 0.1ms, ± 0.5ms	± 0.5ms
OCP ISTEP	Setting range: 0.00A - 400.00A / Resolution: 6.4mA	Setting range: 6.00A - 600.00A / Resolution: 9.6mA
OCP ISTOP	Setting range: 0.64A - 400.00A / Resolution: 6.4mA	Setting range: 0.96A - 600.00A / Resolution: 9.6mA
OCP ITH	Setting range: 0.19A - 200.00A / Resolution: 6.4mA	Setting range: 0.29A - 300.00A / Resolution: 9.6mA

Surge test

SUR.I	0 - 600A
NOR.I	0 - 300A
S.TIME	10 - 2000ms

S.STEP 1 - 5

SEQUENCE LOAD test

Discharge mode CC / CP

No. of setting steps 2 - 16

Step time range 20 - 100us / 2 - 65535ms / 66 - 999s

Resolution 10us / 1ms / 1s

Dynamic mode RANGE I RANGE II

Timing

Thigh & Tlow 0.010 - 9.999 / 10.00 - 99.99 / 100.0 - 999.9 / 1000 - 9999ms

Resolution 0.001 / 0.01 / 0.1 / 1ms

Setting accuracy 1us / 10us / 100us / 1ms + 50ppm

Slew rate 0.0256 - 1.600A/us 0.2560 - 16.000A/us

Resolution 0.0064A/us 0.064A/us

Min. Rise Time 25us (typical)

Setting accuracy \pm (5% of Setting + 10 μ s)

Current

Setting range 0 - 40A 40 - 400A

Resolution 0.64mA 6.4mA

Conf key parameter

Load ON voltage Setting range: 0.25V - 62.50V / Resolution: 0.25V

Load OFF voltage Setting range: 0.000V - 62.250V / Resolution: 0.0025V

Average time 0 - 64

CV res. speed 1 - 4 (Fastest)

Measurement

Voltage Read Back

Range (5 Digital) 0 - 15V 15 - 150V

Resolution 0.25mV 2.5mV

Meas. Accuracy \pm 0.025% of (Reading + Range)

Current Read Back

Range (5 Digital) 0 - 40A 40 - 400A

Resolution 0.64mA 6.4mA

Meas. Accuracy \pm 0.05% of (Reading + Range)

Power Read Back

Range (5 Digital) 4kW

Resolution 0.01W

Meas. Accuracy*4 \pm 0.06% of (Reading + Range)

General

Remote Sensing Voltage that can be Compensated:
Below the total rated voltage on both sides
However, the V sense terminal voltage and DC input terminal voltage
must be used within the operating range.

Resistance When V sense terminal is not used: 1.2M Ω typical
when LOAD OFF When V sense terminal is used: 600k Ω typical

Short resistance	1.8mΩ typical
Max. Short Current	400A
Load ON Voltage	0.25 - 62.5V
Load OFF Voltage	0 - 62.25V
Weight	32.0kg

11-2-2. LSC502-151

Rating

Power ^{*1}	0 - 5kW, Turbo mode: 0 - 7.5kW max. ^{*1}
Current	0 - 500A, Turbo mode: 0 - 750A max. ^{*1}
Voltage	0 - 150V
Min. Operating Voltage	0.7V@500A

Protections

OPP	105%
OCP	104%
OVP	105%
OTP	90°C ± 5°C

CC mode

	RANGE I	RANGE II
Range ^{*2} /Resolution	0 - 50A / 0.80mA	0 - 500A / 8.0mA
Accuracy ^{*3}	± 0.05% of (Setting + Range)	

CR mode

	RANGE I	RANGE II
Range ^{*2} / Resolution	18kΩ - 0.3Ω / 55.6uS	0.3Ω - 0.0015Ω / 5uΩ
Accuracy	± (0.1% (Vin / Setting) + 0.1% I F.S.)	± (0.2% (Vin / Setting) + 0.5% I F.S.) ^{*9}

CV mode

Range / Resolution	0 - 150V / 2.5mV
Accuracy	± 0.05% of (Setting + Range)

CP mode

	RANGE I	RANGE II
Range ^{*2} / Resolution	0 - 500W / 8mW	500W - 5kW / 80mW
Accuracy ^{*4}	± 0.2% of (Setting + Range)	

CV + C limit mode

Range / Resolution	150V / 2.5mV	500A / 8mA
Accuracy ^{*4}	± 0.05% of (Setting + Range)	± 1.0% of (Setting + Range)

CV + P limit mode

Range / Resolution	150V / 2.5mV	5kW / 80mW
Accuracy ^{*4}	± 0.05% of (Setting + Range)	± 1.0% of (Setting + Range)

Short / OCP / OPP test

Turbo mode ^{*5}	OFF	ON
Max. Current	500A	750A ^{*1}
Max. Power	5000W	7500W ^{*1}
Accuracy ^{*6}	± 1.0% of (Reading + Range)	

SHORT TIME	100 - 10000ms, Continuous	100 - 2000ms
	Resolution: 100ms / Setting accuracy: ± 5 ms	
Short V Hi	Setting range: 0.00V - 150.00V / Resolution: 0.0025V	
Short V Lo	Setting range: 0.00V - 150.00V / Resolution: 0.0025V	
OCP Time (Tstep)	100ms / Setting accuracy: ± 5 ms	20ms / Setting accuracy: ± 5 ms
OCP ISTAR/ ISTEP/ISTOP	Setting range: 0.00A - 500.00A Resolution: 8.0mA	Setting range: 0.00A - 750.00A Resolution: 12mA
OCP VTH	Setting range: 0.00V - 150.00V / Resolution: 0.0025V	
OPP Time (Tstep)	100ms / Setting accuracy: ± 5 ms	20ms / Setting accuracy: ± 5 ms
OPP PSTAR/ PSTEP/PSTOP	Setting range: 0.00W - 5000.0W Resolution: 80.0mW	Setting range: 0.00W - 7500.0W Resolution: 120mW
OPP VTH	Setting range: 0.00V - 150.00V / Resolution: 0.0025V	

Batt test

Batt CC	Setting range: 0.00A - 500.00A / Resolution: 8.0mA	
Batt CP	Setting range: 0.00A - 5000.0W / Resolution: 80.0mW	
STOP Voltage	Setting range: 0.00V - 150.00V / Resolution: 0.0025V	
STOP TIME	Setting range: OFF, 1 - 99999s / Resolution: 1s	
STOP CAP.AH	Setting range: OFF, 0.1 - 19999.9AH / Resolution: 0.1AH	
STOP CAP.WH	Setting range: OFF, 0.1 - 19999.9WH / Resolution: 0.1WH	

BMS test⁷

Turbo mode ⁵	OFF	ON
Max. Current	500A	750A
Meas. Accuracy ⁶	$\pm 3.0\%$ of (Reading + Range)	
Short test time	Setting range: 0.05 ~ 10ms / Resolution: 0.01ms	
Accuracy	Meas.: ± 0.02 ms / Setting: ± 0.05 ms	
Short ITH	Setting range: 0.24A - 250.00A / Resolution: 8.0mA	Setting range: 0.36A - 375.00A / Resolution: 12mA
OCP ISTAR	Setting range: 0.80A - 500.00A / Resolution: 8.0mA	Setting range: 1.20A - 750.00A / Resolution: 12mA
OCP TSTEP	Setting range: 0.05 - 10ms, 11 - 1000ms / Resolution: 1us, 1ms	Setting range: 0.05 - 10ms / Resolution: 1us
Meas. Accuracy	± 0.1 ms, ± 0.5 ms	± 0.5 ms
OCP ISTEP	Setting range: 0.00A - 500.00A / Resolution: 8.0mA	Setting range: 7.50A - 750.00A / Resolution: 12mA
OCP ISTOP	Setting range: 0.80A - 500.00A / Resolution: 8.0mA	Setting range: 1.20A - 750.00A / Resolution: 12mA
OCP ITH	Setting range: 0.24A - 250.00A / Resolution: 8.0mA	Setting range: 0.37A - 375.00A / Resolution: 12mA

Surge test

SUR.I	0 - 750A
NOR.I	0 - 375A
S.TIME	10 - 2000ms
S.STEP	1 - 5

SEQUENCE LOAD test

Discharge mode CC / CP

No. of setting steps 2 - 16

Step time range 20 - 100us / 2 - 65535ms / 66 - 999s

Resolution 10us / 1ms / 1s

Dynamic mode RANGE I RANGE II**Timing**

Thigh & Tlow 0.010 - 9.999 / 10.00 - 99.99 / 100.0 - 999.9 / 1000 - 9999ms

Resolution 0.001 / 0.01 / 0.1 / 1ms

Setting accuracy 1us / 10us / 100us / 1ms + 50ppm

Slew rate 0.0320 - 2.000A/us 0.3200 - 20.000A/us

Resolution 0.008A/us 0.08A/us

Min. Rise Time 25us (typical)

Setting accuracy \pm (5% of Setting + 10 μ s)**Current**

Setting range 0 - 50A 50 - 500A

Resolution 0.8mA 8mA

Conf key parameter

Load ON voltage Setting range: 0.25V - 62.50V / Resolution: 0.25V

Load OFF voltage Setting range: 0.000V - 62.250V / Resolution: 0.0025V

Average time 0 - 64

CV res. speed 1 - 4 (Fastest)

Measurement**Voltage Read Back**

Range (5 Digital) 0 - 15V 15 - 150V

Resolution 0.25mV 2.5mV

Meas. Accuracy \pm 0.025% of (Reading + Range)**Current Read Back**

Range (5 Digital) 0 - 50A 50 - 500A

Resolution 0.8mA 8mA

Meas. Accuracy \pm 0.05% of (Reading + Range)**Power Read Back**

Range (5 Digital) 5kW

Resolution 0.01W

Meas. Accuracy*4 \pm 0.06% of (Reading + Range)**General**

Remote Sensing Voltage that can be Compensated:
 Below the total rated voltage on both sides
 However, the V sense terminal voltage and DC input terminal voltage
 must be used within the operating range.

Resistance When V sense terminal is not used: 1.2M Ω typical
 when LOAD OFF When V sense terminal is used: 600k Ω typical

Short resistance 1.5m Ω typical

Max. Short Current	500A
Load ON Voltage	0.25 - 62.5V
Load OFF Voltage	0 - 62.25V
Weight	32.5kg

11-2-3. LSC602-151

Rating		
Power ^{*1}	0 - 6kW, Turbo mode: 0 - 9kW max. ^{*1}	
Current	0 - 600A, Turbo mode: 0 - 900A max. ^{*1}	
Voltage	0 - 150V	
Min. Operating Voltage	0.7V@600A	
Protections		
OPP	105%	
OCP	104%	
OVP	105%	
OTP	90°C ± 5°C	
CC mode	RANGE I	RANGE II
Range ^{*2} /Resolution	0 - 60A / 0.96mA	0 - 600A / 9.6mA
Accuracy ^{*3}	± 0.05% of (Setting + Range)	
CR mode	RANGE I	RANGE II
Range ^{*2} / Resolution	15kΩ - 0.25Ω / 66.7uS	0.25Ω - 0.0012Ω / 4.167uΩ
Accuracy	± (0.1% (Vin / Setting) + 0.1% I.F.S.)	± (0.2% (Vin / Setting) + 0.5% I.F.S.) ^{*9}
CV mode		
Range / Resolution	0 - 150V / 2.5mV	
Accuracy	± 0.05% of (Setting + Range)	
CP mode	RANGE I	RANGE II
Range ^{*2} / Resolution	0 - 600W / 9.6mW	600W - 6kW / 96mW
Accuracy ^{*4}	± 0.2% of (Setting + Range)	
CV + C limit mode		
Range / Resolution	150V / 2.5mV	600A / 9.6mA
Accuracy ^{*4}	± 0.05% of (Setting + Range)	± 1.0% of (Setting + Range)
CV + P limit mode		
Range / Resolution	150V / 2.5mV	6kW / 96mW
Accuracy ^{*4}	± 0.05% of (Setting + Range)	± 1.0% of (Setting + Range)
Short / OCP / OPP test		
Turbo mode ^{*5}	OFF	ON
Max. Current	600A	900A ^{*1}
Max. Power	6000W	9000W ^{*1}
Accuracy ^{*6}	± 1.0% of (Reading + Range)	

SHORT TIME	100 - 10000ms, Continuous	100 - 2000ms
	Resolution: 100ms / Setting accuracy: ± 5 ms	
Short V Hi	Setting range: 0.00V - 150.00V / Resolution: 0.0025V	
Short V Lo	Setting range: 0.00V - 150.00V / Resolution: 0.0025V	
OCP Time (Tstep)	100ms / Setting accuracy: ± 5 ms	20ms / Setting accuracy: ± 5 ms
OCP ISTAR/ ISTEP/ISTOP	Setting range: 0.00A - 600.00A Resolution: 9.60mA	Setting range: 0.00A - 900.00A Resolution: 14.4mA
OCP VTH	Setting range: 0.00V - 150.00V / Resolution: 0.0025V	
OPP Time (Tstep)	100ms / Setting accuracy: ± 5 ms	20ms / Setting accuracy: ± 5 ms
OPP PSTAR/ PSTEP/PSTOP	Setting range: 0.00W - 6000.0W Resolution: 96mW	Setting range: 0.00W - 9000.0W Resolution: 144mW
OPP VTH	Setting range: 0.00V - 150.00V / Resolution: 0.0025V	

Batt test

Batt CC	Setting range: 0.00A - 600.00A / Resolution: 9.6mA	
Batt CP	Setting range: 0.00A - 6000.0W / Resolution: 96mW	
STOP Voltage	Setting range: 0.00V - 150.00V / Resolution: 0.0025V	
STOP TIME	Setting range: OFF, 1 - 99999s / Resolution: 1s	
STOP CAP.AH	Setting range: OFF, 0.1 - 19999.9AH / Resolution: 0.1AH	
STOP CAP.WH	Setting range: OFF, 0.1 - 19999.9WH / Resolution: 0.1WH	

BMS test⁷

Turbo mode ⁵	OFF	ON
Max. Current	600A	900A
Meas. Accuracy ⁶	$\pm 3.0\%$ of (Reading + Range)	
Short test time	Setting range: 0.05 ~ 10ms / Resolution: 0.01ms	
Accuracy	Meas.: ± 0.02 ms / Setting: ± 0.05 ms	
Short ITH	Setting range: 0.28A - 300.00A / Resolution: 9.6mA	Setting range: 0.43A - 450.00A / Resolution: 14.4mA
OCP ISTAR	Setting range: 0.96A - 600.00A / Resolution: 9.6mA	Setting range: 1.44A - 900.00A / Resolution: 14.4mA
OCP TSTEP	Setting range: 0.05 - 10ms, 11 - 1000ms / Resolution: 1us, 1ms	Setting range: 0.05 - 10ms / Resolution: 1us
Meas. Accuracy	± 0.1 ms, ± 0.5 ms	± 0.5 ms
OCP ISTEP	Setting range: 0.00A - 600.00A / Resolution: 9.6mA	Setting range: 9.00A - 900.00A / Resolution: 14.4mA
OCP ISTOP	Setting range: 0.96A - 600.00A / Resolution: 9.6mA	Setting range: 1.44A - 900.00A / Resolution: 14.4mA
OCP ITH	Setting range: 0.29A - 300.00A / Resolution: 9.6mA	Setting range: 0.44A - 450.00A / Resolution: 14.4mA

Surge test

SUR.I	0 - 900A
NOR.I	0 - 450A
S.TIME	10 - 2000ms
S.STEP	1 - 5

SEQUENCE LOAD test

Discharge mode CC / CP

No. of setting steps 2 - 16

Step time range 20 - 100us / 2 - 65535ms / 66 - 999s

Resolution 10us / 1ms / 1s

Dynamic mode RANGE I RANGE II**Timing**

Thigh & Tlow 0.010 - 9.999 / 10.00 - 99.99 / 100.0 - 999.9 / 1000 - 9999ms

Resolution 0.001 / 0.01 / 0.1 / 1ms

Setting accuracy 1us / 10us / 100us / 1ms + 50ppm

Slew rate 0.0384 - 2.400A/us 0.3840 - 24.000A/us

Resolution 0.0096A/us 0.096A/us

Min. Rise Time 25us (typical)

Setting accuracy \pm (5% of Setting + 10 μ s)**Current**

Setting range 0 - 60A 60 - 600A

Resolution 0.96mA 9.6mA

Conf key parameter

Load ON voltage Setting range: 0.25V - 62.50V / Resolution: 0.25V

Load OFF voltage Setting range: 0.000V - 62.250V / Resolution: 0.0025V

Average time 0 - 64

CV res. speed 1 - 4 (Fastest)

Measurement**Voltage Read Back**

Range (5 Digital) 0 - 15V 15 - 150V

Resolution 0.25mV 2.5mV

Meas. Accuracy \pm 0.025% of (Reading + Range)**Current Read Back**

Range (5 Digital) 0 - 60A 60 - 600A

Resolution 0.96mA 9.6mA

Meas. Accuracy \pm 0.05% of (Reading + Range)**Power Read Back**

Range (5 Digital) 6kW

Resolution 0.01W

Meas. Accuracy*4 \pm 0.06% of (Reading + Range)**General**

Remote Sensing Voltage that can be Compensated:
 Below the total rated voltage on both sides
 However, the V sense terminal voltage and DC input terminal voltage
 must be used within the operating range.

Resistance When V sense terminal is not used: 1.2M Ω typical
 when LOAD OFF When V sense terminal is used: 600k Ω typical

Short resistance 1.2m Ω typical

Max. Short Current	600A
Load ON Voltage	0.25 - 62.5V
Load OFF Voltage	0 - 62.25V
Weight	32.5kg

11-2-4. LSC402-601

Rating

Power ^{*1}	0 - 4kW, Turbo mode: 0 - 6kW max. ^{*1}	
Current	0 - 280A, Turbo mode: 0 - 420A max. ^{*1}	
Voltage	0 - 600V	
Min. Operating Voltage	10V@280A	

Protections

OPP	105%
OCP	104%
OVP	105%
OTP	90°C ± 5°C

CC mode

	RANGE I	RANGE II
Range ^{*2} /Resolution	0 - 28A / 0.448mA	0 - 280A / 4.48mA
Accuracy ^{*3}	± 0.05% of (Setting + Range)	

CR mode

	RANGE I	RANGE II
Range ^{*2} / Resolution	128.61kΩ - 2.1435Ω / 7.775uS	2.1435Ω - 0.0357Ω / 35.73uΩ
Accuracy	± (0.1% (Vin / Setting) + 0.1% I.F.S.)	± (0.2% (Vin / Setting) + 0.5% I.F.S.)

CV mode

Range / Resolution	0 - 600V / 10mV
Accuracy	± 0.05% of (Setting + Range)

CP mode

	RANGE I	RANGE II
Range ^{*2} / Resolution	0 - 400W / 6.4mW	400W - 4kW / 64mW
Accuracy ^{*4}	± 0.2% of (Setting + Range)	

CV + C limit mode

Range / Resolution	600V / 10mV	280A / 4.48mA
Accuracy ^{*4}	± 0.05% of (Setting + Range)	± 1.0% of (Setting + Range)

CV + P limit mode

Range / Resolution	600V / 10mV	4kW / 64mW
Accuracy ^{*4}	± 0.05% of (Setting + Range)	± 1.0% of (Setting + Range)

Short / OCP / OPP test

Turbo mode ^{*5}	OFF	ON
Max. Current	280A	420A ^{*1}
Max. Power	4000W	6000W ^{*1}
Accuracy ^{*6}	± 1.0% of (Reading + Range)	

SHORT TIME	100 - 10000ms, Continuous	100 - 2000ms
	Resolution: 100ms / Setting accuracy: ± 5 ms	
Short V Hi	Setting range: 0.00V - 600.00V / Resolution: 0.01V	
Short V Lo	Setting range: 0.00V - 600.00V / Resolution: 0.01V	
OCP Time (Tstep)	100ms / Setting accuracy: ± 5 ms	20ms / Setting accuracy: ± 5 ms
OCP ISTAR/ ISTEP/ISTOP	Setting range: 0.00A - 280.00A Resolution: 4.48mA	Setting range: 0.00A - 420.00A Resolution: 6.72mA
OCP VTH	Setting range: 0.00V - 600.00V / Resolution: 0.01V	
OPP Time (Tstep)	100ms / Setting accuracy: ± 5 ms	20ms / Setting accuracy: ± 5 ms
OPP PSTAR/ PSTEP/PSTOP	Setting range: 0.00W - 4000.0W Resolution: 64.0mW	Setting range: 0.00W - 6000.0W Resolution: 96.0mW
OPP VTH	Setting range: 0.00V - 600.00V / Resolution: 0.01V	

Batt test

Batt CC	Setting range: 0.00A - 280.00A / Resolution: 4.48mA	
Batt CP	Setting range: 0.00A - 4000.0W / Resolution: 64.0mW	
STOP Voltage	Setting range: 0.00V - 600.00V / Resolution: 0.01V	
STOP TIME	Setting range: OFF, 1 - 99999s / Resolution: 1s	
STOP CAP.AH	Setting range: OFF, 0.1 - 19999.9AH / Resolution: 0.1AH	
STOP CAP.WH	Setting range: OFF, 0.1 - 19999.9WH / Resolution: 0.1WH	

BMS test⁷

Turbo mode ⁵	OFF	ON
Max. Current	280A	420A
Meas. Accuracy ⁶	$\pm 3.0\%$ of (Reading + Range)	
Short test time	Setting range: 0.05 ~ 10ms / Resolution: 0.01ms	
Accuracy	Meas.: ± 0.02 ms / Setting: ± 0.05 ms	
Short ITH	Setting range: 0.13A - 140.00A / Resolution: 4.48mA	Setting range: 0.20A - 210.00A / Resolution: 6.72mA
OCP ISTAR	Setting range: 0.44A - 280.00A / Resolution: 4.48mA	Setting range: 0.67A - 420.00A / Resolution: 6.72mA
OCP TSTEP	Setting range: 0.05 - 10ms, 11 - 1000ms / Resolution: 1us, 1ms	Setting range: 0.05 - 10ms / Resolution: 1us
Meas. Accuracy	± 0.1 ms, ± 0.5 ms	± 0.5 ms
OCP ISTEP	Setting range: 0.00A - 280.00A / Resolution: 4.48mA	Setting range: 4.20A - 420.00A / Resolution: 6.72mA
OCP ISTOP	Setting range: 0.44A - 280.00A / Resolution: 4.48mA	Setting range: 0.67A - 420.00A / Resolution: 6.72mA
OCP ITH	Setting range: 0.13A - 140.00A / Resolution: 4.48mA	Setting range: 0.20A - 210.00A / Resolution: 6.72mA

Surge test

SUR.I	0 - 420A
NOR.I	0 - 210A
S.TIME	10 - 2000ms
S.STEP	1 - 5

SEQUENCE LOAD test

Discharge mode CC / CP

No. of setting steps 2 - 16

Step time range 20 - 100us / 2 - 65535ms / 66 - 999s

Resolution 10us / 1ms / 1s

Dynamic mode RANGE I RANGE II

Timing

Thigh & Tlow 0.010 - 9.999 / 10.00 - 99.99 / 100.0 - 999.9 / 1000 - 9999ms

Resolution 0.001 / 0.01 / 0.1 / 1ms

Setting accuracy 1us / 10us / 100us / 1ms + 50ppm

Slew rate 0.01792 - 1.120A/us 0.1792 - 11.200A/us

Resolution 0.00448A/us 0.0448A/us

Min. Rise Time 25us (typical)

Setting accuracy \pm (5% of Setting + 10 μ s)

Current

Setting range 0 - 28A 28 - 280A

Resolution 0.45mA 4.48mA

Conf key parameter

Load ON voltage Setting range: 0.4V - 100.0V / Resolution: 0.4V

Load OFF voltage Setting range: 0.000V - 99.60V / Resolution: 0.01V

Average time 0 - 64

CV res. speed 1 - 4 (Fastest)

Measurement

Voltage Read Back

Range (5 Digital) 0 - 60V 60 - 600V

Resolution 1.00mV 10.0mV

Meas. Accuracy \pm 0.025% of (Reading + Range)

Current Read Back

Range (5 Digital) 0 - 28A 28 - 280A

Resolution 0.448mA 4.48mA

Meas. Accuracy \pm 0.05% of (Reading + Range)

Power Read Back

Range (5 Digital) 4kW

Resolution 0.01W

Meas. Accuracy*4 \pm 0.06% of (Reading + Range)

General

Remote Sensing Voltage that can be Compensated:
Below the total rated voltage on both sides
However, the V sense terminal voltage and DC input terminal voltage must be used within the operating range.

Resistance when LOAD OFF When V sense terminal is not used: 1.5M Ω typical
When V sense terminal is used: 750k Ω typical

Short resistance 35.73m Ω typical

Max. Short Current	280A
Load ON Voltage	0.4 - 100V
Load OFF Voltage	0 - 99.6V
Weight	32.5kg

11-2-5. LSC502-601

Rating		
Power ^{*1}	0 - 5kW, Turbo mode: 0 - 7.5kW max. ^{*1}	
Current	0 - 350A, Turbo mode: 0 - 525A max. ^{*1}	
Voltage	0 - 600V	
Min. Operating Voltage	10V@350A	
Protections		
OPP	105%	
OCP	104%	
OVP	105%	
OTP	90°C ± 5°C	
CC mode	RANGE I	RANGE II
Range ^{*2} /Resolution	0 - 35A / 0.56mA	0 - 350A / 5.6mA
Accuracy ^{*3}	± 0.05% of (Setting + Range)	
CR mode	RANGE I	RANGE II
Range ^{*2} / Resolution	102.888kΩ - 1.7148Ω / 9.719uS	1.7148Ω - 0.0285Ω / 28.584uΩ
Accuracy	± (0.1% (Vin / Setting) + 0.1% I F.S.)	± (0.2% (Vin / Setting) + 0.5% I F.S.)
CV mode		
Range / Resolution	0 - 600V / 10mV	
Accuracy	± 0.05% of (Setting + Range)	
CP mode	RANGE I	RANGE II
Range ^{*2} / Resolution	0 - 500W / 8mW	500W - 5kW / 80mW
Accuracy ^{*4}	± 0.2% of (Setting + Range)	
CV + C limit mode		
Range / Resolution	600V / 10mV	350A / 5.6mA
Accuracy ^{*4}	± 0.05% of (Setting + Range)	± 1.0% of (Setting + Range)
CV + P limit mode		
Range / Resolution	600V / 10mV	5kW / 80mW
Accuracy ^{*4}	± 0.05% of (Setting + Range)	± 1.0% of (Setting + Range)
Short / OCP / OPP test		
Turbo mode ^{*5}	OFF	ON
Max. Current	350A	525A ^{*1}
Max. Power	5000W	7500W ^{*1}
Accuracy ^{*6}	± 1.0% of (Reading + Range)	

SHORT TIME	100 - 10000ms, Continuous	100 - 2000ms
	Resolution: 100ms / Setting accuracy: ± 5 ms	
Short V Hi	Setting range: 0.00V - 600.00V / Resolution: 0.01V	
Short V Lo	Setting range: 0.00V - 600.00V / Resolution: 0.01V	
OCP Time (Tstep)	100ms / Setting accuracy: ± 5 ms	20ms / Setting accuracy: ± 5 ms
OCP ISTAR/ ISTEP/ISTOP	Setting range: 0.00A - 350.00A Resolution: 5.6mA	Setting range: 0.00A - 525.00A Resolution: 8.4mA
OCP VTH	Setting range: 0.00V - 600.00V / Resolution: 0.01V	
OPP Time (Tstep)	100ms / Setting accuracy: ± 5 ms	20ms / Setting accuracy: ± 5 ms
OPP PSTAR/ PSTEP/PSTOP	Setting range: 0.00W - 5000.0W Resolution: 80.0mW	Setting range: 0.00W - 7500.0W Resolution: 120mW
OPP VTH	Setting range: 0.00V - 600.00V / Resolution: 0.01V	

Batt test

Batt CC	Setting range: 0.00A - 350.00A / Resolution: 5.6mA	
Batt CP	Setting range: 0.00A - 5000.0W / Resolution: 80.0mW	
STOP Voltage	Setting range: 0.00V - 600.00V / Resolution: 0.01V	
STOP TIME	Setting range: OFF, 1 - 99999s / Resolution: 1s	
STOP CAP.AH	Setting range: OFF, 0.1 - 19999.9AH / Resolution: 0.1AH	
STOP CAP.WH	Setting range: OFF, 0.1 - 19999.9WH / Resolution: 0.1WH	

BMS test⁷

Turbo mode ⁵	OFF	ON
Max. Current	350A	525A
Meas. Accuracy ⁶	$\pm 3.0\%$ of (Reading + Range)	
Short test time	Setting range: 0.05 ~ 10ms / Resolution: 0.01ms	
Accuracy	Meas.: ± 0.02 ms / Setting: ± 0.05 ms	
Short ITH	Setting range: 0.16A - 175.00A / Resolution: 5.6mA	Setting range: 0.25A - 262.5A / Resolution: 8.4mA
OCP ISTAR	Setting range: 0.56A - 350.00A / Resolution: 5.6mA	Setting range: 0.84A - 525.00A / Resolution: 8.4mA
OCP TSTEP	Setting range: 0.05 - 10ms, 11 - 1000ms / Resolution: 1us, 1ms	Setting range: 0.05 - 10ms / Resolution: 1us
Meas. Accuracy	± 0.1 ms, ± 0.5 ms	± 0.5 ms
OCP ISTEP	Setting range: 0.00A - 350.00A / Resolution: 5.6mA	Setting range: 5.25A - 525.00A / Resolution: 8.4mA
OCP ISTOP	Setting range: 0.56A - 350.00A / Resolution: 5.6mA	Setting range: 0.84A - 525.00A / Resolution: 8.4mA
OCP ITH	Setting range: 0.17A - 175.00A / Resolution: 5.6mA	Setting range: 0.26A - 262.5A / Resolution: 8.4mA

Surge test

SUR.I	0 - 525A
NOR.I	0 - 262.5A
S.TIME	10 - 2000ms
S.STEP	1 - 5

SEQUENCE LOAD test

Discharge mode CC / CP

No. of setting steps 2 - 16

Step time range 20 - 100us / 2 - 65535ms / 66 - 999s

Resolution 10us / 1ms / 1s

Dynamic mode RANGE I RANGE II

Timing

Thigh & Tlow 0.010 - 9.999 / 10.00 - 99.99 / 100.0 - 999.9 / 1000 - 9999ms

Resolution 0.001 / 0.01 / 0.1 / 1ms

Setting accuracy 1us / 10us / 100us / 1ms + 50ppm

Slew rate 0.0244 - 1.400A/us 0.2440 - 14.00A/us

Resolution 0.0056A/us 0.056A/us

Min. Rise Time 25us (typical)

Setting accuracy \pm (5% of Setting + 10 μ s)

Current

Setting range 0 - 35A 35 - 350A

Resolution 0.56mA 5.6mA

Conf key parameter

Load ON voltage Setting range: 0.4V - 100.0V / Resolution: 0.4V

Load OFF voltage Setting range: 0.000V - 96.60V / Resolution: 0.01V

Average time 0 - 64

CV res. speed 1 - 4 (Fastest)

Measurement

Voltage Read Back

Range (5 Digital) 0 - 60V 60 - 600V

Resolution 1.0mV 10.0mV

Meas. Accuracy \pm 0.025% of (Reading + Range)

Current Read Back

Range (5 Digital) 0 - 35A 35 - 350A

Resolution 0.56mA 5.6mA

Meas. Accuracy \pm 0.05% of (Reading + Range)

Power Read Back

Range (5 Digital) 5kW

Resolution 0.01W

Meas. Accuracy*4 \pm 0.06% of (Reading + Range)

General

Remote Sensing Voltage that can be Compensated:
Below the total rated voltage on both sides
However, the V sense terminal voltage and DC input terminal voltage
must be used within the operating range.

Resistance When V sense terminal is not used: 1.5M Ω typical
When V sense terminal is used: 750k Ω typical

Short resistance 28.584m Ω typical

Max. Short Current	350A
Load ON Voltage	0.4 - 100V
Load OFF Voltage	0 – 99.60V
Weight	33.0kg

11-2-6. LSC602-601

Rating

Power ^{*1}	0 - 6kW, Turbo mode: 0 - 9kW max. ^{*1}	
Current	0 - 420A, Turbo mode: 0 - 630A max. ^{*1}	
Voltage	0 - 600V	
Min. Operating Voltage	10V@420A	

Protections

OPP	105%
OCP	104%
OVP	105%
OTP	90°C ± 5°C

CC mode

	RANGE I	RANGE II
Range ^{*2} /Resolution	0 - 42A / 0.672mA	0 - 420A / 6.72mA
Accuracy ^{*3}	± 0.05% of (Setting + Range)	

CR mode

	RANGE I	RANGE II
Range ^{*2} / Resolution	85.74kΩ - 1.429Ω / 11.66uS	1.429Ω - 0.0238Ω / 23.82uΩ
Accuracy	± (0.1% (Vin / Setting) + 0.1% I.F.S.)	± (0.2% (Vin / Setting) + 0.5% I.F.S.)

CV mode

Range / Resolution	0 - 600V / 10mV
Accuracy	± 0.05% of (Setting + Range)

CP mode

	RANGE I	RANGE II
Range ^{*2} / Resolution	0 - 600W / 9.6mW	600W - 6kW / 96mW
Accuracy ^{*4}	± 0.2% of (Setting + Range)	

CV + C limit mode

Range / Resolution	600V / 10mV	420A / 6.72mA
Accuracy ^{*4}	± 0.05% of (Setting + Range)	± 1.0% of (Setting + Range)

CV + P limit mode

Range / Resolution	600V / 10mV	6kW / 96mW
Accuracy ^{*4}	± 0.05% of (Setting + Range)	± 1.0% of (Setting + Range)

Short / OCP / OPP test

Turbo mode ^{*5}	OFF	ON
Max. Current	420A	630A ^{*1}
Max. Power	6000W	9000W ^{*1}
Accuracy ^{*6}	± 1.0% of (Reading + Range)	

SHORT TIME	100 - 10000ms, Continuous	100 - 2000ms
	Resolution: 100ms / Setting accuracy: ± 5 ms	
Short V Hi	Setting range: 0.00V - 600.00V / Resolution: 0.01V	
Short V Lo	Setting range: 0.00V - 600.00V / Resolution: 0.01V	
OCP Time (Tstep)	100ms / Setting accuracy: ± 5 ms	20ms / Setting accuracy: ± 5 ms
OCP ISTAR/ ISTEP/ISTOP	Setting range: 0.00A - 420.00A Resolution: 6.72mA	Setting range: 0.00A - 630.00A Resolution: 10.08mA
OCP VTH	Setting range: 0.00V - 600.00V / Resolution: 0.01V	
OPP Time (Tstep)	100ms / Setting accuracy: ± 5 ms	20ms / Setting accuracy: ± 5 ms
OPP PSTAR/ PSTEP/PSTOP	Setting range: 0.00W - 6000.0W Resolution: 96mW	Setting range: 0.00W - 9000.0W Resolution: 144mW
OPP VTH	Setting range: 0.00V - 600.00V / Resolution: 0.01V	

Batt test

Batt CC	Setting range: 0.00A - 420.00A / Resolution: 6.72mA	
Batt CP	Setting range: 0.00A - 6000.0W / Resolution: 96mW	
STOP Voltage	Setting range: 0.00V - 600.00V / Resolution: 0.01V	
STOP TIME	Setting range: OFF, 1 - 99999s / Resolution: 1s	
STOP CAP.AH	Setting range: OFF, 0.1 - 19999.9AH / Resolution: 0.1AH	
STOP CAP.WH	Setting range: OFF, 0.1 - 19999.9WH / Resolution: 0.1WH	

BMS test⁷

Turbo mode ⁵	OFF	ON
Max. Current	420A	630A
Meas. Accuracy ⁶	$\pm 3.0\%$ of (Reading + Range)	
Short test time	Setting range: 0.05 ~ 10ms / Resolution: 0.01ms	
Accuracy	Meas.: ± 0.02 ms / Setting: ± 0.05 ms	
Short ITH	Setting range: 0.20A - 210.0A / Resolution: 6.72mA	Setting range: 0.30A - 315.0A / Resolution: 10.08mA
OCP ISTAR	Setting range: 0.67A - 420.00A / Resolution: 6.72mA	Setting range: 1.00A - 630.00A / Resolution: 10.08mA
OCP TSTEP	Setting range: 0.05 - 10ms, 11 - 1000ms / Resolution: 1us, 1ms	Setting range: 0.05 - 10ms / Resolution: 1us
Meas. Accuracy	± 0.1 ms, ± 0.5 ms	± 0.5 ms
OCP ISTEP	Setting range: 0.00A - 420.00A / Resolution: 6.72mA	Setting range: 6.30A - 630.00A / Resolution: 10.08mA
OCP ISTOP	Setting range: 0.67A - 420.00A / Resolution: 6.72mA	Setting range: 1.00A - 630.00A / Resolution: 10.08mA
OCP ITH	Setting range: 0.20A - 210.00A / Resolution: 6.72mA	Setting range: 0.30A - 315.00A / Resolution: 10.08mA

Surge test

SUR.I	0 - 630A
NOR.I	0 - 315A
S.TIME	10 - 2000ms
S.STEP	1 - 5

SEQUENCE LOAD test

Discharge mode CC / CP

No. of setting steps 2 - 16

Step time range 20 - 100us / 2 - 65535ms / 66 - 999s

Resolution 10us / 1ms / 1s

Dynamic mode RANGE I RANGE II**Timing**

Thigh & Tlow 0.010 - 9.999 / 10.00 - 99.99 / 100.0 - 999.9 / 1000 - 9999ms

Resolution 0.001 / 0.01 / 0.1 / 1ms

Setting accuracy 1us / 10us / 100us / 1ms + 50ppm

Slew rate 0.02688 - 1.680A/us 0.2688 - 16.800A/us

Resolution 0.00672A/us 0.0672A/us

Min. Rise Time 25us (typical)

Setting accuracy \pm (5% of Setting + 10 μ s)**Current**

Setting range 0 - 42A 42 - 420A

Resolution 0.67mA 6.72mA

Conf key parameter

Load ON voltage Setting range: 0.4V - 100.0V / Resolution: 0.4V

Load OFF voltage Setting range: 0.000V - 99.60V / Resolution: 0.01V

Average time 0 - 64

CV res. speed 1 - 4 (Fastest)

Measurement**Voltage Read Back**

Range (5 Digital) 0 - 60V 60 - 600V

Resolution 1.00mV 10.0mV

Meas. Accuracy \pm 0.025% of (Reading + Range)**Current Read Back**

Range (5 Digital) 0 - 42A 42 - 420A

Resolution 0.672mA 6.72mA

Meas. Accuracy \pm 0.05% of (Reading + Range)**Power Read Back**

Range (5 Digital) 6kW

Resolution 0.01W

Meas. Accuracy*4 \pm 0.06% of (Reading + Range)**Genera**

Remote Sensing Voltage that can be Compensated:
 Below the total rated voltage on both sides
 However, the V sense terminal voltage and DC input terminal voltage
 must be used within the operating range.

Resistance when LOAD OFF When V sense terminal is not used: 1.5M Ω typical
 When V sense terminal is used: 750k Ω typical

Short resistance 23.82m Ω typical

Max. Short Current	420A
Load ON Voltage	0.4 - 100V
Load OFF Voltage	0 – 99.60V
Weight	33.0kg

11-2-7. LSC402-122

Rating		
Power ^{*1}	0 - 4kW, Turbo mode: 0 - 6kW max. ^{*1}	
Current	0 - 160A, Turbo mode: 0 - 240A max. ^{*1}	
Voltage	0 - 1200V	
Min. Operating Voltage	15V@160A	
Protections		
OPP	105%	
OCP	104%	
OVP	105%	
OTP	90°C ± 5°C	
CC mode	RANGE I	RANGE II
Range ^{*2} /Resolution	0 - 16A / 0.256mA	0 - 160A / 2.56mA
Accuracy ^{*3}	± 0.05% of (Setting + Range)	
CR mode	RANGE I	RANGE II
Range ^{*2} / Resolution	450kΩ - 7.5Ω / 2.22uS	7.5Ω - 0.0937Ω / 125uS
Accuracy	± (0.1% (Vin / Setting) + 0.1% I.F.S.)	± (0.2% (Vin / Setting) + 0.5% I.F.S.)
CV mode		
Range / Resolution	0 - 1200V / 20mV	
Accuracy	± 0.05% of (Setting + Range)	
CP mode	RANGE I	RANGE II
Range ^{*2} / Resolution	0 - 400W / 6.4mW	400W - 4kW / 64mW
Accuracy ^{*4}	± 0.2% of (Setting + Range)	
CV + C limit mode		
範圍 / 分解能	1200V / 20mV	160A / 2.56mA
確度 ^{*4}	± 0.05% of (Setting + Range)	± 1.0% of (Setting + Range)
CV + P limit mode		
範圍 / 分解能	1200V / 20mV	4kW / 64mW
確度 ^{*4}	± 0.05% of (Setting + Range)	± 1.0% of (Setting + Range)
Short / OCP / OPP test		
Turbo mode ^{*5}	OFF	ON
Max. Current	160A	240A ^{*1}
Max. Power	4000W	6000W ^{*1}
Accuracy ^{*6}	± 1.0% of (Reading + Range)	

SHORT TIME	100 - 10000ms, Continuous	100 - 2000ms
	Resolution: 100ms / Setting accuracy: ± 5 ms	
Short V Hi	Setting range: 0.25V - 1200.00V / Resolution: 0.02V	
Short V Lo	Setting range: 0.00V - 1200.00V / Resolution: 0.02V	
OCP Time (Tstep)	100ms / Setting accuracy: ± 5 ms	20ms / Setting accuracy: ± 5 ms
OCP ISTAR/ ISTEP/ISTOP	Setting range: 0.00A - 160.00A Resolution: 2.56mA	Setting range: 0.00A - 240.00A Resolution: 3.83mA
OCP VTH	Setting range: 0.00V - 1200.00V / Resolution: 0.02V	
OPP Time (Tstep)	100ms / Setting accuracy: ± 5 ms	20ms / Setting accuracy: ± 5 ms
OPP PSTAR/ PSTEP/PSTOP	Setting range: 0.00W - 4000.0W Resolution: 64.0mW	Setting range: 0.00W - 6000.0W Resolution: 96.0mW
OPP VTH	Setting range: 0.00V - 1200.00V / Resolution: 0.02V	
Batt test		
Batt CC	Setting range: 0.00A - 160.00A / Resolution: 2.56mA	
Batt CP	Setting range: 0.00A - 4000.0W / Resolution: 64.0mW	
STOP Voltage	Setting range: 0.00V - 1200.00V / Resolution: 0.02V	
STOP TIME	Setting range: OFF, 1 - 99999s / Resolution: 1s	
STOP CAP.AH	Setting range: OFF, 0.1 - 19999.9AH / Resolution: 0.1AH	
STOP CAP.WH	Setting range: OFF, 0.1 - 19999.9WH / Resolution: 0.1WH	
BMS test⁷		
Turbo mode ⁵	OFF	ON
Max. Current	160A	240A
Meas. Accuracy ⁶	$\pm 3.0\%$ of (Reading + Range)	
Short test time	Setting range: 0.05 ~ 10ms / Resolution: 0.01ms	
Accuracy	Meas.: ± 0.02 ms / Setting: ± 0.05 ms	
Short ITH	Setting range: 0.07A - 80.00A / Resolution: 2.56mA	Setting range: 0.11A - 120.00A / Resolution: 3.84mA
OCP ISTAR	Setting range: 0.25A - 160.00A / Resolution: 2.56mA	Setting range: 0.38A - 240.00A / Resolution: 3.84mA
OCP TSTEP	Setting range: 0.05 - 10ms, 11 - 1000ms / Resolution: 1us, 1ms	Setting range: 0.05 - 10ms / Resolution: 1us
Meas. Accuracy	± 0.1 ms, ± 0.5 ms	± 0.5 ms
OCP ISTEP	Setting range: 0.00A - 160.00A / Resolution: 2.56mA	Setting range: 2.40A - 240.00A / Resolution: 3.84mA
OCP ISTOP	Setting range: 0.25A - 160.00A / Resolution: 2.56mA	Setting range: 0.38A - 240.00A / Resolution: 3.84mA
OCP ITH	Setting range: 0.10A - 80.00A / Resolution: 2.56mA	Setting range: 0.15A - 120.00A / Resolution: 3.84mA
Surge test		
SUR.I	0 - 240A	
NOR.I	0 - 120A	
S.TIME	10 - 2000ms	
S.STEP	1 - 5	

SEQUENCE LOAD test

Discharge mode CC / CP

No. of setting steps 2 - 16

Step time range 20 - 100us / 2 - 65535ms / 66 - 999s

Resolution 10us / 1ms / 1s

Dynamic mode RANGE I RANGE II**Timing**

Thigh & Tlow 0.010 - 9.999 / 10.00 - 99.99 / 100.0 - 999.9 / 1000 - 9999ms

Resolution 0.001 / 0.01 / 0.1 / 1ms

Setting accuracy 1us / 10us / 100us / 1ms + 50ppm

Slew rate 0.01024 - 0.640A/us 0.1024 - 6.400A/us

Resolution 0.00256A/us 0.0256A/us

Min. Rise Time 25us (typical)

Setting accuracy \pm (5% of Setting + 10 μ s)**Current**

Setting range 0 - 16A 16 - 160A

Resolution 0.26mA 2.56mA

Conf key parameter

Load ON voltage Setting range: 0.1V – 250.0V / Resolution: 1.0V

Load OFF voltage Setting range: 0.000V – 249.0V / Resolution: 0.02V

Average time 0 - 64

CV res. speed 1 - 4 (Fastest)

Measurement**Voltage Read Back**

Range (5 Digital) 0 - 120V 120 - 1200V

Resolution 2.00mV 20.0mV

Meas. Accuracy \pm 0.025% of (Reading + Range)**Current Read Back**

Range (5 Digital) 0 - 16A 16 - 160A

Resolution 0.256mA 2.56mA

Meas. Accuracy \pm 0.05% of (Reading + Range)**Power Read Back**

Range (5 Digital) 4kW

Resolution 0.01W

Meas. Accuracy*4 \pm 0.06% of (Reading + Range)**General**

Remote Sensing Voltage that can be Compensated:
 Below the total rated voltage on both sides
 However, the V sense terminal voltage and DC input terminal voltage
 must be used within the operating range.

Resistance when LOAD OFF When V sense terminal is not used: 3.6M Ω typical
 When V sense terminal is used: 1.8M Ω typical

Short resistance 93.75m Ω typical

Max. Short Current	160A
Load ON Voltage	1 - 250V
Load OFF Voltage	0 – 250V
Weight	32.0kg

11-2-8. LSC502-122

Rating

Power ^{*1}	0 - 5kW, Turbo mode: 0 - 7.5kW max. ^{*1}	
Current	0 - 200A, Turbo mode: 0 - 300A max. ^{*1}	
Voltage	0 - 1200V	
Min. Operating Voltage	15V@200A	

Protections

OPP	105%
OCP	104%
OVP	105%
OTP	90°C ± 5°C

CC mode

	RANGE I	RANGE II
Range ^{*2} /Resolution	0 - 20A / 0.32mA	0 - 200A / 3.2mA
Accuracy ^{*3}	± 0.05% of (Setting + Range)	

CR mode

	RANGE I	RANGE II
Range ^{*2} / Resolution	360kΩ - 6Ω / 2.78uS	6Ω - 0.075Ω / 100uΩ
Accuracy	± (0.1% (Vin / Setting) + 0.1% I.F.S.)	± (0.2% (Vin / Setting) + 0.5% I.F.S.)

CV mode

Range / Resolution	0 - 1200V / 20mV
Accuracy	± 0.05% of (Setting + Range)

CP mode

	RANGE I	RANGE II
Range ^{*2} / Resolution	0 - 500W / 8mW	500W - 5kW / 80mW
Accuracy ^{*4}	± 0.2% of (Setting + Range)	

CV + C limit mode

Range / Resolution	1200V / 20mV	200A / 3.2mA
Accuracy ^{*4}	± 0.05% of (Setting + Range)	± 1.0% of (Setting + Range)

CV + P limit mode

Range / Resolution	1200V / 20mV	5kW / 80mW
Accuracy ^{*4}	± 0.05% of (Setting + Range)	± 1.0% of (Setting + Range)

Short / OCP / OPP test

Turbo mode ^{*5}	OFF	ON
Max. Current	200A	300A ^{*1}
Max. Power	5000W	7500W ^{*1}
Accuracy ^{*6}	± 1.0% of (Reading + Range)	

SHORT TIME	100 - 10000ms, Continuous	100 - 2000ms
	Resolution: 100ms / Setting accuracy: ± 5 ms	
Short V Hi	Setting range: 0.25V - 1200.00V / Resolution: 0.02V	
Short V Lo	Setting range: 0.00V - 1200.00V / Resolution: 0.02V	
OCP Time (Tstep)	100ms / Setting accuracy: ± 5 ms	20ms / Setting accuracy: ± 5 ms
OCP ISTAR/ ISTEP/ISTOP	Setting range: 0.00A - 200.00A Resolution: 3.2mA	Setting range: 0.00A - 300.00A Resolution: 4.8mA
OCP VTH	Setting range: 0.00V - 1200.00V / Resolution: 0.02V	
OPP Time (Tstep)	100ms / Setting accuracy: ± 5 ms	20ms / Setting accuracy: ± 5 ms
OPP PSTAR/ PSTEP/PSTOP	Setting range: 0.00W - 5000.0W Resolution: 80.0mW	Setting range: 0.00W - 7500.0W Resolution: 120mW
OPP VTH	Setting range: 0.00V - 1200.00V / Resolution: 0.02V	

Batt test

Batt CC	Setting range: 0.00A - 200.00A / Resolution: 3.2mA	
Batt CP	Setting range: 0.00A - 5000.0W / Resolution: 80.0mW	
STOP Voltage	Setting range: 0.00V - 1200.00V / Resolution: 0.02V	
STOP TIME	Setting range: OFF, 1 - 99999s / Resolution: 1s	
STOP CAP.AH	Setting range: OFF, 0.1 - 19999.9AH / Resolution: 0.1AH	
STOP CAP.WH	Setting range: OFF, 0.1 - 19999.9WH / Resolution: 0.1WH	

BMS test⁷

Turbo mode ⁵	OFF	ON
Max. Current	200A	300A
Meas. Accuracy ⁶	$\pm 3.0\%$ of (Reading + Range)	
Short test time	Setting range: 0.05 ~ 10ms / Resolution: 0.01ms	
Accuracy	Meas.: ± 0.02 ms / Setting: ± 0.05 ms	
Short ITH	Setting range: 0.09A - 100.00A / Resolution: 3.2mA	Setting range: 0.14A - 150.00A / Resolution: 4.8mA
OCP ISTAR	Setting range: 0.32A - 200.00A / Resolution: 3.2mA	Setting range: 0.48A - 300.00A / Resolution: 4.8mA
OCP TSTEP	Setting range: 0.05 - 10ms, 11 - 1000ms / Resolution: 1us, 1ms	Setting range: 0.05 - 10ms / Resolution: 1us
Meas. Accuracy	± 0.1 ms, ± 0.5 ms	± 0.5 ms
OCP ISTEP	Setting range: 0.00A - 200.00A / Resolution: 3.2mA	Setting range: 3.00A - 300.00A / Resolution: 4.8mA
OCP ISTOP	Setting range: 0.32A - 200.00A / Resolution: 3.2mA	Setting range: 0.48A - 300.00A / Resolution: 4.8mA
OCP ITH	Setting range: 0.10A - 100.00A / Resolution: 3.2mA	Setting range: 0.15A - 150.00A / Resolution: 4.8mA

Surge test

SUR.I	0 - 300A
NOR.I	0 - 150A
S.TIME	10 - 2000ms
S.STEP	1 - 5

SEQUENCE LOAD test

Discharge mode CC / CP

No. of setting steps 2 - 16

Step time range 20 - 100us / 2 - 65535ms / 66 - 999s

Resolution 10us / 1ms / 1s

Dynamic mode	RANGE I	RANGE II
--------------	---------	----------

Timing

Thigh & Tlow 0.010 - 9.999 / 10.00 - 99.99 / 100.0 - 999.9 / 1000 - 9999ms

Resolution 0.001 / 0.01 / 0.1 / 1ms

Setting accuracy 1us / 10us / 100us / 1ms + 50ppm

Slew rate 0.0128 – 0.800A/us 0.1280 - 8.000A/us

Resolution 0.0032A/us 0.032A/us

Min. Rise Time 25us (typical)

Setting accuracy ± (5% of Setting + 10μs)

Current

Setting range 0 - 20A 20 - 200A

Resolution 0.32mA 3.2mA

Conf key parameter

Load ON voltage Setting range: 1V - 250.0V / Resolution: 1V

Load OFF voltage Setting range: 0.000V - 249.0V / Resolution: 0.02V

Average time 0 - 64

CV res. speed 1 - 4 (Fastest)

Measurement

Voltage Read Back

Range (5 Digital) 0 - 120V 120 - 1200V

Resolution 2.0mV 20.0mV

Meas. Accuracy ± 0.025% of (Reading + Range)

Current Read Back

Range (5 Digital) 0 - 20A 20 - 200A

Resolution 0.32mA 3.2mA

Meas. Accuracy ± 0.05% of (Reading + Range)

Power Read Back

Range (5 Digital) 5kW

Resolution 0.01W

Meas. Accuracy*4 ± 0.06% of (Reading + Range)

General

Remote Sensing Voltage that can be Compensated:
Below the total rated voltage on both sides
However, the V sense terminal voltage and DC input terminal voltage
must be used within the operating range.

Resistance When V sense terminal is not used: 3.6MΩ typical
when LOAD OFF When V sense terminal is used: 1.8MΩ typical

Short resistance 75mΩ typical

Max. Short Current	200A
Load ON Voltage	1 - 250V
Load OFF Voltage	0 – 250V
Weight	32.5kg

11-2-9. LSC602-122

Rating		
Power ^{*1}	0 - 6kW, Turbo mode: 0 - 9kW max. ^{*1}	
Current	0 - 240A, Turbo mode: 0 - 360A max. ^{*1}	
Voltage	0 - 1200V	
Min. Operating Voltage	15V@240A	
Protections		
OPP	105%	
OCP	104%	
OVP	105%	
OTP	90°C ± 5°C	
CC mode	RANGE I	RANGE II
Range ^{*2} /Resolution	0 - 24A / 0.384mA	0 - 240A / 3.84mA
Accuracy ^{*3}	± 0.05% of (Setting + Range)	
CR mode	RANGE I	RANGE II
Range ^{*2} / Resolution	300kΩ - 5Ω / 3.33uS	5Ω - 0.0625Ω / 83.34uΩ
Accuracy	± (0.1% (Vin / Setting) + 0.1% I.F.S.)	± (0.2% (Vin / Setting) + 0.5% I.F.S.)
CV mode		
Range / Resolution	0 - 1200V / 20mV	
Accuracy	± 0.05% of (Setting + Range)	
CP mode	RANGE I	RANGE II
Range ^{*2} / Resolution	0 - 600W / 9.6mW	600W - 6kW / 96mW
Accuracy ^{*4}	± 0.2% of (Setting + Range)	
CV + C limit mode		
範圍 / 分解能	1200V / 20mV	240A / 3.84mA
確度 ^{*4}	± 0.05% of (Setting + Range)	± 1.0% of (Setting + Range)
CV + P limit mode		
範圍 / 分解能	1200V / 20mV	6kW / 96mW
確度 ^{*4}	± 0.05% of (Setting + Range)	± 1.0% of (Setting + Range)
Short / OCP / OPP test		
Turbo mode ^{*5}	OFF	ON
Max. Current	240A	360A ^{*1}
Max. Power	6000W	9000W ^{*1}
Accuracy ^{*6}	± 1.0% of (Reading + Range)	

SHORT TIME	100 - 10000ms, Continuous	100 - 2000ms
	Resolution: 100ms / Setting accuracy: ± 5 ms	
Short V Hi	Setting range: 0.25V - 1200.00V / Resolution: 0.02V	
Short V Lo	Setting range: 0.00V - 1200.00V / Resolution: 0.02V	
OCP Time (Tstep)	100ms / Setting accuracy: ± 5 ms	20ms / Setting accuracy: ± 5 ms
OCP ISTAR/ ISTEP/ISTOP	Setting range: 0.00A - 240.00A Resolution: 3.84mA	Setting range: 0.00A - 360.00A Resolution: 5.76mA
OCP VTH	Setting range: 0.00V - 600.00V / Resolution: 0.01V	
OPP Time (Tstep)	100ms / Setting accuracy: ± 5 ms	20ms / Setting accuracy: ± 5 ms
OPP PSTAR/ PSTEP/PSTOP	Setting range: 0.00W - 6000.0W Resolution: 96mW	Setting range: 0.00W - 9000.0W Resolution: 144mW
OPP VTH	Setting range: 0.00V - 1200.00V / Resolution: 0.02V	
Batt test		
Batt CC	Setting range: 0.00A - 240.00A / Resolution: 3.84mA	
Batt CP	Setting range: 0.00A - 6000.0W / Resolution: 96mW	
STOP Voltage	Setting range: 0.00V - 1200.00V / Resolution: 0.02V	
STOP TIME	Setting range: OFF, 1 - 99999s / Resolution: 1s	
STOP CAP.AH	Setting range: OFF, 0.1 - 19999.9AH / Resolution: 0.1AH	
STOP CAP.WH	Setting range: OFF, 0.1 - 19999.9WH / Resolution: 0.1WH	
BMS test⁷		
Turbo mode ⁵	OFF	ON
Max. Current	240A	360A
Meas. Accuracy ⁶	$\pm 3.0\%$ of (Reading + Range)	
Short test time	Setting range: 0.05 ~ 10ms / Resolution: 0.01ms	
Accuracy	Meas.: ± 0.02 ms / Setting: ± 0.05 ms	
Short ITH	Setting range: 0.11A - 120.00A / Resolution: 3.84mA	Setting range: 0.17A - 180.00A / Resolution: 5.76mA
OCP ISTAR	Setting range: 0.38A - 240.00A / Resolution: 3.84mA	Setting range: 0.57A - 360.00A / Resolution: 5.76mA
OCP TSTEP	Setting range: 0.05 - 10ms, 11 - 1000ms / Resolution: 1us, 1ms	Setting range: 0.05 - 10ms / Resolution: 1us
Meas. Accuracy	± 0.1 ms, ± 0.5 ms	± 0.5 ms
OCP ISTEP	Setting range: 0.00A - 240.00A / Resolution: 3.84mA	Setting range: 3.60A - 360.00A / Resolution: 5.76mA
OCP ISTOP	Setting range: 0.38A - 240.00A / Resolution: 3.84mA	Setting range: 0.57A - 630.00A / Resolution: 5.76mA
OCP ITH	Setting range: 0.10A - 120.00A / Resolution: 3.84mA	Setting range: 0.15A - 180.00A / Resolution: 5.76mA
Surge test		
SUR.I	0 - 360A	
NOR.I	0 - 180A	
S.TIME	10 - 2000ms	
S.STEP	1 - 5	

SEQUENCE LOAD test

Discharge mode CC / CP

No. of setting steps 2 - 16

Step time range 20 - 100us / 2 - 65535ms / 66 - 999s

Resolution 10us / 1ms / 1s

Dynamic mode RANGE I RANGE II**Timing**

Thigh & Tlow 0.010 - 9.999 / 10.00 - 99.99 / 100.0 - 999.9 / 1000 - 9999ms

Resolution 0.001 / 0.01 / 0.1 / 1ms

Setting accuracy 1us / 10us / 100us / 1ms + 50ppm

Slew rate 0.01536 - 0.960A/us 0.1536 - 9.600A/us

Resolution 0.00384A/us 0.0384A/us

Min. Rise Time 25us (typical)

Setting accuracy \pm (5% of Setting + 10 μ s)**Current**

Setting range 0 - 24A 24 - 240A

Resolution 0.384mA 3.84mA

Conf key parameter

Load ON voltage Setting range: 1V - 250.0V / Resolution: 1V

Load OFF voltage Setting range: 0.000V - 249.0V / Resolution: 0.02V

Average time 0 - 64

CV res. speed 1 - 4 (Fastest)

Measurement**Voltage Read Back**

Range (5 Digital) 0 - 120V 120 - 1200V

Resolution 2.00mV 20.0mV

Meas. Accuracy \pm 0.025% of (Reading + Range)**Current Read Back**

Range (5 Digital) 0 - 24A 24 - 240A

Resolution 0.384mA 3.84mA

Meas. Accuracy \pm 0.05% of (Reading + Range)**Power Read Back**

Range (5 Digital) 6kW

Resolution 0.01W

Meas. Accuracy*4 \pm 0.06% of (Reading + Range)**General**

Remote Sensing Voltage that can be Compensated:
 Below the total rated voltage on both sides
 However, the V sense terminal voltage and DC input terminal voltage
 must be used within the operating range.

Resistance when LOAD OFF When V sense terminal is not used: 3.6M Ω typical
 When V sense terminal is used: 1.8M Ω typical

Short resistance 62.505m Ω typical

Max. Short Current	240A
Load ON Voltage	1 - 250V
Load OFF Voltage	0 – 250V
Weight	32.5kg

11-2-10. Common

General

Input rating	100Vac - 240Vac \pm 10%
Input frequency	50/60Hz \pm 3Hz
Power Consumption	550VA
Dimension (HxWxD)	177mmx440mmx741mm
Operating temp.* ⁸	0 - 40°C
Operating humidity	0 - 85%
Operating altitude	Altitude below 2000m
Storage temp.	-20 - 70°C
Storage humidity	Less than 90%
Environment	Indoor, Altitude < 2000m, Overvoltage category II
LVD	EN61010-1(Class1,Pollution 2),2014/35/EU Conformity
EMC	EN61326-1 (Class A), 2014/30/EU Conformity

- *1. The power rating specifications at ambient temperature = 25°C
- *2. The range is automatically or forcing to range II only in CC mode. The other mode is AUTO.
- *3. If the operating current is below range 0.1%, the accuracy specification is 0.1% F.S.
- *4. Power range = V range x I range
- *5. Turbo mode for up to 1.5X Current rating & Power rating support BMS, Short/OCP/OPP test function
- *6. The best accuracy of OCP/OPP test is I Step/P Step=1%FS
- *7. BMS test function for SHORT, OCPP, OCPD test for BMS board evaluation
- *8. Operating temperature range is 0~40°C, all specifications apply for 25°C \pm 5°C, except as noted
- *9. DC input terminal voltage > 1.5V
Resistance setting > 3.7m Ω (LSC402-151), 3m Ω (LSC502-151),
2.5m Ω (LSC602-151)

11-3. LSC series dimensions

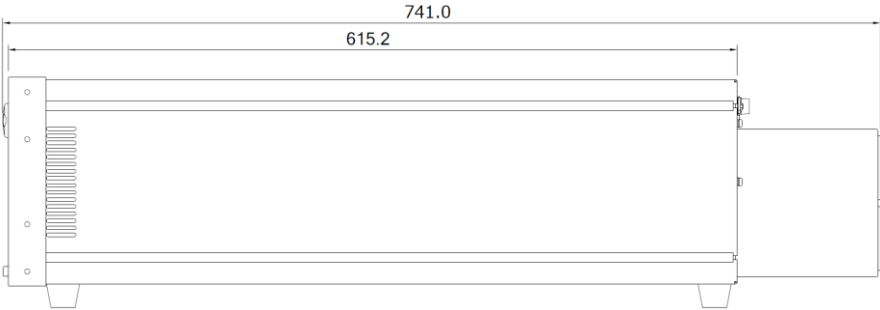
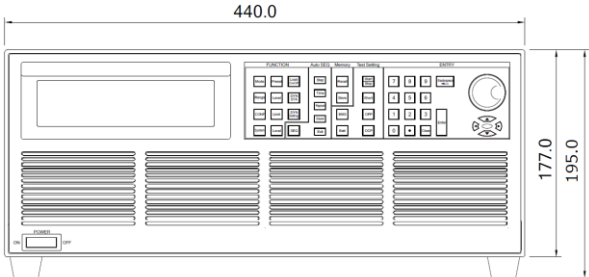

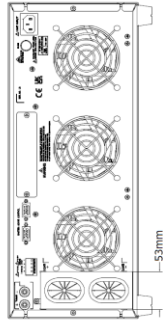
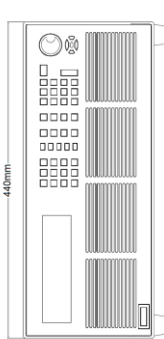
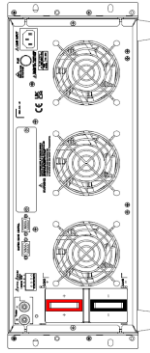
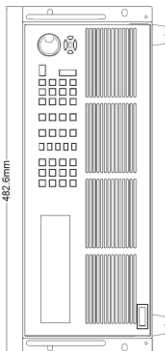
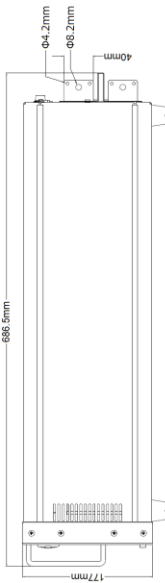
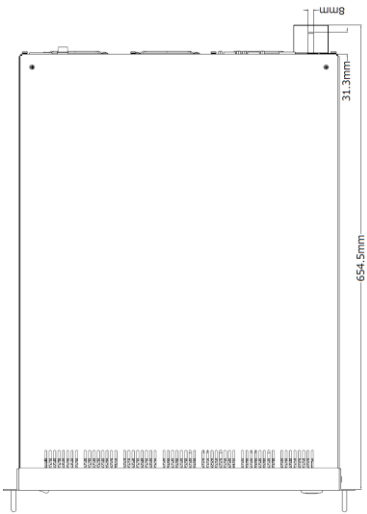



TEXIO TECHNOLOGY CORPORATION

7F Towa Fudosan Shin Yokohama Bldg.

2-18-13, Shin Yokohama, Kohoku-ku, Yokohama, Kanagawa, 222-0033 Japan

<https://www.texio.co.jp/>
