

INSTRUCTION MANUAL

DIGITAL STORAGE OSCILLOSCOPE DCS-1000B SERIES

DCS-1052B

DCS-1054B

DCS-1072B

DCS-1074B

DCS-1102B

DCS-1104B



■ **About a trademark, a registered trademark**

A company name and the brand name mentioned in this instruction manual are the trademark or the registered trademark of each company or group in each country and region.

■ **About this instruction manual**

When copying the part or all of contents of this instruction manual, seek the copyright holder.

In addition, the specifications of the product and the contents of this instruction manual are subject to change without notice for improvement. The latest manuals are posted on our website (<https://www.texio.co.jp/>).

For the purpose of considering the environment and reducing waste, we are progressively eliminating the paper or CD manuals attached to our products.

■ **About export**

When export or ship the product to overseas, please confirm laws and regulations about the export.

Table of Contents

USING THE PRODUCT SAFELY.....	I - V
1. GETTING STARTED.....	1
1-1. Main Features	1
1-2. Accessories	3
Panel Overview	4
1-2-1. Front Panel.....	4
1-2-2. Rear Panel	9
1-2-3. Display.....	10
1-3. Set Up	11
1-3-1. Tilt Stand	11
1-3-2. Power Up.....	12
1-3-3. First Time Use	12
1-3-4. How to Use This Manual	14
1-4. Built-in Help	18
2. MEASUREMENT	19
2-1. Basic Measurement	19
2-1-1. Channel Activation	19
2-1-2. Autoset	20
2-1-3. Run/Stop	21
2-1-4. Horizontal Position/Scale.....	22
2-1-5. Vertical Position/Scale.....	23
2-2. Automatic Measurement	24
2-2-1. Measurement Items.....	24
2-2-2. Add Measurement	27
2-2-3. Remove Measurement	28
2-2-4. Gated mode.....	29
2-2-5. Display All mode.....	29
2-2-6. High Low Function.....	30
2-2-7. Statistics	31
2-2-8. Reference Levels	33
2-3. Cursor Measurement	34
2-3-1. Use Horizontal Cursors	34
2-3-2. Use Vertical Cursors	36
2-4. Math Operation.....	39
2-4-1. Basic Math Overview & Operators	39
2-4-2. FFT Overview & Window Functions	41
2-4-3. Advanced Math Overview.....	43
2-4-4. Advanced Math Operation.....	44
3. CONFIGURATION	46
3-1. Acquisition	46
3-1-1. Select Acquisition Mode	46
3-1-2. Show Waveform in XY Mode.....	47
3-1-3. Set the Record Length.....	49
3-2. Segmented Memory Acquisition (Option).....	49
3-2-1. Segments Display	51
3-2-2. Set the Number of Segments	51

3-2-3. Run Segmented Memory.....	52
3-2-4. Navigate Segmented Memory	53
3-2-5. Play Through Each Segment.....	54
3-2-6. Segment Measurement	54
3-2-7. Automatic Measurement.....	54
3-2-8. Segment Info	57
3-2-9. Save Segment.....	58
3-3. Display.....	60
3-3-1. Display Waveform as Dots or Vectors.....	60
3-3-2. Set the Level of Persistence.....	60
3-3-3. Set the Intensity Level	61
3-3-4. Select Display Graticule	62
3-3-5. Freeze the Waveform (Run/Stop).....	62
3-3-6. Turn Off Menu	63
3-4. Horizontal View	63
3-4-1. Move Waveform Position Horizontally.....	63
3-4-2. Select Horizontal Scale	64
3-4-3. Select reference point of the horizontal expansion.....	64
3-4-4. Select Waveform Update Mode.....	65
3-4-5. Zoom Waveform Horizontally	65
3-4-6. Play/Pause	67
3-5. Vertical View (Channel).....	69
3-5-1. Move Waveform Position Vertically.....	69
3-5-2. Select Vertical Scale	69
3-5-3. Select Coupling Mode	70
3-5-4. Input Impedance.....	70
3-5-5. Invert Waveform Vertically.....	70
3-5-6. Limit Bandwidth.....	71
3-5-7. Expand by Ground/Center.....	71
3-5-8. Select Probe Type.....	72
3-5-9. Select Probe Attenuation Level	73
3-5-10. Set the Deskew	73
3-6. Bus Key Configuration	74
3-6-1. Bus Display	74
3-6-2. Serial Bus.....	75
3-6-3. Threshold Configuration	82
3-7. Trigger	89
3-7-1. Trigger Type Overview	89
3-7-2. Trigger Parameter Overview	91
3-7-3. Setup Holdoff Level.....	94
3-7-4. Setup Trigger Mode.....	95
3-7-5. Using the Edge Trigger.....	95
3-7-6. Using Advanced Delay Trigger.....	96
3-7-7. Using Pulse Width Trigger.....	97
3-7-8. Using Video Trigger.....	98
3-7-9. Pulse Runt trigger.....	99
3-7-10. Using Rise and Fall Trigger.....	100
3-7-11. Using the Timeout Trigger.....	101

3-7-12. Using the Bus Trigger	102
3-7-13. Bus Trigger Mode	109
3-8. Search (Option)	110
3-8-1. Configuring Search Events	110
3-8-2. Copying Search Event To/From Trigger Events	111
3-8-3. Search Event Navigation	112
3-8-4. Save Search Marks	112
3-8-5. Setting/Clearing Single Search Events	113
3-8-6. FFT Peak	113
3-9. System Settings and Miscellaneous Settings	116
3-9-1. Select Menu Language	116
3-9-2. View System Information	116
3-9-3. Erase Memory	117
3-9-4. Probe Compensation Frequency	117
4. Applications	118
4-1. Overview	118
4-2. Running Applications	118
4-3. Using Go-NoGo	119
4-4. Using the DVM (Option)	123
4-5. Using the Data Logger (Option)	124
4-6. Using the Digital Filter (Option)	127
4-7. Remote Disk	128
5. SAVE/RECALL	131
5-1. File Format/Utility	131
5-1-1. Image File Format	131
5-1-2. Waveform File Format	131
5-1-3. Spreadsheet File Format	132
5-1-4. Setup File Format	133
5-2. Create/Edit Labels	135
5-3. Save	137
5-3-1. File Type/Source/Destination	137
5-3-2. Save Image	137
5-3-3. Save Waveform	139
5-3-4. Save Setup	140
5-4. Recall	142
5-4-1. File Type/Source/Destination	142
5-4-2. Recall Default Panel Setting	142
5-4-3. Recall Waveform	144
5-4-4. Recall Setup	145
5-5. Reference Waveforms	146
5-5-1. Recall and Display Reference Waveforms	146
6. FILE UTILITIES	148
6-1-1. File Navigation	148
6-1-2. Create Folder	149
6-1-3. Rename File	150
6-1-4. Delete File or Folder	151
6-1-5. Copy File to USB	151
6-1-6. Installing Optional Apps and Functions	152

7. HARDCOPY	153
7-1-1. Printer I/O Configuration.....	153
7-1-2. Print Output	153
7-1-3. Save - Hardcopy Key.....	154
8. REMOTE CONTROL	156
8-1-1. Configure USB Interface.....	156
8-1-2. Configure the Ethernet Interface	156
8-1-3. Configure Socket Server	158
8-1-4. USB Functionality Check.....	159
8-1-5. Socket Server Functionality Check.....	159
9. MAINTENANCE	164
9-1-1. How to use SPC function.....	164
9-1-2. Vertical Accuracy Calibration.....	164
9-1-3. Probe Compensation.....	165
10. APPENDIX	167
10-1. FAQ	167
10-2. Updating the Firmware	169
10-3. SPECIFICATIONS.....	170
10-3-1. Model Specifications.....	170
10-3-2. Common Specifications.....	170
10-3-3. Probe Specifications.....	173
10-4. DIMENSIONS	174



USING THE PRODUCT SAFELY

■ **Preface**

To use the product safely, read this instruction manual to the end. Before using this product, understand how to correctly use it. If you read this manual but you do not understand how to use it, please ask us or your local dealer. After you read this manual, save it so that you can read it, anytime as required.

■ **Pictorial indication**

This instruction manual and product show the warning and caution items required to safely use the product. The following pictorial indication and warning character indication are provided.

<Pictorial indication>	
	<p>Some part of this product or the instruction manual may shows this pictorial indication. In this case, if the product is incorrectly used in that part, a serious danger may be brought about on the user's body or the product. To use the part with this pictorial indication, be sure to refer to this instruction manual.</p>
 	<p>If you use the product, ignoring this indication, you may get killed or seriously injured. This indication shows that the warning item to avoid the danger is provided.</p> <p>If you incorrectly use the product, ignoring this indication, you may get slightly injured or the product may be damaged. This indication shows that the caution item to avoid the danger is provided.</p>

Please be informed that we are not responsible for any damages to the user or to the third person, arising from malfunctions or other failures due to wrong use of the product or incorrect operation, except such responsibility for damages as required by law.

USING THE PRODUCT SAFELY



- **Do not remove the product's covers and panels**

Never remove the product's covers and panels for any purpose. Otherwise, the user's electric shock or fire may be incurred.
- **Warning on using the product**

Warning items given below are to avoid danger to user's body and life and avoid the damage or deterioration of the product.
Use the product, observing the following warning and caution items.
- **Warning items on power supply**
 - Power supply voltage

The rated power supply voltages of the product are 100, 120, 220 and 240VAC. The rated power supply voltage for each product should be confirmed by reading the label attached on the back of the product or by the "rated" column shown in this instruction manual. The specification of power cord attached to the products is rated to 125VAC for all products which are designed to be used in the areas where commercial power supply voltage is not higher than 125VAC. Accordingly, you must change the power cord if you want to use the product at the power supply voltage higher than 125VAC. If you use the product without changing power cord to 250VAC rated one, electric shock or fire may be caused.
When you used the product equipped with power supply voltage switching system, please refer to the corresponding chapter in the instruction manuals of each product.
 - Power cord
(Important) The attached power cord set can be used for this device only.

If the attached power cord is damaged, stop using the product and call us or your local dealer. If the power cord is used without the damage being removed, an electric shock or fire may be caused.
 - Protective fuse

If an input protective fuse is blown, the product does not operate. For a product with external fuse holder, the fuse may be replaced. As for how to replace the fuse, refer to the corresponding chapter in this instruction manual.
If no fuse replacement procedures are indicated, the user is not permitted to replace it. In such case, keep the case closed and consult us or your local dealer. If the fuse is incorrectly replaced, a fire may occur.

USING THE PRODUCT SAFELY

■ **Warning item on Grounding**

If the product has the GND terminal on the front or rear panel surface, be sure to ground the product to safely use it.

■ **Warnings on Installation environment**

● Operating temperature and humidity

Use the product within the operating temperature indicated in the “rating” temperature column. If the product is used with the vents of the product blocked or in high ambient temperatures, a fire may occur. Use the product within the operating humidity indicated in the “rating” humidity column. Watch out for condensation by a sharp humidity change such as transfer to a room with a different humidity. Also, do not operate the product with wet hands. Otherwise, an electric shock or fire may occur.

● Use in gas

Use in and around a place where an inflammable or explosive gas or steam is generated or stored may result in an explosion and fire. Do not operate the product in such an environment.

Also, use in and around a place where a corrosive gas is generated or spreading causes a serious damage to the product. Do not operate the product in such an environment.

● Installation place

Avoid installing the product on inclined places or on places subject to vibration. Otherwise, the product may slip or fall down to cause damages or injury accidents.

■ **Do not let foreign matter in**

Do not insert metal and inflammable materials into the product from its vent and spill water on it. Otherwise, electric shock or fire may occur.

■ **Warning item on abnormality while in use**

In abnormal situations, such as “smoke”, “fire”, “abnormal smell” or “irregular noise” occur from the product while in use, stop using the product, turn off the switch, and remove the power cord plug from the outlet. After confirming that no other devices catch fire, ask us or your local dealer.

USING THE PRODUCT SAFELY

■ Warning Item for the Measurement

- When you measure a part of a high voltage, be careful not to touch a hand to a measurement part directly. There is a risk of an electric shock.
 - Be sure to connect the probe or the cable and the ground side of the input connector to the ground potential (ground) of the substance measured. Since the chassis of this instrument is connected to the ground of the input block, connecting the earth lead of the probe to the potential floating from the ground potential may result in the following:
 - Electric shock
 - A high current flows and damages the substance measured, this instrument, and other connected device.
- The following parts are connected to the chassis:
- Probe for each channel and ground side of the input BNC connector
 - Grounding conductor of the accessory 3-core power cord
 - Ground pin for an interface signal

“Bad example”

Prohibition

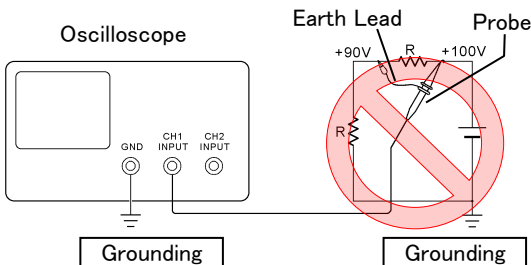

At connecting as Bad Example, +90V and chassis are shorted, and damages substance a measured. Therefore do not make such connection.

If the instrument is not grounded, a potential of the chassis is +90V. Ground a chassis, in order to prevent an electric shock accident.

When measuring the floating potential, a differential method of measurement is recommended (refer to the figure below).

“Good example”

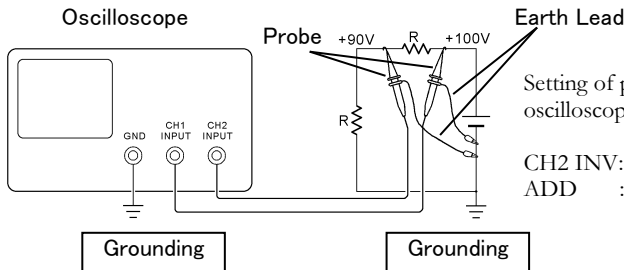

Setting of panel switches of an oscilloscope

CH2 INV: ON (CH2 inverted)
ADD : ON (CH1+CH2)

USING THE PRODUCT SAFELY

■ **Input / Output terminals**

Maximum input to terminal is specified to prevent the product from being damaged. Do not supply input, exceeding the specifications that are indicated in the "Rating" column in the instruction manual of the product.

Also, do not supply power to the output terminals from the outside.

Otherwise, a product failure is caused.

■ **Calibration**

Although the performance and specifications of the product are checked under strict quality control during shipment from the factory, they may be deviated more or less by deterioration of parts due to their aging or others.

It is recommended to periodically calibrate the product so that it is used with its performance and specifications stable.

For consultation about the product calibration, ask us or your local dealer.

■ **Daily Maintenance**

When you clean off the dirt of the product covers, panels, and knobs, avoid solvents such as thinner and benzene. Otherwise, the paint may peel off or resin surface may be affected.

To wipe off the covers, panels, and knobs, use a soft cloth with neutral detergent in it. During cleaning, be careful that water, detergent, or other foreign matters do not get into the product.

If a liquid or metal gets into the product, an electric shock and fire are caused. During cleaning, remove the power cord plug from the outlet.

Use the product correctly and safely, observing the above warning and caution items. Because the instruction manual indicates caution items even in individual items, observe those caution items to correctly use the product.

If you have questions or comments about the instruction manual, ask us or E-Mail us.

1. GETTING STARTED

This chapter describes the DCS-1000B in a nutshell, including its main features and front / rear panel introduction. After going through the overview, follow the Set Up section to properly set up the oscilloscope for first time use. The Set Up section also includes a starter on how to use this manual effectively.



1-1. Main Features

Model name	Frequency bandwidth	Input channels	Real-time Sampling Rate
DCS-1052B	50MHz	2	1GSa/s
DCS-1054B	50MHz	4	1GSa/s
DCS-1074B	70MHz	4	1GSa/s
DCS-1104B	100MHz	4	1GSa/s
DCS-1072B	70MHz	2	1GSa/s
DCS-1102B	100MHz	2	1GSa/s



Note

This instruction manual has been described as the 4ch model. In 2ch model, Can't set the ch3 and ch4.

Features	<ul style="list-style-type: none"> • 7 inch, 800 x 480, WVGA TFT display. • Available from 70MHz to 100MHz. • Real-time sampling rate of 1GSa/s. • Deep memory: 10M points record length. • Waveform capture rate of 50,000 waveforms per second. • Vertical sensitivity: 1mV/div~10V/div. • On-screen Help. • 32 MB internal flash disk. • Go-NoGo application. • Remote Disk appl • Serial Bus Decode: Serial bus decoding of UART, I2C, SPI, CAN & LIN buses.ication.
Additional Feature	<ul style="list-style-type: none"> • Segmented Memory: Optimizes the acquisition memory to selectively capture only the important signal details. Up to 29000 successive waveform segments can be captured with a time-tag resolution of 4ns. • Waveform Search: Allows the scope to search for a number of different signal events.
Interface	<ul style="list-style-type: none"> • USB host port: front panel, for storage devices. • USB device port: rear panel, for remote control or printing. • Probe calibration output with selectable output frequency (1kHz ~ 200kHz). • Ethernet port (4ch Model Only) • Calibration output.

1-2. Accessories

Standard Accessories	Part number	Description
Power cord		N/A region dependent
Passive probe for 50MHz /70MHz Model	GTP-070B-4	x4 or x2 70 MHz probe
Passive probe for 100MHz Model	GTP-100B-4	100MHz probe
Standard Apps	Name	Description
	Go-NoGo	Go-NoGo testing app.
	Remote Disk	Allows the scope to mount a network share drive.
Optional Apps	Name	Description
	Data Log	Waveform or image data logging app.
	DVM	Digital Volt Meter app.
	Digital Filter	High or low pass digital filter for analog inputs.
Optional Function	Part number	Description
	Segment	Segment memory Function
	Search	Search Function
Optional Accessories	Part number	Description
	GTL-110	test lead, BNC to BNC heads
	GTL-246	USB2.0 A - B type cable
Drivers		
	USB driver	

* Note: We reserves the right to change the probe model type at anytime without notice for probe model types of similar specification.

Panel Overview
1-2-1. Front Panel
4ch Model

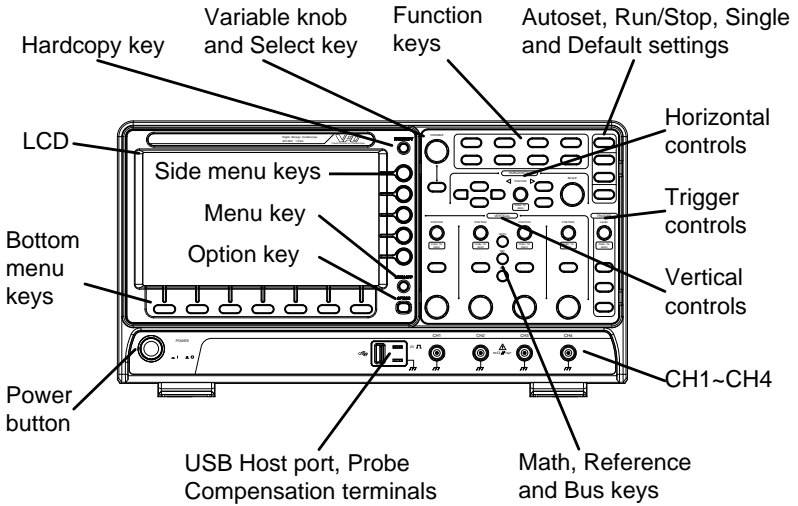

2ch Model

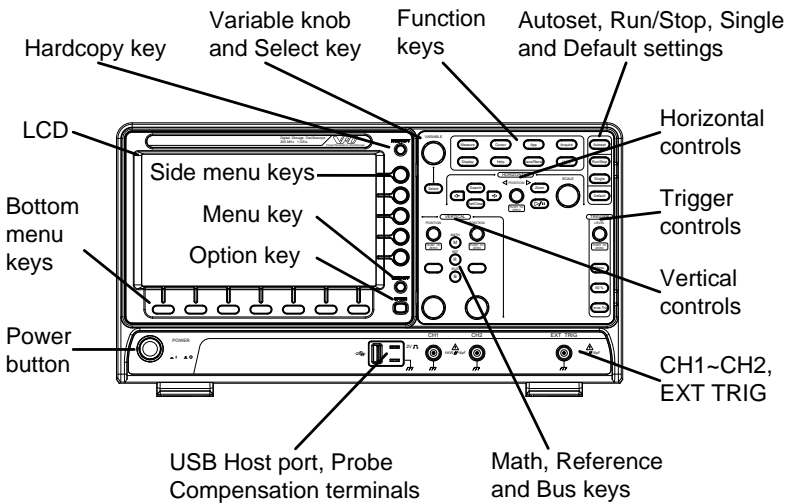

LCD Display 7" WVGA TFT color LCD. 800 x 480 resolution, wide angle view display.

Menu Off Key **MENU OFF** Use the Menu Off key to hide the onscreen menu system.



Option Key **OPTION** The Option key is used to access future installed options.



Menu Keys The side menu and bottom menu keys are used to make selections from the soft-menus on the LCD user interface. To choose menu items, use the 7 Bottom menu keys located on the bottom of the display panel. To select a variable or option from a menu, use the side menu keys on the side of the panel. See page 14 for details.

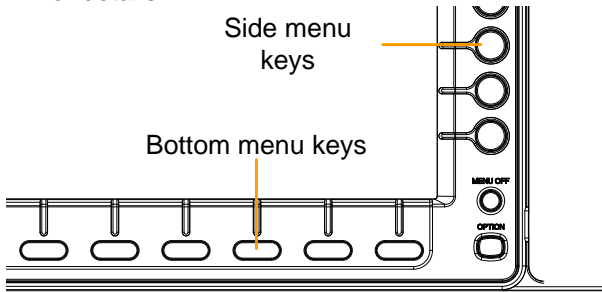

Hardcopy Key **HARDCOPY** The Hardcopy key is a quick-save or quick-print key, depending on its configuration.





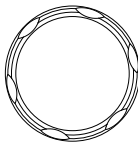





Variable Knob and Select Key **VARIABLE** The Variable knob is used to increase/decrease values or to move between parameters. The Select key is used to make selections.



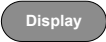
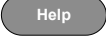

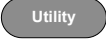
Function Keys The Function keys are used to enter and configure different functions on the DCS-1000B.

Measure **Measure** Configures and runs automatic measurements.

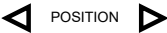

Cursor		Configures and runs cursor measurements.
APP		Configures and runs optional applications.
Acquire		Configures the acquisition mode, including Segmented Memory acquisition.
Display		Configures the display settings.
Help		Shows the Help menu.
Save/Recall		Used to save and recall waveforms, images, panel settings.
Utility		Configures the Hardcopy key, Interface, language, probe compensation and calibration. It also accesses the file utilities menu or the system menu.
Autoset		Press the Autoset key to automatically set the trigger, horizontal scale and vertical scale.
Run/Stop Key		Press to Freeze (Stop) or continue (Run) signal acquisition. The run stop key is also used to run or stop Segmented Memory acquisition .
Single		Sets the acquisition mode to single triggering mode.
Default Setup		Resets the oscilloscope to the default settings.

Horizontal Controls The horizontal controls are used to change the position of the cursor, set the time base settings, zoom into the waveforms and search for events.

Horizontal Position  POSITION  The Position knob is used to position the waveforms horizontally on the display screen. Pressing the knob will reset the position to zero.















PUSH TO ZERO

SCALE

SCALE The Scale knob is used to change the horizontal scale (TIME/DIV).



Zoom		Press Zoom in combination with the horizontal Position knob.
Play/Pause		The Play/Pause key allows you to view each search event in succession – to effectively “play” through each search event. It is also used to play through a waveform in zoom mode.
Search		The Search key accesses the search function menu to set the search type, source and threshold. (Optional function)
Search Arrows		Use the arrow keys to navigate the search events. (Optional function)
Set/Clear		Use the Set/Clear key to set or clear points of interest when using the search function. (Optional function)
Trigger Controls	The trigger controls are used to control the trigger level and options.	
Level Knob	 <p style="text-align: center;">LEVEL</p>	Used to set the trigger level. Pressing the knob will reset the level to zero.
Trigger Menu Key		Used to bring up the trigger menu.
50% Key		Sets the trigger level to the half way point (50%).
Force - Trig		Press to force an immediate trigger of the waveform.
Vertical POSITION	 <p style="text-align: center;">POSITION</p>  <p style="text-align: center;">PUSH TO ZERO</p>	Sets the vertical position of the waveform. Push the knob to reset the vertical position to zero.
Channel Menu Key		Press the CH1~4 key to set and configure the channel.
VOLTS/DIV Knob	 <p style="text-align: center;">VOLTS/DIV</p>	Sets the vertical scale of the channel (VOLTS/DIV).

External Trigger Input

EXT TRIG

Accepts external trigger signals (page 89). Only on 2 channel models.

Input impedance: 1MΩ

Voltage input: ±15V(peak), EXT trigger capacitance:16pF.



Math Key

MATH



Use the Math key to set and configure math functions.

Reference Key

REF



Press the Reference key to set or remove reference waveforms.

BUS Key

BUS



The Bus key is used for parallel and serial bus (UART, I²C, SPI, CAN, LIN) configuration.

Channel Inputs

CH1

Accepts input signals.
Input impedance: 1MΩ.
Capacitance: 16pF

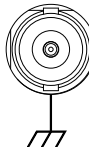

USB Host Port

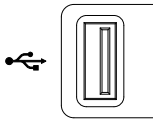

TypeA, 1.1/2.0 compatible.
Used for USB memory.

Ground Terminal

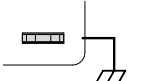

Accepts the DUT ground lead for common ground.

Probe Compensation Outputs

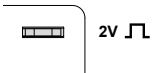

The probe compensation output is used for probe compensation. It also has an adjustable output frequency.

By default this port outputs a 2Vpp, square wave signal at 1kHz for probe compensation.

Power Switch



POWER



■ | ○: ON

■ ○: OFF

1-2-2. Rear Panel

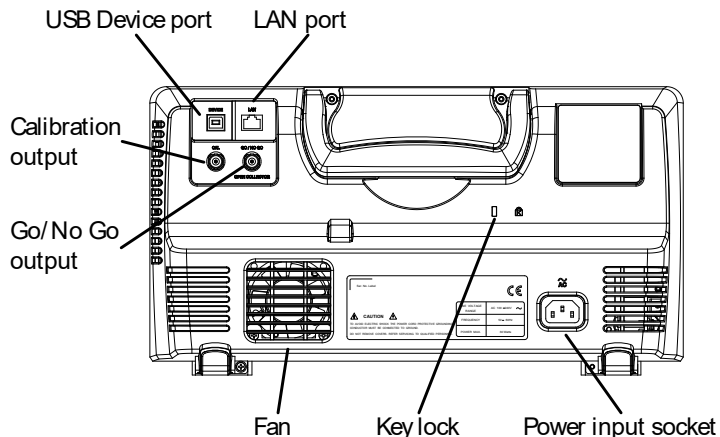

Calibration Output

CAL

Outputs the signal for vertical scale accuracy calibration.

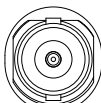

USB Device Port

DEVICE

The USB Device port is used for remote control.



LAN (Ethernet) Port

LAN

The LAN port is used for remote control over a network or when combined with the Remote Disk app, allows the scope to be mounted to a share disk.

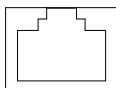

Power Input Socket

AC

Power cord socket accepts AC mains, 100 ~ 240V, 50/60Hz.

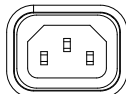

Security Slot



Kensington security slot compatible.

Go-No Go
Output

GO / NO GO

Outputs Go-No Go test results as a
500us pulse signal.







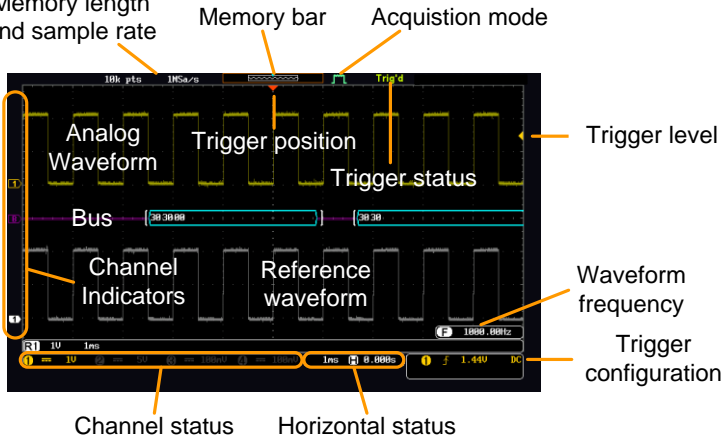



OPEN COLLECTOR

1-2-3. Display
Memory length
and sample rate

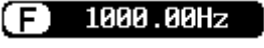

Analog Waveforms	Shows the analog input signal waveforms. Channel 1: Yellow Channel 2: Blue Channel 3: Pink Channel 4: Green
Bus Waveforms	Shows the bus waveforms for serial buses. The values are displayed in hex or binary.
Channel Indicators	The channel indicators show the zero volt level of the signal waveform for each activated channel. Any active channel is shown with a solid color. 3 Analog channel indicator B Bus indicator(B) 1 Reference waveform indicator M Math indicator
Trigger Position	Shows the position of the trigger.
Horizontal Status	Shows the horizontal scale and position.
Trigger Level	
Memory Bar	

The ratio and the position of the displayed waveform compared to the internal memory

Trigger Status	Trig'd	Triggered.
	PrTrig	Pre-trigger.
	Trig?	Not triggered, display not updated.
	Stop	Trigger stopped. Also appears in Run/Stop (page 21).
	Roll	Roll mode.
Acquisition Mode	Auto	Auto trigger mode. For trigger details, see page 89.
		Normal mode
		Peak detect mode
		Average mode
For acquisition details, see page 46.		
Signal Frequency	 1000.00Hz	Shows the trigger source frequency.
	 <2Hz	Indicates the frequency is less than 2Hz (lower frequency limit).
Trigger Configuration	 1 f 2.32V DC	Trigger source, slope, voltage, coupling.
	 1ns  0.000s	Horizontal scale, horizontal position.
For trigger details, see page 89.		
Channel Status	 1 == 2V	Channel 1, DC coupling, 2V/Div.

1-3. Set Up
1-3-1. Tilt Stand

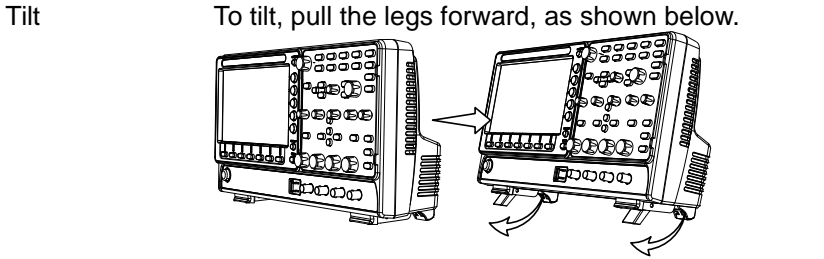

Stand

To stand the scope upright, push the legs back under the casing as shown below.

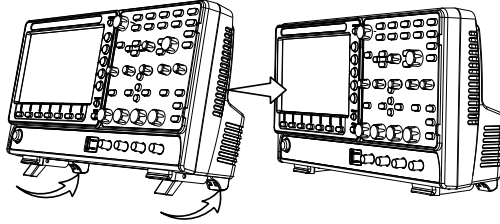

1-3-2. Power Up

Requirements The DCS-1000B accepts line voltages of 100 ~ 240V at 50 or 60Hz.

Step

1. Connect the power cord to the rear panel socket.

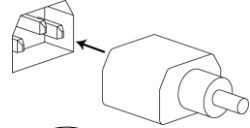

2. Press the POWER key. The display becomes active in ~ 30 seconds.



■ I : ON ■ O : OFF

! Note

The DCS-1000B recovers the state right before the power is turned OFF. The default settings can be recovered by pressing the Default key on the front panel. For details, see page 142.

1-3-3. First Time Use

Background This section describes how to connect a signal, adjust the scale, and compensate the probe. Before operating the DCS-1000B in a new environment, run these steps to make sure the instrument performs at its full potential.

- 1. Power On Follow the procedures on the previous page.
- 2. Firmware Update to the latest firmware. Page 169
- 3. Optional application Add the Optional application, depending on the necessity. Page 118
- 4. Reset System Reset the system by recalling the factory settings. Press the *Default* key on the front panel. For details, see page 142.



5. Connect Probe

Connect the probe to the Channel 1 input and to the CAL signal output. This output provides a 2Vp-p, 1kHz square wave for signal compensation by default. Set the probe attenuation to x10 if the probe has adjustable attenuation.

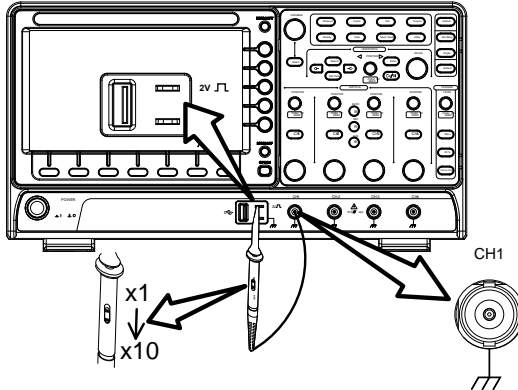

6. Capture Signal (Autoset)

Press the *Autoset* key. A square waveform appears on the center of the screen. For Autoset details, see page 20.

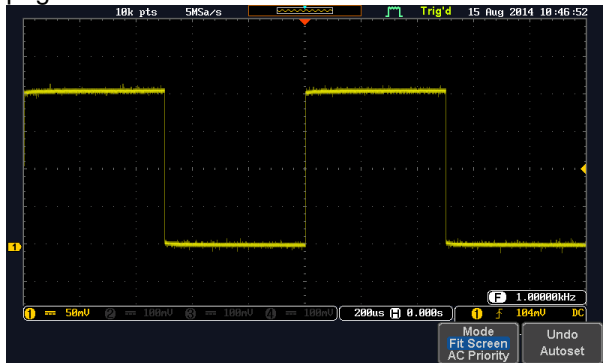

7. Select Vector Waveform

Press the *Display* key, and set the display to *Vector* on the bottom menu.

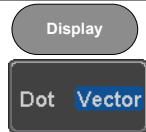
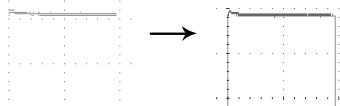

8. Compensate Probe

Turn the adjustment point on the probe to make the square waveform edge flat.

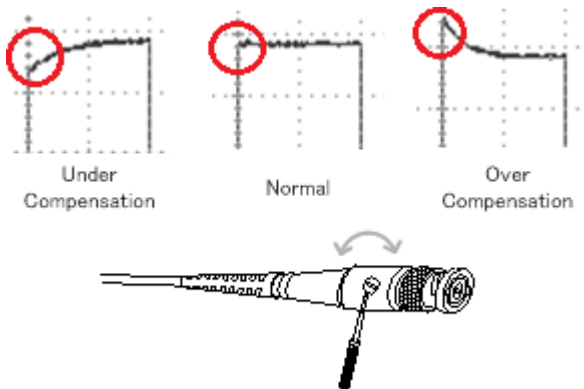

9. Start Operation	Continue with the other operations.
	Measurement: page 19
	Configuration: page 46
	Save/Recall: page 131
	File Utilities: page 148
	Apps: page 118
	Hardcopy key: page 153
	Remote Control: page 156
	Maintenance: page 164

1-3-4. How to Use This Manual

Background This section describes the conventions used in this manual to operate the DCS-1000B. Throughout the manual any reference to pressing a menu key refers to the keys directly below or beside any menu icons or parameters. When the user manual says to “toggle” a value or parameter, press the corresponding menu item. Pressing the item will toggle the value or parameter. Active parameters are highlighted for each menu item. For example in the example below, Coupling is currently set to DC. If a menu item can be toggled from one value or parameter to another, the available options will be visible, with the current option highlighted. In the example below the slope can be toggled from a rising slope to a falling slope or either slope.

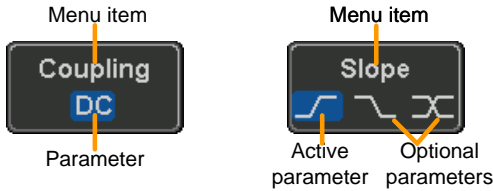

Selecting a Menu Item, Parameter or Variable

When the user manual says to “select” a value from one of the side menu parameters, first press the corresponding menu key and use the Variable knob to either scroll through a parameter list or to increase or decrease a variable.

Example 1

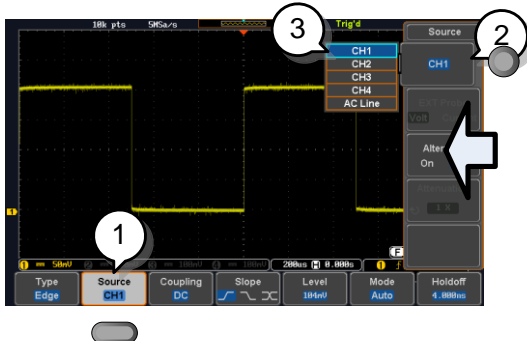

1. Press a bottom menu key to access the side menu.
2. Press a side menu key to either set a parameter or to access a sub menu.
3. If accessing a sub menu or setting a variable parameter, use the Variable knob to scroll through menu items or variables. Use the Select key to confirm and exit.

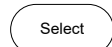
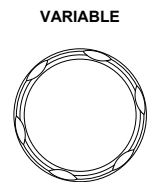
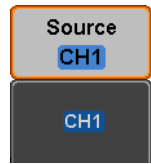

4. Press the same bottom menu key again to reduce the side menu.



Example 2

For some variables, a circular arrow icon indicates that the variable for that menu key can be edited with the Variable knob.

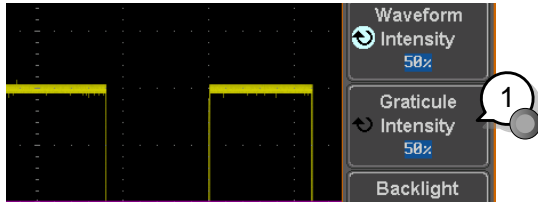

1. Press the desired menu key to select it. The circular arrow will become highlighted.



2. Use the Variable knob to edit the value.

Toggleing a Menu Parameter

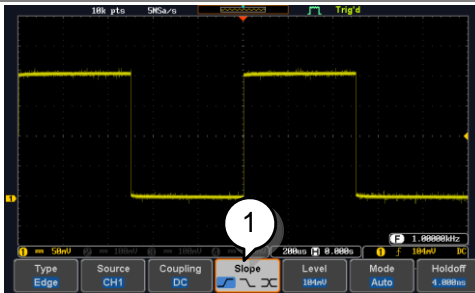

1. Press the bottom menu key to toggle the parameter.



Reduce Side Menu

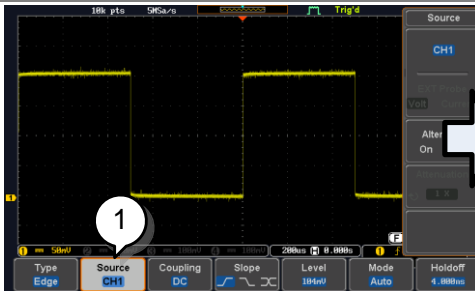

2. To reduce the side menu, press the corresponding bottom menu that brought up the side menu.

For example: Press the *Source* soft-key to reduce the *Source* menu.

Reduce Lower Menu

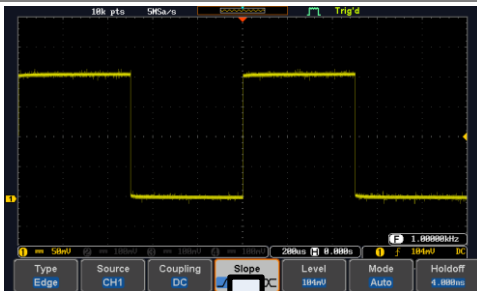

1. Press the relevant function key again to reduce the bottom menu. For example: press the Trigger Menu key to reduce the trigger menu.

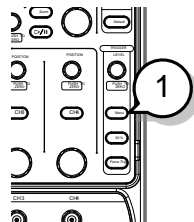

Remove All Menus

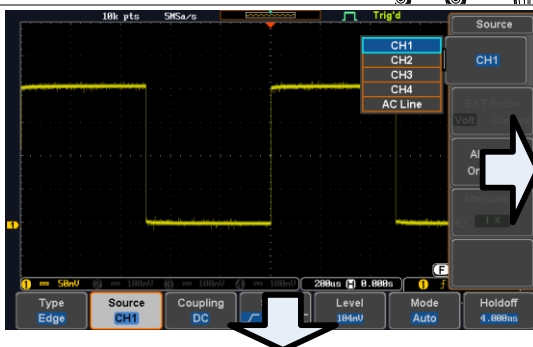

1. Press the *Menu Off* key to reduce the side menu, press again to reduce the bottom menu.

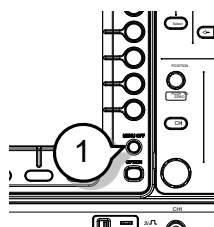

Remove On-Screen Messages

2. The *Menu Off* key can also be used to remove any on screen messages.

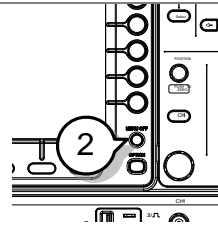

1-4. Built-in Help

The Help key accesses a context sensitive help menu. The help menu contains information on how to use the front panel keys.

Panel Operation

1. Press the *Help* key. The display changes to Help mode.
2. Use the *Variable* knob to scroll up and down through the Help contents. Press *Select* to view the help on the selected item.



Example: Help on the Display key

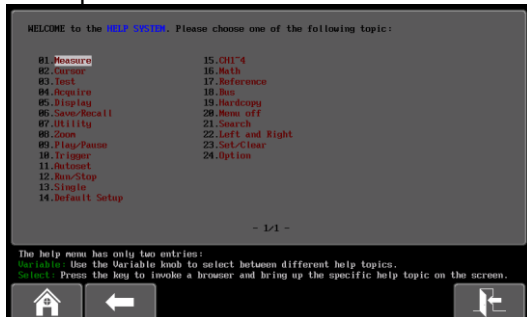

Home Key

Press the *Home* key to return to the main help screen.



Go Back

Press the *Back* key to go to the previous menu page.



Exit

Press the *Help* key again or press the *Exit* key to exit the Help mode.

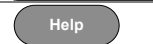

2. MEASUREMENT

2-1. Basic Measurement

This section describes the basic operations required in capturing and viewing the input signal. For more detailed operations, see the following chapters.

- Cursor Measurement → from page 34
- Configuration → from page 46

Before operating the oscilloscope, please see the Getting Started chapter, page 4.

2-1-1. Channel Activation

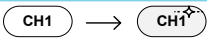
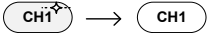
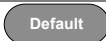
Activate Channel	To activate an input channel, press a <i>channel</i> key. When activated, the channel key will light up. The corresponding channel menu will also appear. Each channel is associated with the color shown beside each channel's VOLT/DIV knob: CH1: yellow, CH2: blue, CH3: pink and CH4: green. When a channel is activated, it is shown above the bottom menu system.	
De-activate Channel	To de-activate a channel, press the corresponding <i>channel</i> key again. If the channel menu is not open, press the <i>channel</i> key twice (the first press shows the Channel menu).	
Default Setup	To activate the default state, press <i>Default</i> .	

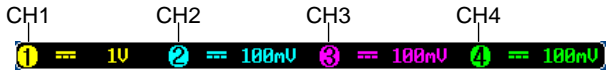

2-1-2. Autoset

Background

The Autoset function automatically configures the panel settings to position the input signal(s) to the best viewing condition. The DCS-1000B automatically configures the following parameters:

- Horizontal scale
- Vertical scale
- Trigger source channel

There are two operating modes for the Autoset function: Fit Screen Mode and AC Priority Mode. Fit Screen Mode will fit the waveform to the best scale, including any DC components (offset). AC priority mode will scale the waveform to the screen by removing any DC component.

Panel Operation

1. Connect the input signal to the DCS-1000B and press the



2. The waveform appears in the center of the display.

Before

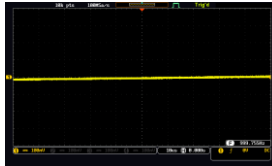

After

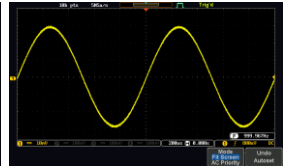

3. To undo Autoset, press *Undo Autoset* from the bottom menu.



Change modes

4. Choose between *Fit Screen Mode* and *AC Priority Mode* from the bottom menu.



5. Press the *Autoset* key again to use Autoset in the new mode.



Fit Screen Mode

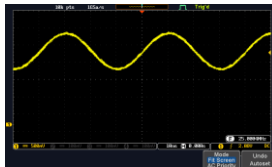

AC Priority

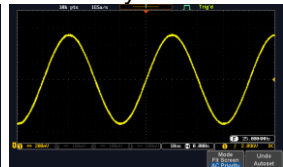

Limitation	Autoset does not work in the following situations: <ul style="list-style-type: none"> • Input signal frequency is less than 20Hz • Input signal amplitude is less than 10mV
------------	---

 **Note**
The Autoset key does NOT automatically activate the channels to which input signals are connected.





2-1-3. Run/Stop



Background By default, the waveform on the display is constantly updated (Run mode). Freezing the waveform by stopping signal acquisition (Stop mode) allows flexible observation and analysis. To enter Stop mode, two methods are available: pressing the Run/Stop key or using the Single Trigger mode.

Stop mode icon When in Stop mode, the Stop icon appears at the top of the display.



Triggered icon

Freeze Waveform using the Run/Stop Key	Press the <i>Run/Stop</i> key once. The Run/Stop key turns red. The waveform and signal acquisition freezes.	Stop:  → 
	To unfreeze, press the <i>Run/Stop</i> key again. The Run/Stop key turns green again.	Run:  → 

Freeze Waveform by Single Trigger Mode	Press the <i>Single</i> key to go into the Single Trigger mode. The Single key turns bright white. In the Single Trigger mode, the scope will be put into the pre-trigger mode until the scope encounters the next trigger point. After the scope has triggered, it will remain in Stop mode, until the <i>Single</i> key is pressed again or the <i>Run/Stop</i> key is pressed.	 → 
--	---	---

Waveform Operation	The waveform can be moved or scaled in both Run and Stop mode, but in different manners. For details, see page 63 (Horizontal position/scale) and page 69 (Vertical position/scale).
--------------------	--

2-1-4. Horizontal Position/Scale

For more detailed configuration, see page 63.

Set Horizontal Position

The horizontal position knob moves the waveform left and right.

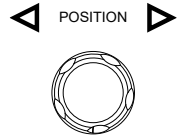

PUSH TO ZERO

Set Horizontal Position to 0

Pressing the horizontal position knob will reset the horizontal position to 0.

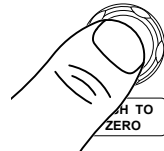
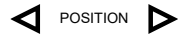

Acquire

Reset H Position to 0s

Alternatively, pressing the *Acquire* key and then pressing *Reset H Position to 0s* from the bottom menu will also reset the horizontal position.

As the waveform moves, the display bar on the top of the display indicates the portion of the waveform currently shown on the display and the position of the horizontal marker on the waveform.



Position Indicator

The horizontal position is shown at the bottom of the display grid to the right of the H icon.



Select Horizontal Scale

To select the timebase, turn the horizontal *SCALE* knob; left (slow) or right (fast).

SCALE

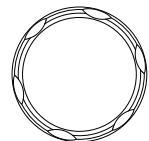

Range 5ns/div ~ 100s/div, 1-2-5 increments
The scale is displayed to the left of the H icon at the bottom of the screen.



Display bar The display bar indicates how much of the waveform is displayed on the screen at any given time. Changes to timebase will be reflected on the display bar.



Stop mode In the Stop mode, the waveform size changes according to the scale.

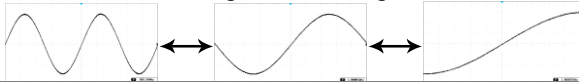

Note

The Sample rate changes according to the timebase and record length. See page 49.

2-1-5. Vertical Position/Scale

For more detailed configuration, see page 69.

Set Vertical Position

To move the waveform up or down, turn the *vertical position knob* for each channel.

POSITION



PUSH TO ZERO

POSITION

Push the *vertical position knob* to reset the position to 0.

As the waveform moves, the vertical position of the cursor appears on the display.

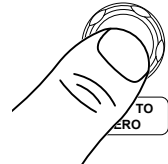

Position = 1.84mV

Run/Stop mode

The waveform can be moved vertically in both Run and Stop mode.

Select Vertical Scale

To change the vertical scale, turn the vertical VOLTS/DIV knob; left (down) or right (up).

VOLTS/DIV



Range

1mV/div ~ 10V/div
1-2-5 increments

The vertical scale indicator for each channel on the bottom of the display changes accordingly.































2-2. Automatic Measurement









The automatic measurement function measures and updates major items for Voltage/Current, Time, and Delay type measurements.

2-2-1. Measurement Items

	V/I Measurements	Time Meas.	Delay Meas.	
Overview	Pk-Pk		Frequency	
	Max		Period	
	Min		RiseTime	
	Amplitude		FallTime	
	High		+Width	
	Low		-Width	
	Mean		Dutycycle	
	Cycle Mean		+Pulses	
	RMS		-Pulses	
	Cycle RMS		+Edges	
	Area		-Edges	
	Cycle Area			
	ROVShoot			
	FOVShoot			
	RPREShoot			
	FPREShoot			
	Voltage/Current Measurement	Pk-Pk (peak to peak)		Difference between positive and negative peak. (=max - min)
Max			Positive peak.	
Min			Negative peak.	

Amplitude		Difference between the global high value and the global low value, measured over the entire waveform or gated region. (=high – low)
High		Global high voltage. See page 30 for details.
Low		Global low voltage. See page 30 for details.
Mean		The arithmetic mean value is calculated for all data samples as specified by the Gating option.
Cycle Mean		The arithmetic mean value is calculated for all data samples within the first cycle found in the gated region.
RMS		The root mean square of all data samples specified by the Gating option.
Cycle RMS		The root mean square value is calculated for all data samples within the first cycle found in the gated region.
Area		Measures the positive area of the waveform and subtracts it from the negative area. The ground level determines the division between positive and negative areas.
Cycle Area		The Summation based on all data samples within the first cycle found in the gated region.
ROVShoot		Rise overshoot
FOVShoot		Fall overshoot
RPRE-Shoot		Rise preshoot
FPRE-Shoot		Fall preshoot

Time Measurement	Frequency		Frequency of the waveform.	
	Period		Waveform cycle time. (=1/Freq)	
	RiseTime		The time required for the leading edge of the first pulse to rise from the low reference value to the high reference value.	
	FallTime		The time required for the falling edge of the first pulse to fall from the high reference value to the low reference value.	
	+Width		Positive pulse width.	
	-Width		Negative pulse width.	
	Duty Cycle		Ratio of signal pulse compared with whole cycle. =100x (Pulse Width/Cycle)	
	+Pulses		Measures the number of positive pulses.	
	-Pulses		Measures the number of negative pulses.	
	+Edges		Measures the number of positive edges.	
	-Edges		Measures the number of negative edges.	
	Delay Measurement	FRR		Time between: Source 1 first rising edge and Source 2 first rising edge.
		FRF		Time between: Source 1 first rising edge and Source 2 first falling edge.
FFR			Time between: Source 1 first falling edge and Source 2 first rising edge.	
FFF			Time between: Source 1 first falling edge and Source 2 first falling edge.	

LRR		Time between: Source 1 first rising edge and Source 2 last rising edge.
LRF		Time between: Source 1 first rising edge and Source 2 last falling edge.
LFF		Time between: Source 1 first falling edge and Source 2 last rising edge.
LRR		Time between: Source 1 first rising edge and Source 2 last rising edge.
LRF		Time between: Source 1 first rising edge and Source 2 last falling edge.
LRF		Time between: Source 1 first falling edge and Source 2 last rising edge.
LRF		Time between: Source 1 first falling edge and Source 2 last falling edge.
Phase		The phase difference of two signals, calculated in degrees. $\frac{t1}{t2} \times 360^\circ$



Note

The in-built help system can be used to see detailed automatic measurement definitions.

2-2-2. Add Measurement

The *Add Measurement* function allows you to add up to eight automatic measurement items on the bottom of the screen from any channel source.

Add
Measurement
Item

1. Press the *Measure* key.
2. Press *Add Measurement* from the bottom menu.
3. Choose either a *V/I*, *Time* or *Delay* measurement from the side menu and choose the type of measurement you wish to add.

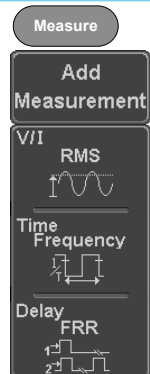

V/I (Voltage/Current) Pk-Pk, Max, Min, Amplitude, High, Low, Mean, Cycle Mean, RMS, Cycle RMS, Area, Cycle Area, ROVShoot, FOVShoot, RPREShoot, FPREShoot

Time Frequency, Period, RiseTime, FallTime, +Width, -Width, Duty Cycle, +Pulses, -Pulses, +Edges, -Edges

Delay FRR, FRF, FFR, FFF, LRR, LRF, LFR, LFF, Phase

- All of the chosen automatic measurements will be displayed in a window on the bottom of the screen. The channel number and channel color indicate the measurement source. For the analog inputs: yellow = CH1, blue = CH2, pink = CH3, green = CH4.

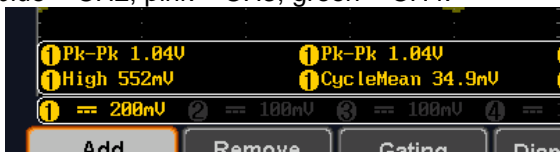

Choose a Source

The channel source for measurement items can be set either before or when selecting a measurement item.

- To set the source, press either the *Source1* or *Source2* key from the side menu and choose the source. Source 2 is only applicable for delay measurements.



Range CH1~ CH4, Math

2-2-3. Remove Measurement

Individual measurements can be removed at any time using the Remove Measurement function.

Remove Measurement Item

- Press the *Measure* key.
- Press *Remove Measurement* from the bottom menu.
- Press *Select Measurement* and select the item that you want to remove from the measurement list.



Remove All Items

Press *Remove All* to remove all the measurement items.

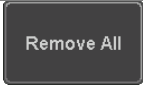

2-2-4. Gated mode

Some automatic measurements can be limited to a “gated” area between cursors. Gating is useful for measuring a magnified waveform or when using a fast time base. The Gated mode has three possible configurations: Off (Full Record), Screen and Between Cursors.

Set Gating Mode 1. Press the *Measure* key.

2. Press *Gating* from the bottom menu.
3. Choose one of the gating modes from the side menu: *Off (full record)*, *Screen*, *Between Cursors*.



Cursors On Screen

If *Between Cursors* is selected, the cursor positions can be edited by using the cursor menu.

Page 34

2-2-5. Display All mode

Display All mode shows and updates all items from Voltage and Time type measurements.

View Measurement Results

1. Press the *Measure* key.
2. Press *Display All* from the bottom menu.
3. Press *Source* from the side menu and choose a measurement source.
Range CH1~CH4, Math
4. The results of Voltage and Time type measurements appear on the display.

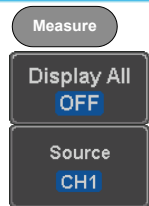



Remove Measurements To remove the measurement results, press *OFF*.

Delay Measurements Delay type measurements are not available in this mode as only one channel is used as the source. Use the individual measurement mode (page 27) instead.

2-2-6. High Low Function

Background The High-Low function is used to select the method for determining the value of the High-Low measurement values.

Auto Automatically chooses the best high-low setting for each waveform when measuring.

Histogram Uses histograms to determine the high-low values. This mode ignores any preshoot and overshoot values. This mode is particularly useful for pulse-type waveforms

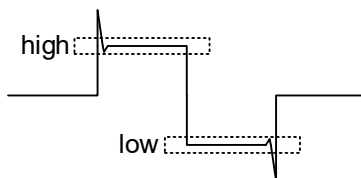

Min-max

Sets the high-low values as the minimum or maximum measured values.

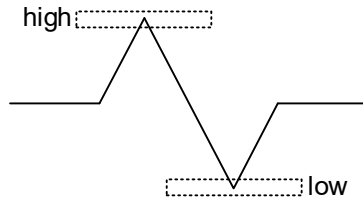

Set High-Low

1. Press the *Measure* key.



2. Press *High-Low* from the bottom menu.



3. Select the type of High-Low settings from the side menu.

High-Low Settings: Histogram, Min-Max, Auto

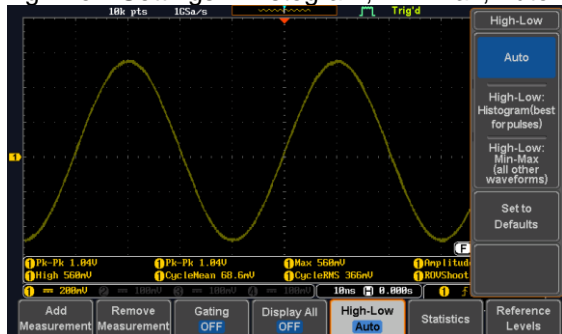

Restore Default High-Low Settings

To return to the default High-Low settings, press *Set to Defaults*.

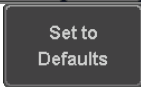



2-2-7. Statistics

Background

The Statistics function can be used to view a number of statistics for the selected automatic measurements. The following information is displayed with the Statistics function:

Value	Currently measured value
-------	--------------------------

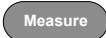
Mean	The mean value is calculated from a number of automatic measurement results. The number of samples used to determine the mean can be user-defined.
Min	The minimum value observed from a series of measured results for the selected automatic measurement items.
Max	The maximum value observed from a series of measured results for the selected automatic measurement items.
Standard Deviation	The variance of the currently measured value from the mean. The standard deviation equals the squared root of the variance value. Measuring the standard deviation can, for example, determine the severity of jitter in a signal. The number of samples used to determine the standard deviation can be user-defined.

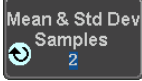
- Panel Operation
1. Press the *Measure* key. 
 2. Select at least one automatic measurement. Page 27
 3. Press *Statistics* from the bottom menu. 
 4. Set the number of samples to be used in the mean and standard deviation calculations. 

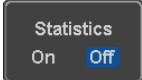
Samples: 2~1000
 5. Press *Statistics* and turn Statistics on. 
 6. The statistics for each automatic measurement will appear at the bottom of the display in a table.

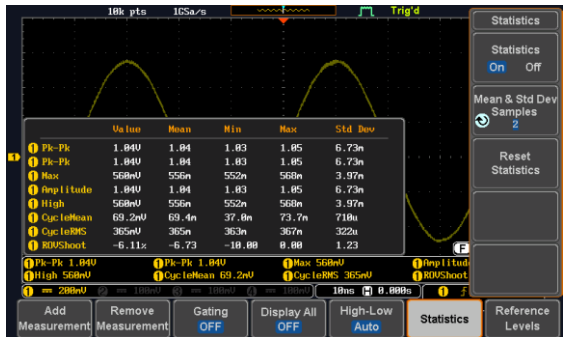

Reset Statistics To reset the standard deviation calculations, press *Reset Statistics*.



2-2-8. Reference Levels

Background The reference level settings determine the measurement threshold levels for some measurements like the Rise Time measurement.



High Ref: Sets the high reference level.



Mid Ref: Sets the middle reference for the first and second waveforms.

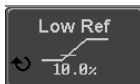

Low Ref: Sets the low reference level.

Panel Operation 1. Press the *Measure* key.

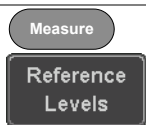

2. Press *Reference Levels* from the bottom menu.

3. Set the reference levels from the side menu. Ensure the reference levels do not cross over.

- High Ref 0.0% ~ 100%
- Mid Ref(1) 0.0% ~ 100%
- Mid Ref(2) 0.0% ~ 100%
- Low Ref 0.0% ~ 100%

Default Settings 4. Press *Set to Defaults* to set the reference levels back to the default settings.



2-3. Cursor Measurement

Horizontal or vertical cursors are used to show the position and values of waveform measurements and math operation results. These results cover voltage, time, frequency and other math operations. When the cursors (horizontal, vertical or both) are activated, they will be shown on the main display unless turned off.

2-3-1. Use Horizontal Cursors

Panel Operation 1. Press the *Cursor* key once.

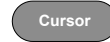

2. Press *H Cursor* from the bottom menu if it is not already selected.



3. When the H Cursor is selected, repeatedly pressing the *H Cursor* key or the *Select* key will toggle which cursor is selected.



OR



Range

Description



Left cursor (1) movable, right cursor position fixed



Right cursor (2) movable, left cursor position fixed



Left and right cursor (1+2) movable together

4. The cursor position information appears on the top left hand side of the screen

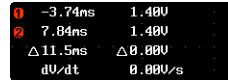

Cursor 1

Hor. position, Voltage/Current

Cursor 2

Hor. position, Voltage/Current

△

Delta (difference between cursors)
dV/dt or dI/dt

5. Use the *Variable* knob to move the movable cursor(s) left or right.

VARIABLE

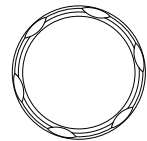

Select Units

6. To change the units of the horizontal position, press *H Unit*.

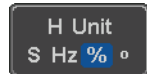

Units

S, Hz, % (ratio), °(phase)

Phase or Ratio Reference

- To set the 0% and 100% ratio or the 0° and 360° phase references for the current cursor positions, press *Set Cursor Positions As 100%*.

Set Cursor Positions As 100%

Example

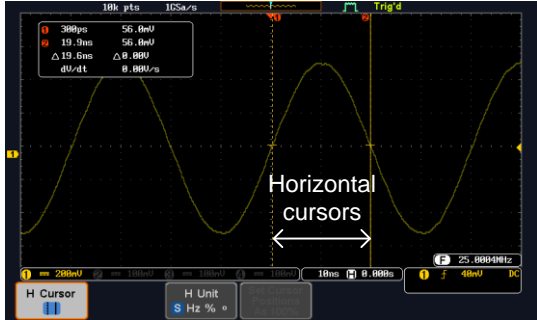

FFT

FFT cursors can use different units. For FFT details, see page 41.

1	1.0175GHz	21.2dB
2	2.2700GHz	-51.4dB
Δ	1.2525GHz	Δ72.6dB
d/dt		-58.0ndB/Hz

- Cursor 1 Hor. position, dB/Voltage
- Cursor 2 Hor. Position, dB/Voltage
- Δ Delta (difference between cursors) dV/dt or d/dt

Example

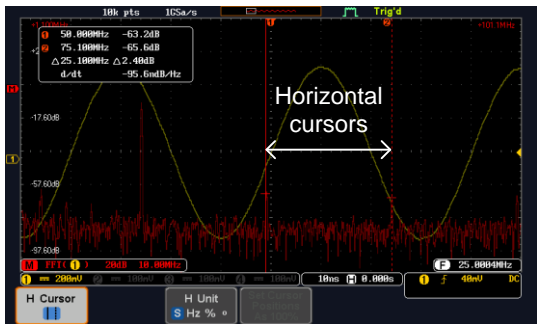

XY Mode

XY mode cursors measure a number of X by Y measurements.

1 (X) Versus 2 (Y)	1 2 Δ			
	t:	-625us	625us	1.25ns
Rectangular 	x:	16.0U	17.6U	1.68U
	y:	1.76U	-1.44U	-3.20U
Polar 	r:	16.0U	17.6U	3.57U
	θ:	6.27°	-4.67°	-63.4°
Product 	x×y:	28.10U	-25.30U	-5.12U
Ratio	y÷x:	110nU/U	-81.8nU/U	-2.00U/U

Cursor 1 Time, rectangular, polar coordinates, product, ratio.

Cursor 2 Time, rectangular, polar coordinates, product, ratio.

Δ Delta (difference between cursors)
Horizontal cursors

Example

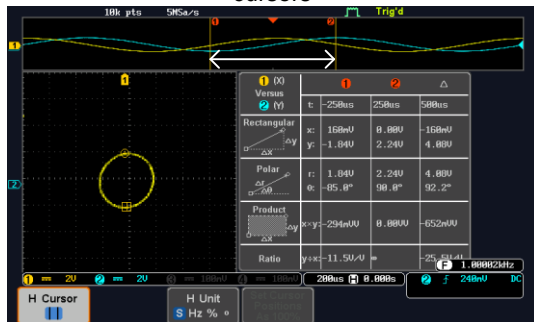

2-3-2. Use Vertical Cursors

Panel Operation/ Range 1. Press the *Cursor* key twice.

2. Press *V Cursor* from the bottom menu if it is not already selected.

3. When the *V Cursor* is selected, repeatedly pressing the *V Cursor* key or the *Select* key will toggle which vertical cursor is selected.

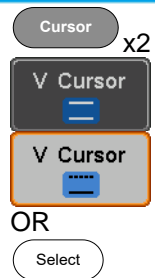

Range

- Upper cursor movable, lower cursor position fixed
- Lower cursor movable, upper cursor position fixed
- Upper and lower cursor movable together

4. The cursor position information appears on the top left hand side of the screen.

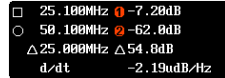

- , ○ Time: cursor 1, cursor 2
- 1, 2 Voltage/Current: cursor1, cursor2
- △ Delta (difference between cursors) dV/dt or dI/dt

5. Use the *Variable* knob to move the cursor(s) up or down.

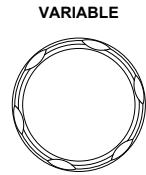

Select Units

6. To change the units of the vertical position, press *V Unit*.

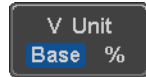

Base (source wave units), %
(ratio)

Base or Ratio Reference

7. To set the 0% and 100% ratio references for the current cursor position, press *Set Cursor Positions As 100%*.



Example

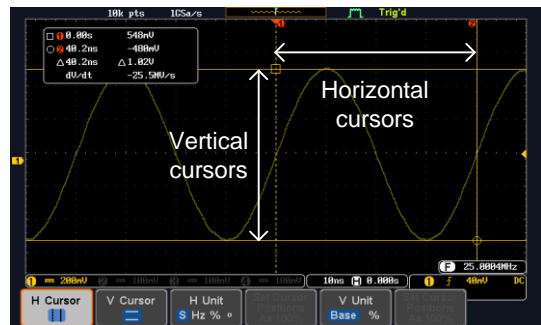

FFT

FFT has different content. For FFT details, see page 41.

25.100MHz **1** -7.20dB
 50.100MHz **2** -62.8dB
 25.000MHz Δ 54.8dB
 d/dt -2.19udB/Hz

- ,
- 1**, **2**
- Δ
- d/dt

Frequency/Time: cursor1, cursor2
 dB/V: cursor1, cursor2
 Delta (difference between cursors)

Example

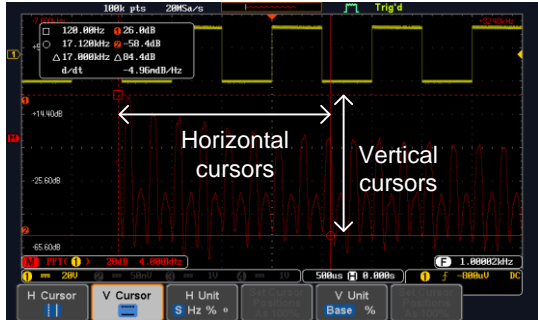

XY Mode

XY mode cursors measure a number of X by Y measurements.

1 (X) Versus 2 (Y)	1 2 Δ		
	t:	-625us	625us
Rectangular 	x: 18.4U y: -1.44U	-14.4U -1.68U	-32.8U -240mV
Polar 	r: 18.4U θ: -4.47°	14.4U -173°	32.8U -179°
Product 	x×y: -26.4UU	24.1UU	7.87UU
Ratio	y÷x: -78.2mU/U	116mU/U	7.31mU/U

Cursor **1** Rectangular, polar co-ordinates, product, ratio.

Cursor **2** Rectangular, polar co-ordinates, product, ratio.

Δ Delta (difference between cursors)

Example

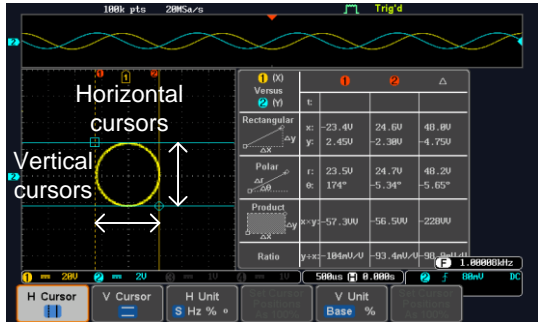

2-4. Math Operation

2-4-1. Basic Math Overview & Operators

Background The Math function performs basic math functions (addition, subtraction, multiplication, division) on the input signals or the reference waveforms. The resultant waveform will be shown on the screen in real-time.

Addition (+) Adds the amplitude of two signals.
Source CH1~4, Ref1~4

Subtraction (-) Extracts the amplitude difference between two signals.
Source CH1~4, Ref1~4

Multiplication (x) Multiplies the amplitude of two signals.
Source CH1~4, Ref1~4

Division (÷) Divides the amplitude of two signals.
Source CH1~4, Ref1~4

2-4-1-1. Addition/Subtraction/Multiplication/Division

Panel Operation 1. Press the *Math* key.

MATH



2. Press the *Math* key on the lower bezel.

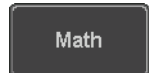

3. Select *Source 1* from the side menu



Range CH1~4, Ref1~4

4. Press *Operator* to choose the math operation.

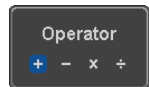

Range +, -, x, ÷

5. Select *Source 2* from the side menu.



Range CH1~4, Ref1~4

6. The math measurement result appears on the display. The vertical scale of the math waveform appears at the bottom of the screen.



From left: Math function, source1, operator, source2, Unit/div

Example

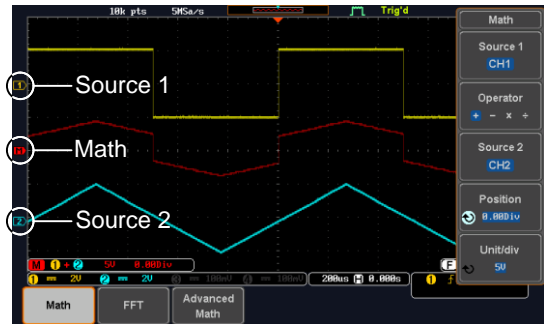

Position and Unit

To move the math waveform vertically, press the *Position* key from the side menu and use the *Variable* knob to set the position.



Range -12.00 Div ~ +12.00 Div

To change the unit/div settings, press *Unit/div*, then use the *Variable* knob to change the unit/div.

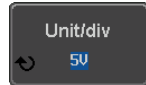

The units that are displayed depend on which operator has been selected, and whether the probe for the selected channel has been set to voltage or current.

Operator:	Unit/div:
Multiplication	VV, AA or W
Division	V/V, A/A
Addition/Subtraction	V or A

Turn Off Math

To turn off the Math result from the display, press the *Math* key again.



2-4-2. FFT Overview & Window Functions

Background	The FFT Math function performs a Fast Fourier Transform on one of the input signals or the reference waveforms. The resultant spectrum will be shown on the screen in real-time. Four types of FFT windows are available: Hanning, Hamming, Rectangular, and Blackman, as described below.	
Hanning FFT Window	Frequency resolution Amplitude resolution Suitable for....	Good Not good Frequency measurement on periodic waveforms
Hamming FFT Window	Frequency resolution Amplitude resolution Suitable for....	Good Not good Frequency measurement on periodic waveforms
Rectangular FFT Window	Frequency resolution Amplitude resolution Suitable for....	Very good Bad Single-shot phenomenon (this mode is the same as having no window at all)
Blackman FFT Window	Frequency resolution Amplitude resolution Suitable for....	Bad Very good Amplitude measurement on periodic waveforms

2-4-2-1. FFT Operation

Panel Operation 1. Press the *Math* key.

MATH



2. Press *FFT* from the bottom menu.



3. Select the *Source* from the side menu.

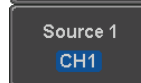

4. Press the *Vertical Units* key from the side menu to select the vertical units used.



Range CH1~4, Ref~4
Linear RMS, dBV RMS

- Press the *Window* key from the side menu and select the window type.

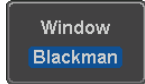

Range Hanning, Hamming, Rectangular, and Blackman.

- The FFT result appears. For FFT, the horizontal scale changes from time to frequency, and the vertical scale from voltage/current to dB/RMS.

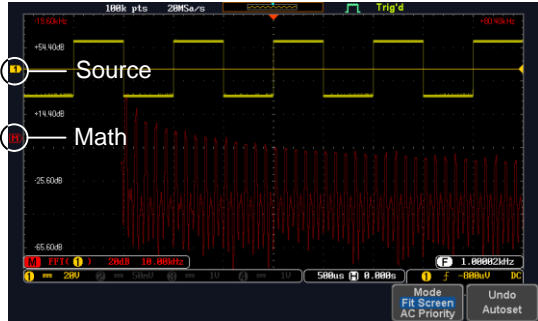

Position and Scale

To move the FFT waveform vertically, press *Vertical* until the *Div* parameter is highlighted and then use the Variable knob.



Range -12.00 Div ~ +12.00 Div

To select the vertical scale of the FFT waveform, press *Vertical* until the *dB* or *voltage* parameters are highlighted and then use the Variable knob.

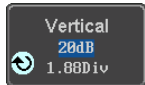

Range 2mV~1kV RMS, 1~20 dB

Horizontal Position and Scale

To move the FFT waveform horizontally, press *Horizontal* until the *Frequency* parameter is highlighted and then use the Variable knob.



Range 0Hz ~ 2.5MHz

To select the horizontal scale of the FFT waveform, press *Horizontal* repeatedly until the *Hz/div* parameter is highlighted and then use the Variable knob.

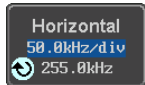

Range 10kHz/Div ~ 250kHz/Div

2-4-3. Advanced Math Overview

Background	<p>The advanced math function allows complex math expressions to be created based on the input sources, reference waveforms or even the automatic measurements available from the <i>Measure</i> menu (see page 24).</p> <p>An overview of each of the major parameters that can be used in the advanced math function are shown below:</p>
Expression	Displays the function expression as it is created.
Source	<p>Selects the source signal.</p> <p>Source CH1~4, Ref1~4</p>
Function	<p>Adds a mathematical function to the expression.</p> <p>Function Intg, Diff, log, Ln, Exp, Sqrt, Abs, Rad, Deg, Sin, Cos, Tan, Asin, Acos, Atan</p>
Variable	<p>Adds a user-specified variable to the expression.</p> <p>Source CH1~4, Ref1~4</p>
Operator	<p>Adds an operator or parenthesis to the function expression.</p> <p>Operator +, -, *, /, (,), !, <, >, <=, >=, ==, !=, , &&</p>
Figure	<p>Adds a value to the expression.</p> <p>Figure Integers, floating point, or floating point with exponent values.</p>
Measurement	<p>Adds automatic measurements to the expression. Not all automatic measurements are supported.</p> <p>Measurement Pk-Pk, Max, Min, Amp, High, Low, Mean, CycleMean, RMS, CycleRMS, Area, CycleArea, ROVShoot, FOVShoot, Freq, Period, Rise, Fall, PosWidth, NegWidth, Dutycycle, FRR, FRF, FFR, FFF, LRR, LRF, LFR, LFF, Phase, RPRFShoot, FPRESshoot, +Pulses, -Pulses, +Edges, -Edges</p>

2-4-4. Advanced Math Operation

Panel Operation 1. Press the *Math* key.



2. Press *Advanced Math* from the bottom menu.

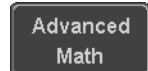

3. Press *Edit Expression*.

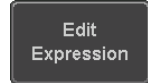

4. The Edit f(x) screen appears. CH1 + CH2 is shown in the expression box as an example at startup.

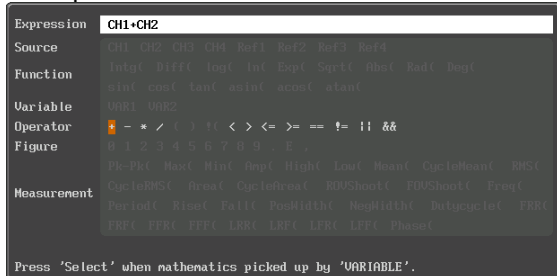

5. Press *Clear* to clear the expression entry area.

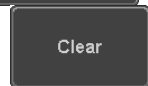

6. Use the *Variable* knob and *Select* key to create an expression.

VARIABLE

Use the *Variable* knob to highlight a source, function, variable, operator, figure or measurement in orange.

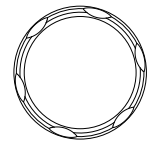

Press the *Select* key to make the selection.

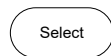

If a particular parameter is grayed out, it indicates that that particular parameter is not available at that time.

Back Space

1. To delete the last parameter press *Back Space*.



2. When the expression is complete, press *OK Accept*.

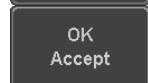

Example:
CH1 + CH2

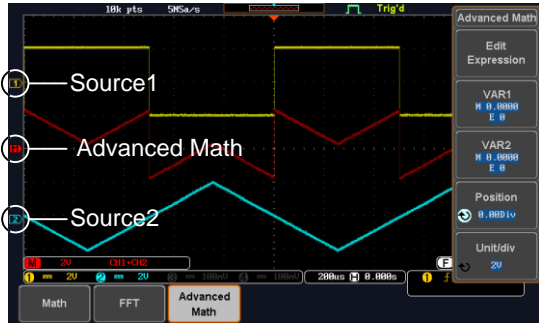

Set the VAR1 & VAR2

1. Press *VAR1* or *VAR2* to set VAR1/VAR2 if they were used in the expression created previously.
2. Press *Mantissa*. Use the *Left* and *Right* arrow keys to select a digit and use the variable knob to set the value of the selected digit.
3. Press *Exponent*. Use the Variable knob to set the exponent of the variable.
4. Press *Go Back* to finish editing VAR1 or VAR2.



Vertical Position and Scale

1. Press *Unit/div* and use the Variable knob to set the vertical scale of the math waveform.
2. Press *Position* and use the Variable knob to set the vertical position of the math waveform on the display.



Clear Advanced Math

To clear the advanced math result from the display, press the *Math* key again.

MATH



3. CONFIGURATION

3-1. Acquisition

The Acquisition process samples the analog input signals and converts them into digital format for internal processing.

3-1-1. Select Acquisition Mode

Background	The acquisition mode determines how the samples are used to reconstruct a waveform.
Sample	This is the default acquisition mode. Every sample from each acquisition is used.
Peak detect	Only the minimum and maximum value pairs for each acquisition interval (bucket) are used. This mode is useful for catching abnormal glitches in the signal.
Average	Multiple acquired data is averaged. This mode is useful for drawing a noise-free waveform. To select the average number, use the Variable knob. Average number: 2, 4, 8, 16, 32, 64, 128, 256

- Panel Operation
1. Press the *Acquire* key.
 2. To set the Acquisition mode, press *Mode* on the bottom menu.
 3. Select an acquisition mode from the side menu.
 4. If *Average* was chosen, set the number of samples to be used for the average function.
- | | |
|----------------|-------------------------------|
| Mode | Sample, Peak Detect, Average |
| Average sample | 2, 4, 8, 16, 32, 64, 128, 256 |

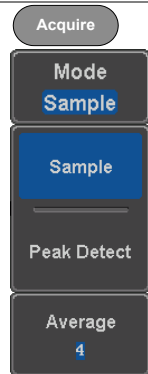

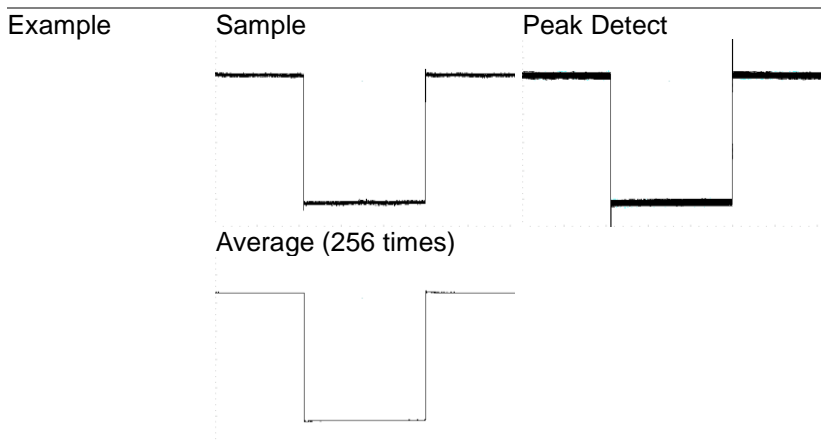

3-1-2. Show Waveform in XY Mode

Background The XY mode maps the input of channel 1 to the input of channel 2. In 4 channel models, the input of channel 3 can be mapped to the input of channel 4. This mode is useful for observing the phase relationship between waveforms.

Connection

1. Connect the signals to Channel 1 (X-axis) and Channel 2 (Y-axis) or Channel 3 (X2-axis) and Channel 4 (Y2-axis).
2. Make sure a channel pair is active (CH1&CH2 or CH3&CH4). Press the Channel key if necessary. A channel is active if the channel key is lit.

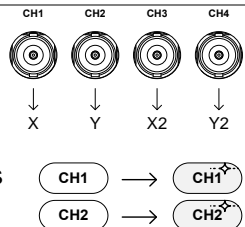

Panel Operation

3. Press the *Acquire* menu key.
4. Press *XY* from the bottom menu.
5. Choose *Triggered XY* from the side menu.

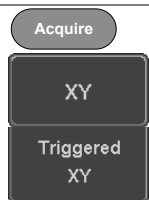

X-Y mode is split into two windows. The top window shows the signals over the full time range. The bottom window shows XY mode.

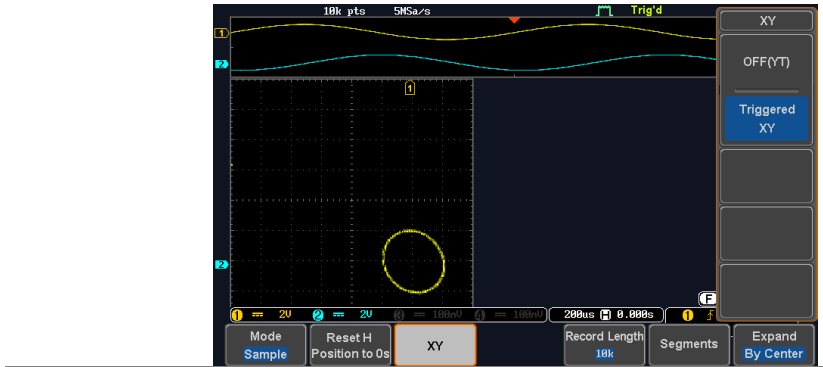

To move the X Y waveform position, use the vertical position knob: Channel 1 knob moves the X Y waveform horizontally, Channel 2 knob moves the X Y waveform vertically. Similarly, the X2 and Y2 axis can be positioned using the channel 3 and channel 4 vertical position knobs.

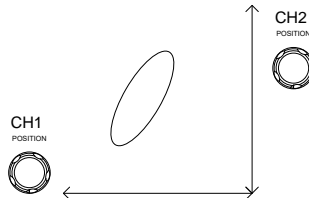

The horizontal position knob and horizontal Scale knob can still be used under the XY mode.

Turn Off XY Mode	To turn off XY mode, choose <i>OFF (YT)</i> mode.	OFF(YT)
------------------	---	----------------

Cursors and XY Mode Cursors can be used with XY mode. Page 33
See the Cursor chapter for details.

3-1-3. Set the Record Length

Background

The number of samples that can be stored is set by the record length. Record length is important in an oscilloscope as it allows longer waveforms to be recorded.

The maximum record length for the DCS-1000B depends on operating mode. The table below describes the record lengths that are available for each mode.

Limitations

Record Length	Normal	Zoom	FFT	FFT in Zoom Window
1k	✓	✗	✓	✗
10k	✓	✓	✓	✓
100k	✓	✓	✓	✓
1M	✓	✓	✓	✗
10M	✓	✓	✗	✗

Panel Operation 1. Press the *Acquire* key.



2. Press the *Record Length* key on the bottom menu and choose the record length.

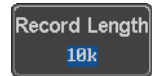

Record length 1000, 10k, 100k, 1M, 10M points



The sampling rate may also be changed when the record length is changed.

3-2. Segmented Memory Acquisition (Option)

The advanced segmented memory utility allows the scope memory to be divided into different segments. Each time the scope is triggered, it only acquires data for one segment of memory at a time. This allows you to optimize the scope memory to only perform signal acquisition during important signal events.

For example, for a signal with a number of pulses, normally the oscilloscope will acquire the signal until the acquisition memory of the scope is filled up and then it will re-arm the trigger and then capture again. This could result in a number of events not being captured or captured at a less-than-desired resolution (depending on the horizontal scale and sampling rate). However, the segmented memory function would effectively allow you to capture more of the

signal than you would otherwise. The diagrams below illustrate this point.

Normal acquisition mode example:

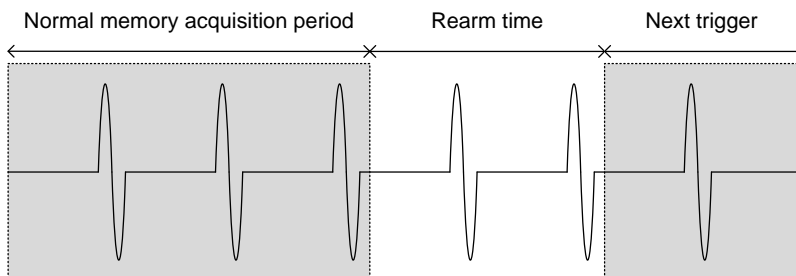

Segmented memory acquisition example:

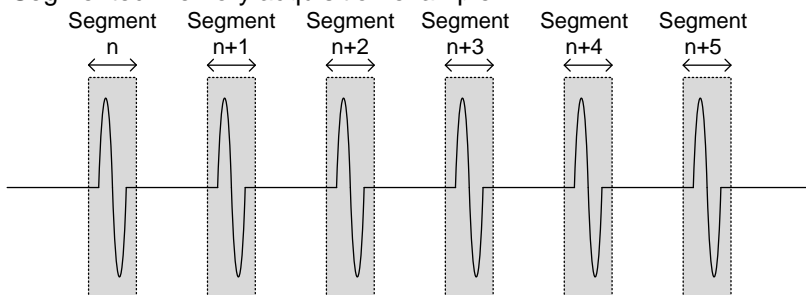

As shown above, the memory is divided into segments to increase the number of events that can be effectively captured with the same acquisition memory. Also notice that the scope doesn't need to rearm the trigger between each segment, this makes the segmented memory function especially useful for high speed signals. The time between each segment is also recorded so that accurate signal timing can also be measured.

The segmented memory function also supports automatic measurements for each segment or statistics for all the captured segments.

3-2-1. Segments Display

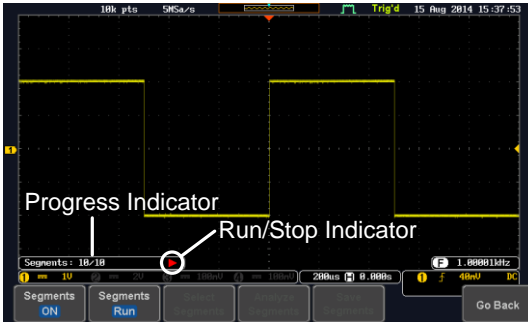

Progress Indicator

Segments : 10/10



Indicates the number of segments that have to be captured relative to the set number of segments.

Run/Stop Indicator



Stop: The segments have finished acquiring or have been stopped.



Run: The scope is ready to acquire segments.

3-2-2. Set the Number of Segments

Note

Before the Segment function can be used, set the trigger settings as appropriate for the signal you wish to use. The number of segments that can be used depends wholly on the record length. See page 49 to set the record length.

Record length	Number of segments
1000 pt.	1 ~ 29000
10k pt.	1 ~ 2900
100k pt.	1 ~ 290
1M pt.	1 ~ 20
10M pt.	1 ~ 2

Panel Operation

1. Press the *Acquire* key.
2. Press *Segments* on the bottom menu.
3. Press *Select Segments* and set the number of segments from the side menu.

Acquire

Segments

Select Segments

Num of Seg	1~29000 (record length dependant)
Set to Maximum	Sets to the maximum number
Set to Minimum	Sets to 1 segment



Note

The Select Segments icon is only available when when Segments = OFF or when Segments is in the STOP mode (see the section below).

3-2-3. Run Segmented Memory

Background

Before the Segmented Memory function can be used, set the trigger settings as appropriate for the signal you wish to use. See page 89 for configuring the trigger settings.

Run Segments

1. Toggle *Segments On* from the bottom menu.



2. Toggle *Segments Run* from the bottom menu.



3. The scope will automatically start acquiring segments. The progress of the segmented memory capture is shown in the Progress Indicator.

4. The Run Indicator will be shown when in the Run mode and the Segments icon will also indicate that the function is in run mode.

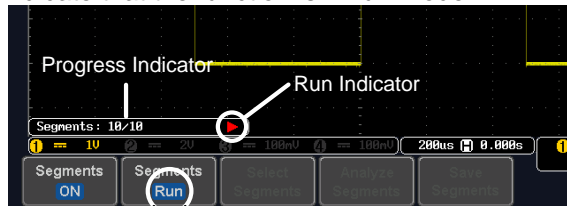

Segment (Run) icon

5. When the scope has finished acquiring segments, press *Segments Run* to toggle the mode to the *Segments Stop* mode.



Alternatively, the *Run/Stop* key can be pressed.



- The Stop Indicator will be shown when in the Stop mode.

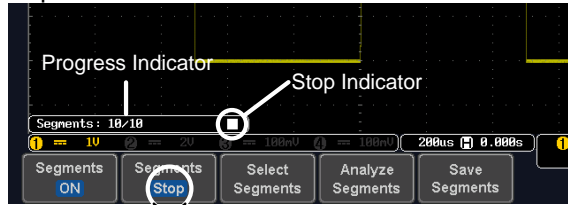

Segment (Stop) icon

The scope is now ready to navigate or analyze the acquired segments.

Rerun
Segmented
Acquisition

- To rerun the segments, press the *Segments Stop* key to toggle the mode back to the *Segments Run* mode.



Alternatively, press the *Run/Stop* key again.

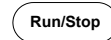

- Repeat steps 3 and 4 in the section above when the segmented acquisition has completed.

3-2-4. Navigate Segmented Memory

Background

After the segmented memory acquisitions have been captured you can navigate through each segment one at a time.

Operation

- Press *Select Segments* from the bottom menu. This key will be available in the Stop mode.
- To navigate to the segment of interest, press *Current Seg* from the side menu and use the Variable knob to scroll to the segment of interest.

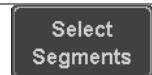

Alternatively, the *Set to Minimum* and *Set to Maximum* keys can be used to jump to the first and last segment respectively.

- The position in time of the selected segment relative to the time of the first segment is shown in the *Segments Time* key.

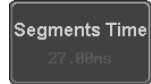

3-2-5. Play Through Each Segment

Background When all the segments have been acquired, the play/pause key can be used to play back through each segment.

- Operation**
- Make sure the scope is in *Segments Stop* mode. See page 52 for details.
 - Press the *Play/Pause* key to run through the acquired segments in numerical order.
 - Press the Play/Pause key again to pause the playback.
 - When the scope has played through to the last segment, pressing the Play/Pause key again will play through each segment again in reverse order.



3-2-6. Segment Measurement

Background The Segmented memory function can be used in conjunction with the automatic measurements in the Measurement menu.

Modes	Segments Measure	This function will either perform statistics calculations on the segments or tabulate a list of the measurement results.
	Segments Info	Provides configuration information common for all the acquired memory segments.

3-2-7. Automatic Measurement

Background The Segments Measure function allows you to view automatic measurements for the segments in statistical bins or as a list displaying the result of each automatic measurement.

	<p>Statistics</p> <p>Measurement List</p>	<p>This function will bin the measurement results of a single automatic measurement into a user-defined number of bins. This allows you to easily view statistics for a large number of segments. For example, the statistics function will display the number of results for each bin and the measurement range of each bin for the selected automatic measurement.</p> <p>Puts all the measurement results for a segment in a list. All the currently selected automatic measurement results are listed. A maximum of 8 automatic measurements can be used with this function.</p>
<p>Note</p>	<p>To use automatic measurements with the segmented memory, automatic measurements must first be selected from the Measure menu before the segmented memory function is run.</p>	
<p>Setup</p>	<p>Press the <i>Measure</i> key and select any <i>single</i> source measurement from the <i>Add Measurement</i> menu.</p> <p>See page 27 for details on how to add automatic measurements.</p>	
<p>Operation</p>	<ol style="list-style-type: none"> 1. Press <i>Analyze Segments</i> from the Segments menu. 2. Press <i>Segments Measure</i>. 3. Select either the statistics or the measurement list from the side menu. 	

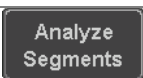

Statistics



List

4. The statics table or measurement list appears on the display.

Note that the more segments that you have, the longer it will take to calculate the statics or list the measurement results.

5. For statistic measurements, press *Plot Source* to choose which automatic measurement to use for the statistics calculations. The statistics for only one automatic measurement can be viewed at a time.



6. For the measurement list, press *Source* and select the source channel for measurement.
Range CH1 ~ CH4



Statistics Results

This function will bin the measurement results of the selected automatic measurement into a user-defined number of bins.

Setup

1. To select the number of bins for the statistics, press *Divided by* and select the number of bins with the Variable knob.

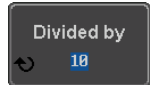

Range 1~20 bins

2. Press *Select* and use the Variable knob to view the measurement results for each bin.

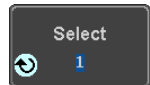

Example: Statistics

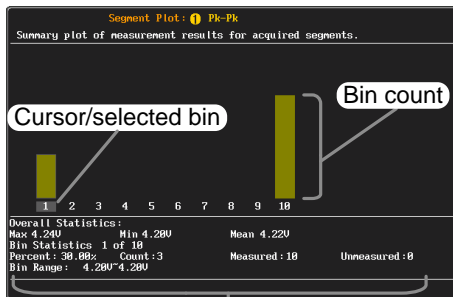

Statistics of currently selected bin

Measurement List

Puts all the measurement results for a segment in a list.

Setup

1. Press *Select* and use the variable knob to scroll through each segment.



Example:
Measurement
List

Select
cursor

Segment Summary

View and examine measurement results for acquired segments.

Seg.	Fall PreShoot (s)	Rise PreShoot (s)	Pk-Pk (V)
1	0.00	0.97	4.24
2	0.00	0.97	4.24
3	0.00	0.97	4.24
4	0.00	0.97	4.24
5	0.00	0.97	4.24
6	0.00	0.97	4.24
7	0.00	0.97	4.24
8	0.00	0.97	4.24
9	0.00	0.97	4.24
10	0.00	0.97	4.24

Measurement types

Measurement results

Save

1. Press *Save Meas. to File* to save all measurement data to CSV file.



3-2-8. Segment Info

Operation

1. Press *Analyze Segments* from the bottom menu.

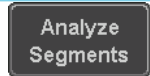

Note: This key will only be available in the Stop mode.

2. Press *Segments Info*.

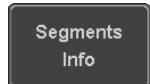

3. A table showing all general setting information for the segmented memory acquisitions is shown on the display.

Info: Sample rate, Record length,
Horizontal, Vertical

DSO Segmented Info.

Samplerate: 1GSa/s
Record Length: 1000 points
Horizontal: 0.000s @ 200ns/div
Vertical: 80.000mV @ 1V/div

3-2-9. Save Segment

Background Segments waveform data can be saved in CSV format by specifying a section.

Operation

1. Press Save Segment from the bottom menu.

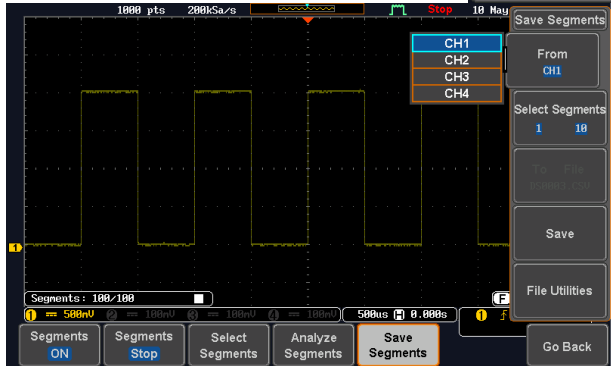

2. Press *From* key and Select channel.
3. Press *Select Segment*.

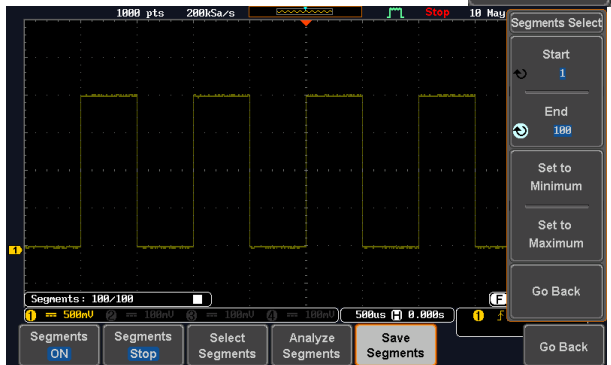

4. Press *Start* from the side menu and use the Variable knob to scroll to the segment of Start.
5. Press *End* from the side menu and use the Variable knob to scroll to the segment of End.



6. Press *Go Back* to return to the previous menu.
7. Press *Save* to save the file.



8. To edit the filename, use the *Variable* knob to highlight a character.



Press *Enter Character* or the *Select* key to select a number or letter.

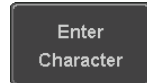

Press *Back Space* to delete a character.



9. Press *Save Now* to save the file. The filename need not have been edited to save the file.

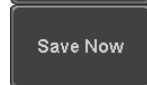

10. There are two types of waveform data, Fast CSV format and Detail CSV format . Please switch as necessary. (See 5-3-3.) If LSF format is selected, it is saved with Detail CSV format.

3-3. Display

The Display menu defines how the waveforms and parameters appear on the main LCD display.

3-3-1. Display Waveform as Dots or Vectors

Background When the waveform is displayed on the screen, it can be displayed as dots or vectors.

Panel Operation

1. Press the *Display* menu key.
2. Press *Dot / Vector* to toggle between Dot and Vector mode.



Range

Dots	Only the sampled dots are displayed.
Vectors	Both the sampled dots and the connecting line are displayed.

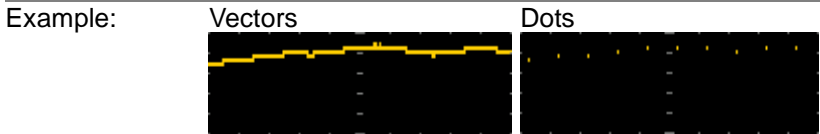

3-3-2. Set the Level of Persistence

Background The persistence function allows the DCS-1000B to mimic the trace of a traditional analog oscilloscope. A waveform trace can be configured to “persist” for a designated amount of time.

Panel Operation

1. Press the *Display* menu key.
2. To set the persistence time, press the *Persistence* menu button on the bottom bezel.
3. Use the Variable knob to select a persistence time.

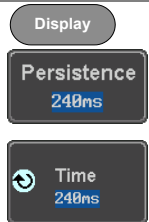



Time 16ms, 30ms, 60ms, 120ms, 240ms, 0.5s, 1s, 2s, ~4s, Infinite, Off

Clear To clear persistence, press *Clear Persistence*.



3-3-3. Set the Intensity Level

Background The intensity level of a signal can also be set to mimic the intensity of an analog oscilloscope by setting the digital intensity level.

Panel Operation 1. Press the *Display* menu key.  2. Press *Intensity* from the bottom menu. 

Waveform Intensity 3. To set the waveform intensity, press *Waveform Intensity* and edit the intensity.
Range 0~100%

Example Waveform Intensity 50% Waveform Intensity 100%

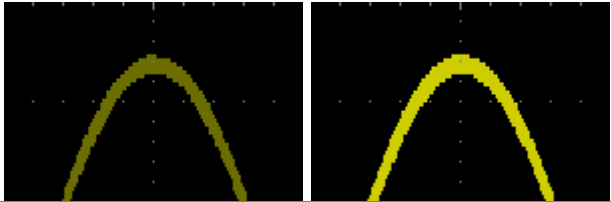

Graticule Intensity 4. To set the graticule intensity, press *Graticule Intensity* from the side menu and edit the intensity value.
Range 10~100%

Example Graticule Intensity 10% Graticule Intensity 100%

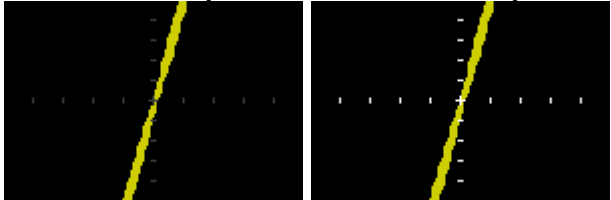

Backlight Intensity 5. To set the LCD backlight intensity, press *Backlight Intensity* from the side menu and edit the intensity value.
Range 2~100%

Backlight Auto-Dim

- To automatically dim the backlight after a set duration, set *Backlight Auto-Dim* to On and then set *Time* to the appropriate time.
After the set amount of time with no panel activity, the screen will dim until a panel key is pressed again. This function will prolong the life of the LCD display.
Range 1~180 min

3-3-4. Select Display Graticule

Panel Operation 1. Press the *Display* menu key.



- Press *Graticule* from the bottom menu.



- From the side menu choose the graticule display type.



Full: Shows the full grid; X and Y axis for each division.



Grid: Show the full grid without the X and Y axis.



Cross Hair: Shows only the center X and Y frame.



Frame: Shows only the outer frame.

3-3-5. Freeze the Waveform (Run/Stop)

For more details about Run/Stop mode, see page 21.

- Panel Operation 1. Press the *Run/Stop* key. The *Run/Stop* key turns red and waveform acquisition is paused.

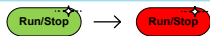

- The waveform and the trigger freezes. The trigger indicator on the top right of the display shows Stop.



- To unfreeze the waveform, press the *Run/Stop* key again. The *Run/Stop* key turns green again and acquisition resumes.

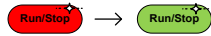

3-3-6. Turn Off Menu

- Panel Operation
- Press the *Menu Off* key below the side menu keys to reduce a menu. The menu key needs to be pressed each time to reduce one menu.

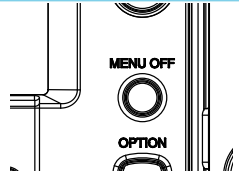

See page 14 for more information.

3-4. Horizontal View

This section describes how to set the horizontal scale, position, and waveform display mode.

3-4-1. Move Waveform Position Horizontally

- Panel Operation
- The horizontal position knob moves the waveform left/right. As the waveform moves, a position indicator on the top of the display indicates the horizontal position of the waveform in memory.

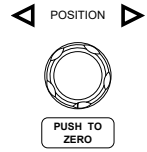

- Reset Horizontal Position
- To reset the horizontal position, press the *Acquire* key and then press *Reset H Position to 0s* from the bottom menu. Alternatively, pushing the horizontal position knob will also reset the position to zero.

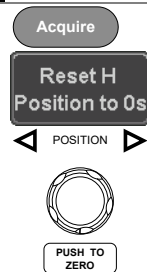

- Run Mode
- In Run mode, the memory bar keeps its relative position in the memory since the entire memory is continuously captured and updated.

3-4-2. Select Horizontal Scale

Select Horizontal Scale To select the timebase (time/div), turn the horizontal Scale knob; left (slow) or right (fast).

SCALE

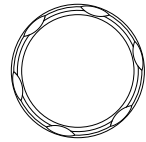

Range 5ns/div ~ 100s/div, 1-2-5 increment
The timebase indicator updates as the horizontal scale is adjusted.

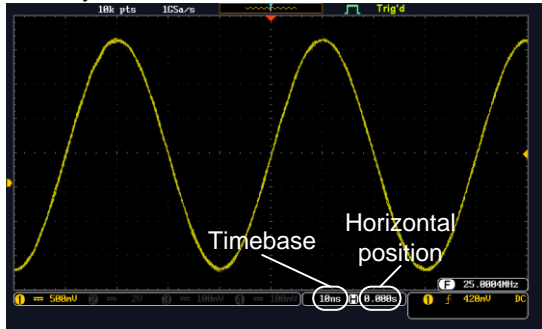

Run Mode In Run mode, the memory bar and waveform size keep their proportion. When the timebase becomes slower, roll mode is activated (if the trigger is set to Auto).

Stop Mode In Stop mode, the waveform size changes according to the scale.

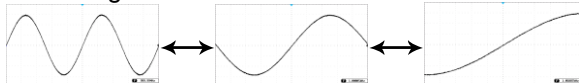

3-4-3. Select reference point of the horizontal expansion

Background The ability to change the center point of the horizontal expansion.

Panel Operation 1. press the Acquire key

Acquire

2. Press the Expand key and choose By Center or By Trigger Pos.

Expand
By Trigger Pos

3-4-4. Select Waveform Update Mode

Background	The display update mode is switched automatically or manually according to the timebase and trigger.
Normal	Updates the whole displayed waveform at once. Automatically selected when the timebase (sampling rate) is fast. Timebase $\leq 50\text{ms/div}$ Trigger all modes
Roll Mode	Roll Updates and moves the waveform gradually from the right side of the display to the left. Automatically selected when the timebase (sampling rate) is slow. Timebase $\geq 100\text{ms/div}$ Trigger all modes



Select Roll Mode Manually

1. Press the *Trigger Menu* key.
2. Press *Mode* from the bottom menu and select *Auto (Untriggered Roll)* from the side menu.



3-4-5. Zoom Waveform Horizontally

Background When in Zoom mode, the screen is split into 2 sections. The top of the display shows the full record length, while the bottom of the screen shows the normal view.

- Panel Operation
1. Press the *Zoom* key.
 2. The Zoom mode screen appears.



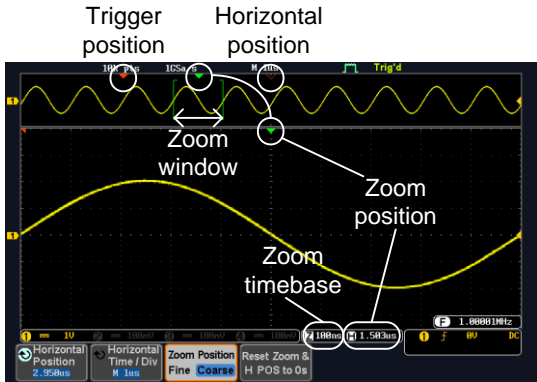

Horizontal Navigation

To scroll the waveform left or right, press *Horizontal Position* and use the *Variable Position* knob. The horizontal position will be shown on the *Horizontal Position* icon.



Horizontal Scale

To change the horizontal scale, press *Horizontal Time/Div* and use the *Variable Position* knob. The scale will be shown on the *Horizontal Time/Div* icon.



Zoom

To increase the zoom range, use the horizontal *Scale* knob. The zoom time base (Z) at the bottom of the screen will change accordingly.

SCALE

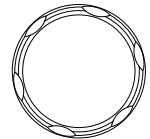

Move the Zoom Window

Use the *Horizontal Position* knob to pan the zoom window horizontally. To reset the zoom position, press the *Horizontal Position* knob.

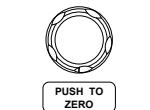
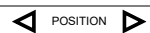

The position of the zoom window, relative to the horizontal position is shown at the bottom of the screen next to the Zoom timebase.







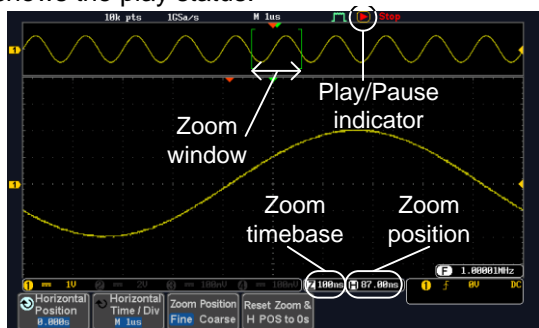

Scroll Sensitivity	To alter the scrolling sensitivity of the zoom window, press the <i>Zoom Position</i> key to toggle the scrolling sensitivity.	
Reset the Zoom & Horizontal Position	To reset both the zoom and horizontal position, press <i>Reset Zoom & H POS</i> to 0s.	
Exit	To go back to the original view, press the <i>Zoom</i> key again.	

Sensitivity Fine, Coarse

3-4-6. Play/Pause

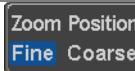
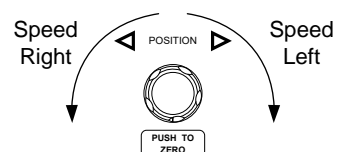
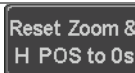
Background	The Play/Pause key can be used to play through signals in the Zoom mode.
Note	If the Segmented memory function is turned on, pressing the play pause key will play through memory segments. See page 54 for information.
Panel Operation	<ol style="list-style-type: none"> <li data-bbox="383 866 947 900">1. Press the <i>Play/Pause</i> menu key. <li data-bbox="383 914 992 1128">2. The scope will go into the Zoom Play mode and begin to scroll through the acquisition (from left to right). The full-record length waveform will be shown at the top and the zoomed section will be shown at the bottom. The Play/Pause indicator shows the play status.



Zoom	<p>To increase the zoom range, use the horizontal <i>Scale</i> knob.</p> <p>The zoom time base (Z) at the bottom of the screen will change accordingly.</p>	<p>SCALE</p> 
		
Scroll Speed	<p>To alter the scrolling speed of the zoom window, press the <i>Zoom Position</i> key to toggle the scrolling speed.</p> <p>Sensitivity Fine, Coarse</p> <p>Alternatively, use the horizontal position knob to control the scroll speed.</p> <ul style="list-style-type: none"> Turning the Horizontal knob determines the speed and direction of the scrolling. 	
		
Reset the Zoom Position	<p>To reset both the zoom position and horizontal position, press <i>Reset Zoom & H POS to 0s</i>.</p>	
Pause	<p>Press the <i>Play/Pause</i> key to pause or resume playing the waveform.</p>	
Reverse Direction	<p>Press the <i>Play/Pause</i> key when at the end of the record length to play back through the waveform in reverse.</p>	
Exit	<p>To exit, press the <i>Zoom</i> key.</p>	

3-5. Vertical View (Channel)

This section describes how to set the vertical scale, position, and coupling mode.

3-5-1. Move Waveform Position Vertically

Panel Operation 1. To move the waveform up or down, turn the *vertical position* knob for each channel.



2. As the waveform moves, the vertical position of the cursor appears at the bottom half of the display.

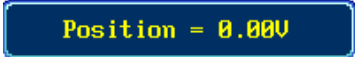

View or Set the Vertical Position

3. Press a channel key. The vertical position is shown in the \updownarrow Position / \downarrow Set to 0 soft key.



4. To change the position, press \updownarrow Position / \downarrow Set to 0 to reset the vertical position or turn the *vertical position* knob to the desired level.

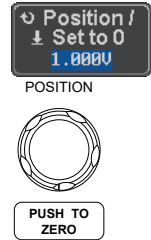

Run/Stop Mode The waveform can be moved vertically in both Run and Stop mode.

3-5-2. Select Vertical Scale

Panel Operation To change the vertical scale, turn the VOLT/DIV knob; left (down) or right (up).



The vertical scale indicator on the bottom left of the display changes accordingly for the specific channel.

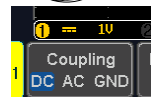

Range 1mV/div ~ 10V/div. 1-2-5 increments

Stop Mode In Stop mode, the vertical scale setting can be changed.

3-5-3. Select Coupling Mode

Panel Operation 1. Press a *channel* key.



2. Press *Coupling* repeatedly to toggle the coupling mode for the chosen channel.



Range



DC coupling mode. The whole portion (AC and DC) of the signal appears on the display.

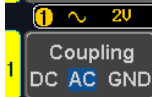

AC coupling mode. Only the AC portion of the signal appears on the display. This mode is useful for observing AC waveforms mixed with DC signals.



Ground coupling mode. The display shows only the zero voltage level as a horizontal line.

Example

Observing the AC portion of the waveform using AC coupling
DC coupling



AC coupling



3-5-4. Input Impedance

Background

The input impedance of the DCS-1000B is fixed at 1MΩ. The impedance is displayed in the channel menu.

View Impedance 1. Press the *Channel* key.



2. The impedance is displayed in the bottom menu.



3-5-5. Invert Waveform Vertically

Panel Operation 1. Press the *Channel* key.



2. Press *Invert* to toggle Invert On or Off.

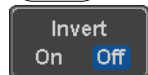

3-5-6. Limit Bandwidth

Background Bandwidth limitation puts the input signal into a selected bandwidth filter. This function is useful for cutting out high frequency noise to see a clear waveform shape. The bandwidth filters available are dependent on the bandwidth of the oscilloscope model.

- Panel Operation**
1. Press the *Channel* key.
 2. Press *Bandwidth* from the bottom menu.
 3. Choose a bandwidth* from the side menu.
- *Depending on the bandwidth of the oscilloscope.
Range 70MHz models: Full, 20MHz
100MHz models: Full, 20MHz

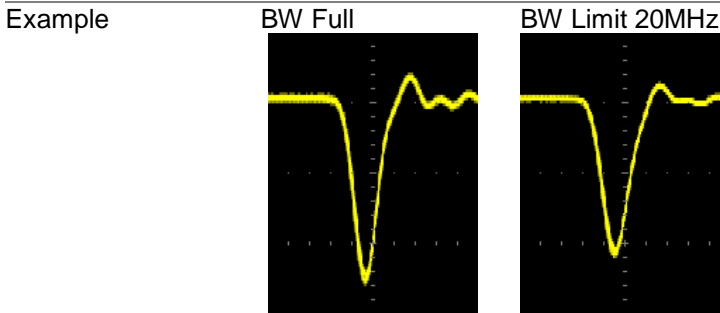

3-5-7. Expand by Ground/Center

Background When the voltage scale is changed, the Expand function designates whether the signal expands from the center of the screen or from the signal ground level. Expand by center can be used to easily see if a signal has a voltage bias. Expand by ground is the default setting.

- Panel Operation**
1. Press a *channel* key.
 2. Press *Expand* repeatedly to toggle between expand *By Ground* and *Center*.
- Range By Ground, By Center



Example

If the vertical scale is changed when the Expand function is set to ground, the signal will expand from the ground level*. The ground level does not change when the vertical scale is changed.
If the vertical scale is changed when the Expand function is set to center, the signal will expand from the center of the screen. The ground level will suit to match the signal position.
*Or from the upper or lower edge of the screen if the ground level is off-screen.

Expand by Ground

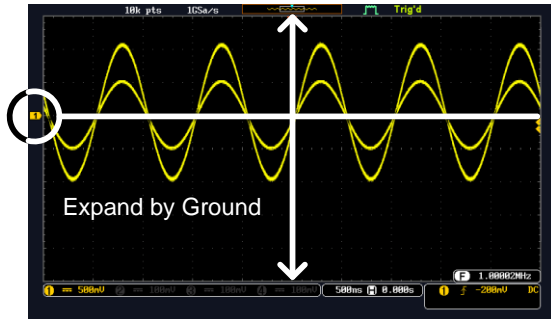

Expand by Center

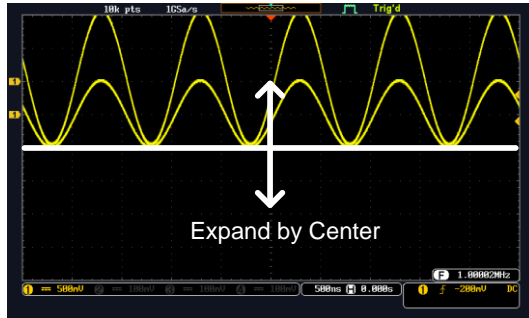

3-5-8. Select Probe Type

Background A signal probe can be set to voltage or current.

Panel Operation

1. Press the *Channel* key.
2. Press *Probe* from the bottom menu.
3. Press the *Voltage/Current* soft-key to toggle between voltage and current.

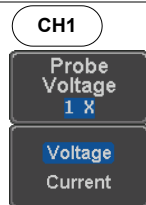

3-5-9. Select Probe Attenuation Level

Background An oscilloscope probe has an attenuation switch to lower the original DUT signal level to the oscilloscope input range, if necessary. The probe attenuation selection adjusts the vertical scale so that the voltage level on the display reflects the real value on a DUT.

- Panel Operation**
1. Press the *Channel* key.
 2. Press *Probe* from the bottom menu.
 3. Press *Attenuation* on the side menu and use the Variable knob to set the attenuation.
Alternatively, press *Set to 10X*.

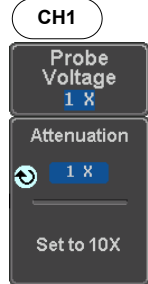

Range 1mX ~1kX (1-2-5 step)



Note

The attenuation factor adds no influence on the real signal. It just changes the voltage/current scale on the display.

3-5-10. Set the Deskew

Background The deskew function is used to compensate for the propagation delay between the oscilloscope and the probe.

- Panel Operation**
1. Press one of the *Channel* keys.
 2. Press *Probe* from the bottom menu.
 3. Press *Deskew* on the side menu and use the Variable knob to set the deskew time.
Alternatively, press *Set to 0s* to reset the deskew time.

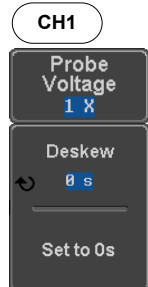

Range -50ns~50ns, 10ps increments

4. Repeat the procedure for another channel if necessary.

3-6. Bus Key Configuration

The Bus key is used to configure the Serial bus inputs. The Bus menu also features event tables to track and save your bus data. The Bus key is used in conjunction with the Bus trigger (page 102) to decode serial bus signals.

3-6-1. Bus Display

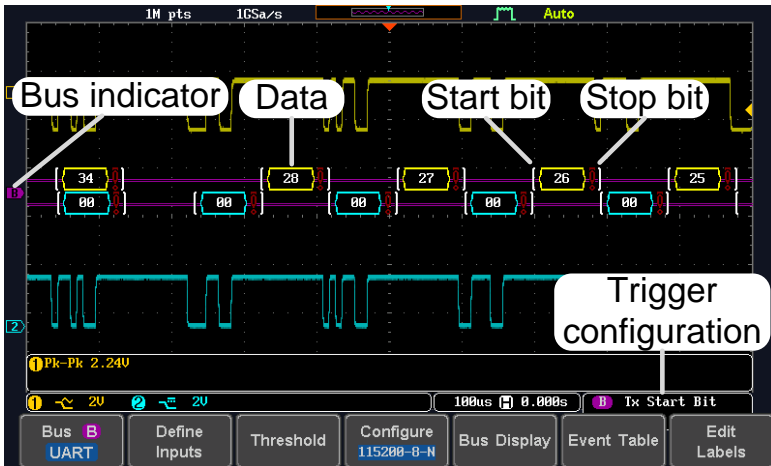

Start Bit/Start of Frame [The Start bit is shown as an open bracket.

Stop Bit/End of Frame] The Stop bit is shown as a closed bracket.

Data [F9 Data packets/frames can be shown in Hex or Binary. The color of the bus data indicates the type of data or the channel the data is coming from, depending on the bus type.

UART: Color of packet = Color of source channel.

I²C: Color packet = SDA source channel.

SPI: Color of packet = MOSI or MISO source channel.





CAN: Purple = Error frame, Data length control (DLC), Overload.

Yellow = Identifier.

Cyan = Data.

Orange = CRC.

Red = Bit stuffing error

		LIN: Purple = Break, Sync and Checksum errors, Wakeup Yellow = Identifier, Parity Cyan = Data Red = Error type
Error Indicator/ Missing Ack Bus Indicator		If there is an error/missing acknowledge in decoding the serial data, a red error indicator will be shown. The Bus indicator shows the bus position. The active bus is shown with a solid color. The Variable knob can be used to horizontally position the Bus indicator when it is active.
	 	Active bus (solid indicator) Activated bus (transparent indicator)
Trigger Configuration		Shows the bus trigger (B) and the <i>Trigger On</i> settings.
		

3-6-2. Serial Bus

The Serial Bus includes support for 5 common serial interfaces, SPI, UART, I²C, CAN and LIN. Each interface is fully configurable to accommodate variations in the basic protocols.

Each input can be displayed as binary, hexadecimal or ASCII. An event table can also be created to aid in debugging.

3-6-2-1. Serial Bus Overview

UART	Universal Asynchronous Receiver Transmitter. The UART bus is able to accommodate a wide range of various common UART serial communications. The UART serial bus software is suitable for a number of RS-232 protocol variants.
Inputs	Tx, Rx
Threshold	Tx, Rx
Configuration	Baud rate, Parity, Packets, End of packets, Input polarity
Trigger On	Tx Start Bit, Rx Start Bit, Tx End of Packet, Rx End of Packet, Tx Data, Rx Data, Tx Parity Error, Rx Parity Error
I ² C	Inter Integrated Circuit is a two line serial data interface with a serial data line (SDA) and serial clock line (SCLK). The R/W bit can be configured.
Inputs	SCLK, SDA

	<p>Threshold SCLK, SDA</p> <p>Configuration Addressing mode, Read/Write in address</p> <p>Trigger On Start, Repeat Start, Stop, Missing Ack, Address, Data, Address/Data</p>
SPI	<p>The SPI (Serial Interface Peripheral) bus is fully configurable to accommodate the wide variety of SPI interfaces. This bus is only available on 4 channel models.</p> <p>Inputs SCLK, SS, MOSI, MISO</p> <p>Threshold SCLK, SS, MOSI, MISO</p> <p>Configuration SCLK edge, SS logic level, Word size, Bit order</p> <p>Trigger On SS Active, MOSI, MISO, MOSI&MISO</p>
CAN	<p>The CAN (Controller Area Network) bus is a 2-wire, message-based protocol.</p> <p>Inputs CAN Input</p> <p>Threshold CAN Input</p> <p>Configuration Signal Type, Bit Rate</p> <p>Trigger On Start of Frame, Type of Frame, Identifier, Data, Id & Data, End of Frame, Missing Ack, Bit Stuffing Err.</p>
LIN	<p>The LIN (Local Interconnect Network) bus is used to decode a wide range of common LIN configurations.</p> <p>Inputs LIN Input</p> <p>Threshold LIN Input</p> <p>Configuration Bit Rate, LIN Standard, Include Parity Bits with Id</p> <p>Trigger On Sync, Identifier, Data, Id & Data, Wakeup Frame, Sleep Frame, Error</p>

3-6-2-2. UART Serial Bus Configuration

The UART bus menu is designed to decode RS-232 and other common RS-232 variants such as RS-422, RS-485. The software configuration is also flexible enough to decode the many proprietary protocols based on RS-232.

Background Basic RS-232 protocol uses single-ended data transmissions. The signal voltage levels can be high ($\pm 15V$) and employ active low signaling. High speed variants of RS-232, such as RS-422 and RS-485 use differential signaling and commonly employ low voltage differential signals with active high signaling. Universal Asynchronous Receiver/Transmitter (UART) or RS-232 driver/receiver ICs commonly used for embedded applications typically use active high signaling with standard IC signal levels.

Operation

1. Connect each of the bus signals (*Tx*, *Rx*) to one of the oscilloscope channels. Connect the ground potential of the bus to one of the probes' ground clip.

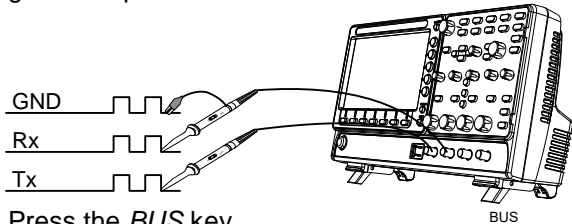

2. Press the *BUS* key.
3. Press *Bus B* from the bottom menu and choose the *UART* serial bus on the side menu.

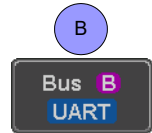

Define Inputs

1. Press *Define Inputs* from the bottom menu.
2. From the side menu choose the *Tx Input* and the *Rx Input* source and the signal polarity.

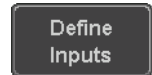

Tx OFF, CH1 ~ CH4
Rx OFF, CH1 ~ CH4

Polarity Normal (High = 0), Inverted (High = 1)

Configuration

The Configure key sets the baud rate, number of data bits and parity.

1. Press *Configure* from the bottom menu.



2. From the side menu select the *Baud rate*, *Data bits*, *Parity*, *Packets* and *End of Packet bits*.

Baud Rate 50, 75, 110, 134, 150, 300, 600, 1200, 1800, 2000, 2400, 3600, 4800, 7200, 9600, 14400, 15200, 19200, 28800, 31250, 38400, 56000, 57600, 76800, 115200, 128000, 230400, 460800, 921600, 1382400, 1843200, 2764800

Data Bits 8 (fixed)

Parity Odd, Even, None

Packets On, Off

End of Packet 00(NUL), 0A(LF), 0D(CR), 20(SP), FF (Hex)



3-6-2-3. I²C Serial Bus Interface

The I²C bus is a 2 wire interface with a serial data line (SDA) and serial clock line (SCLK). The I²C protocol supports 7 or 10 bit addressing and multiple masters. The scope will trigger on any of the following conditions: a start/stop condition, a restart, a missing acknowledge message, Address, Data or Address&Data frames.

The I²C trigger can be configured for 7 or 10 bit addressing with the option to ignore the R/W bit as well as triggering on a data value or a specific address and direction (read or write or both).

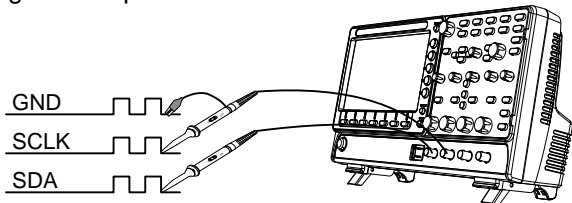
- Panel operation
1. Connect each of the bus signals (*SCLK*, *SDA*) to one of the oscilloscope channels. Connect the ground potential to one of the probes' ground clip.

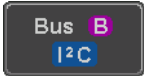

	2. Press the <i>Bus</i> key.	
	3. Press <i>Bus</i> from the bottom menu and choose <i>I²C</i> from the side menu.	
Define Inputs	1. Press <i>Define Inputs</i> from the bottom menu. 2. From the side menu choose the <i>SCLK</i> input and the <i>SDA</i> Input. <i>SCLK</i> CH1 ~ CH4 <i>SDA</i> CH1 ~ CH4	
Include R/W in address	To configure whether you want the R/W bit to be included in the address, press <i>Include R/W in address</i> and set to Yes or No in the side menu. R/W Bit Yes, No	

3-6-2-4. SPI Serial Bus Interface



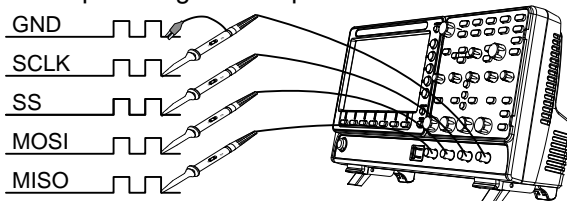

The serial peripheral interface (SPI) is a full duplex 4 wire synchronous serial interface. The 4 signals lines: Serial clock line (SCLK), slave select (SS), Master output/slave input (MOSI, or SIMO) and the Master input/slave output (MISO, or SOMI). The word size is configurable from 4 to 32 bits. The SPI triggers on the data pattern at the start of each framing period. Note: The SPI bus is only available for 4 channel models.

Panel operation 1. Connect each of the bus signals (*SCLK*, *SS*, *MOSI*, *MISO*) to one of the channel inputs. Connect the ground potential of the bus to one of the probes' ground clip.

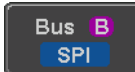

2. Press the *Bus* key.

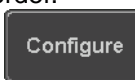

	3. Press <i>Bus</i> from the bottom menu and choose the <i>SPI</i> serial bus.	
Define Inputs	1. Press <i>Define Inputs</i> from the lower menu. 2. From the side menu choose the <i>SCLK</i> , <i>SS</i> , <i>MOSI</i> and <i>MISO</i> inputs. <i>SCLK</i> CH1 ~ CH4 <i>SS</i> CH1 ~ CH4 <i>MOSI</i> OFF, CH1 ~ CH4 <i>MISO</i> OFF, CH1 ~ CH4	
Configuration	The <i>Configure</i> menu sets the data line logic level, <i>SCLK</i> edge polarity, word size and bit order. 1. Press <i>Configure</i> from the bottom menu. 2. From the side menu select <i>SCLK</i> edge, <i>SS</i> logic level, word <i>Size</i> and <i>Bit</i> order. <i>SCLK</i> rising edge  , falling edge  <i>SS</i> Active High, Active Low <i>Word Size</i> 4 ~ 32 bits <i>Bit Order</i> MS First, LS First	

3-6-2-5. CAN Serial Bus Interface

The controller area network (CAN) bus is a half duplex 2 wire synchronous serial interface. The CAN bus is a multi-master communication system that relies on arbitration to solve contention issues. The DCS-1000B supports both CAN 2.0A and 2.0B. The CAN bus uses two wires, CAN-High and CAN-Low. These wires are voltage inverted, and as such, the DCS-1000B only needs one wire, CAN-High or CAN-Low for decoding.

- Panel operation 1. Connect the bus signal (*CAN Input*) to one of the channel inputs. Connect the ground potential of the bus to the probe's ground clip.

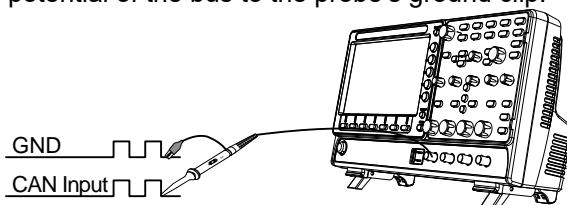

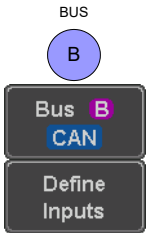
- | | | |
|---------------|--|---|
| Define Inputs | <ol style="list-style-type: none"> 2. Press the <i>Bus</i> key. 3. Press <i>Bus</i> from the bottom menu and choose the <i>CAN</i> serial bus. <ol style="list-style-type: none"> 1. Press <i>Define Inputs</i> from the lower menu. 2. From the side menu choose the <i>CAN Input</i> inputs and the signal type. <ul style="list-style-type: none"> CAN Input CH1 ~ CH4 Signal Type CAN_H, CAN_L, Tx, Rx. |  |
|---------------|--|---|

 Note	The <i>Sample Point</i> soft-key indicates the sampling position of each bit. This parameter is fixed.
--	--

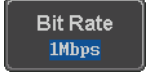
- | | | |
|----------|---|---|
| Bit Rate | <p>The <i>Bit Rate</i> menu sets the bit rate of the bus. The bit rate is usually tied to the bus length.</p> <ol style="list-style-type: none"> 3. Press <i>Bit Rate</i> from the bottom menu and set the bit rate. <p>Bit Rate 10kbps, 20kbps, 50kbps, 125kbps, 250kbps, 500kbps, 800kbps, 1Mbps</p> |  |
|----------|---|---|

3-6-2-6. LIN Serial Bus Interface

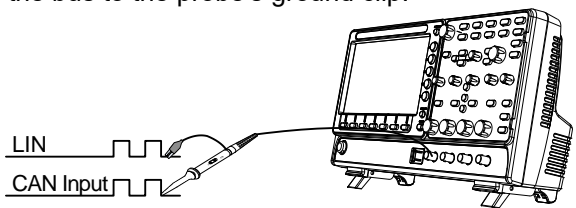

The local interconnect network (LIN) bus is a single wire interface.

- | | |
|-----------------|--|
| Panel operation | <ol style="list-style-type: none"> 1. Connect the bus signal (<i>LIN Input</i>) to one of the channel inputs. Connect the ground potential of the bus to the probe's ground clip. |
|-----------------|--|

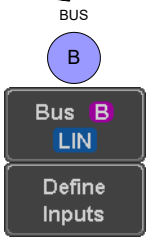

- | | | |
|---------------|---|---|
| Define Inputs | <ol style="list-style-type: none"> 2. Press the <i>Bus</i> key. 3. Press <i>Bus</i> from the bottom menu and choose the <i>LIN</i> serial bus. <ol style="list-style-type: none"> 1. Press <i>Define Inputs</i> from the lower menu. |  |
|---------------|---|---|

- From the side menu choose the LIN input and the polarity of the bus.
 LIN Input CH1 ~ CH4
 Polarity Normal (High = 1),
 Inverted(High = 0)

 Note	The <i>Sample Point</i> soft-key indicates the sampling position of each bit. This parameter is fixed.
Configuration	The <i>Configure</i> menu sets the bit rate, the LIN standard and the parity options for the Id frame. <ol style="list-style-type: none"> Press <i>Configure</i> from the bottom menu.  From the side menu select configuration items. Bit Rate 1.2kbps, 2.4kbps, 4.8kbps, 9.6kbps, 10.417kbps, 19.2kbps LIN Standard V1.x, V2.x, Both Include Parity On, Off Bits with Id

3-6-2-7. Bus Encoding

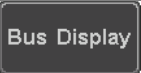
Background	The bus that is displayed on the screen or in the event tables can be set to either hex or binary formats.
Operation	Press <i>Bus Display</i> from the Bus menu and choose either Hex or Binary from the side menu. 

3-6-3. Threshold Configuration

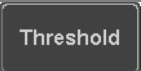
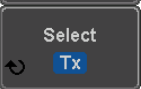
Background	The threshold levels for the Serial buses can be set to either a user-defined threshold level or to pre-set threshold.								
Set the Threshold	<ol style="list-style-type: none"> Press <i>Threshold</i> from the bottom menu.  Press <i>Select</i> from the side menu and choose a one of the serial bus lines.  <table data-bbox="431 1316 901 1437"> <tr> <td>UART</td> <td>Tx, Rx</td> </tr> <tr> <td>I²C</td> <td>SCLK, SDA</td> </tr> <tr> <td>SPI</td> <td>SCLK, SS, MOSI, MOSI</td> </tr> <tr> <td>CAN</td> <td>CAN_H, CAN_L, Tx, Rx</td> </tr> </table> 	UART	Tx, Rx	I ² C	SCLK, SDA	SPI	SCLK, SS, MOSI, MOSI	CAN	CAN_H, CAN_L, Tx, Rx
UART	Tx, Rx								
I ² C	SCLK, SDA								
SPI	SCLK, SS, MOSI, MOSI								
CAN	CAN_H, CAN_L, Tx, Rx								

- LIN LIN Input
3. Press *Choose Preset* to select a pre-set logic threshold.

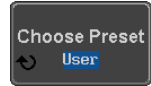

Logic Type	Threshold
TTL	1.4V
5.0V CMOS	2.5V
3.3V CMOS	1.65V
2.5V CMOS	1.25V
ECL	-1.3V
PECL	3.7V
0V	0V

4. Press *Threshold* to set a user defined threshold for the currently selected group. The threshold level depends on vertical scale.

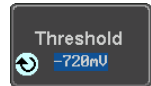

Scale	Range	Scale	Range
10V/Div	±290V	50mV/Div	±5.2V
5V/Div	±270V	20mV/Div	±580mV
2V/Div	±33V	10mV/Div	±540mV
1V/Div	±29V	5mV/Div	±520mV
500mV/Div	±27V	2mV/Div	±508mV
200mV/Div	±5.8V	1mV/Div	±504mV
100mV/Div	±5.4V		

3-6-3-1. Serial Bus Event Tables

Background

The serial bus event tables list when each data event on the bus occurred. The data is displayed as either hex or binary, depending on the bus display settings.

Event tables can be saved to disk in a CSV format. The files will be named "Event_TableXXXX.CSV", where XXXX is a number from 0000 to 9999. See page 86 for details.

Operation

1. Press *Event Table* from the bottom menu.
2. Press *Event Table* from the side menu to turn the event table on or off.

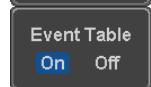
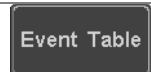

Event On, Off

Use the Variable knob to scroll through the event table.

Data Detail (I²C only)

- To view the data at a particular address in more detail, turn *Data Detail* On. This is only available for the I²C bus.

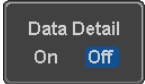

Detail On, Off

Use the Variable knob to scroll through the Data Detail event table.

Save Event Table

- To save the event table, press *Save Event Table*. The Event table will be saved to the current file path in a CSV format. See page 86 for details.



Use the variable knob to scroll through the event table.

Example: UART Event table

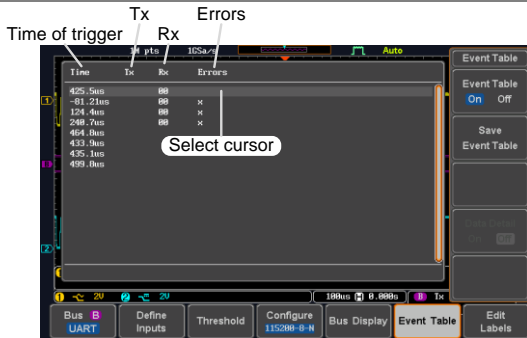

Example: I²C Event table

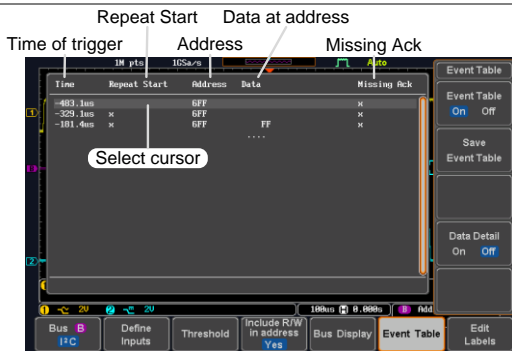

Example:
I²C Data Detail

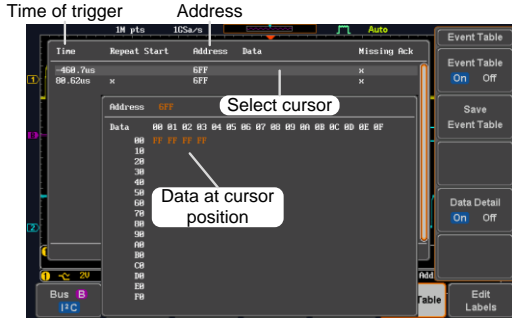

Note Data Detail is only available with the I²C bus.

Example:
SPI Event table

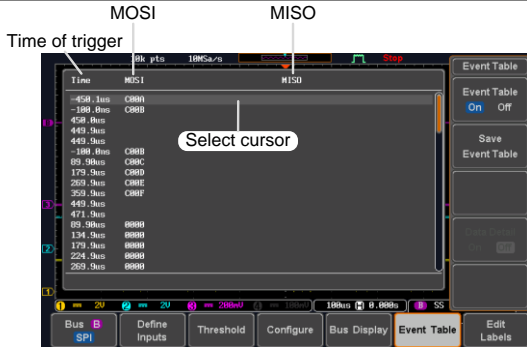

Example:
CAN Event table

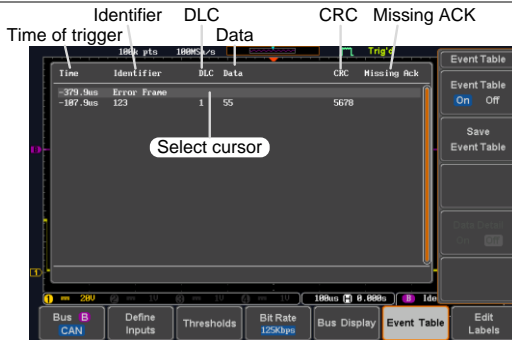

Example:
LIN Event table

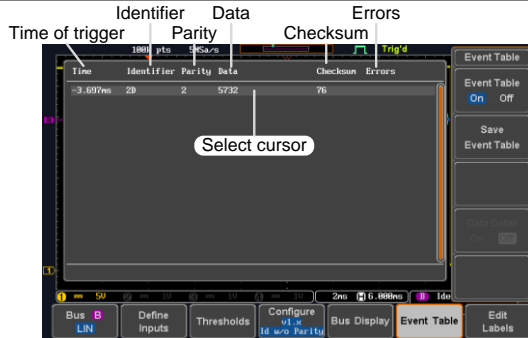

3-6-3-2. Event Tables Format

Each bus type (UART, I²C, CAN, LIN) can have an event table saved containing each bus event as a .CSV file. For serial buses, an event is defined as the data on the bus when a Stop or End of Packet (UART) is encountered. The data associated with each event and the time of each event is recorded.

File Type	Each event table is saved as Event_TableXXXX.CSV into the designated file path. Each event table is numbered sequentially from 0000 to 9999. For example the first event table will be saved as Event_Table0000.CSV, the second as Event_Table0001.CSV, and so on.
Event Table Data	Each event table saves a timestamp of each event relative to the trigger as well as the data in each frame/packet at the time of an event. The frame/packet data is saved in HEX format. The table below lists in order the data saved for each event table. UART Time, Tx frame data, Rx frame data, Errors. I ² C Time, Repeat Start, Address, Data, Missing Ack. SPI Time, MISO frame data, MOSI frame data. CAN Time, Identifier, DLC, Data, CRC, Missing Ack. LIN Time, Identifier, Parity, Data, Checksum, Errors.
Example	Below shows the data associated with an SPI event table in a spreadsheet.

Time	MOSI	MISO
-11.60us	0D87	0D87
-10.16us	06C0	06C0
-8.720us	8343	343
-7.282us	243	243
-5.840us	0C88	0C88

3-6-3-3. Adding a Label to the Serial Bus

Background A Label can be added to the serial buses. This label will appear next to the bus indicator on the left hand-side of the display.

- Panel Operation**
- To add a label to the bus, press *Edit Labels* from the Bus menu.
 - To choose a preset label, Press *User Preset* from the side menu and choose a label.



Labels ACK, AD0, ADDR, ANALOG, BIT, CAS, CLK, CLOCK, CLR, COUNT, DATA, DTACK, ENABLE, HALT, INT, IN, IRQ, LATCH, LOAD, NMI

- Edit Label**
- Press *Edit Character* to edit the current label.
 - The Edit Label window appears.

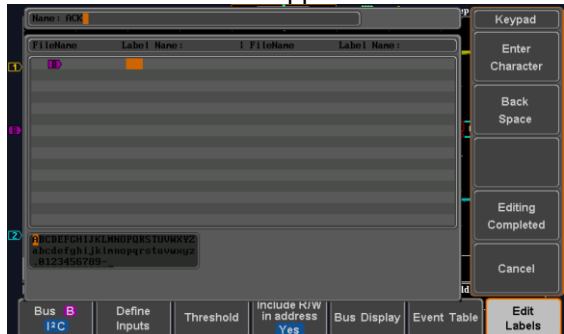
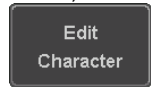

- Use the Variable knob to highlight a character.

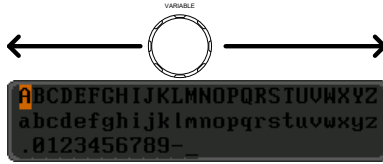

Press *Enter Character* to select a number or letter.

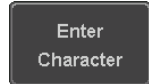

Press *Back Space* to delete a character.

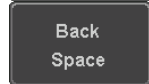

Press *Editing Completed* to create the new label and return to the previous menu.

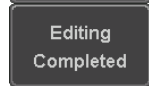

Note: this key must be pressed to save the label, even for the preset labels.

Press *Cancel* to cancel the editing and return to the Edit Label menu.

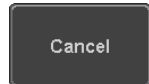

4. The label will appear next to the bus indicator. Below, the label "ACK" was created for the bus.



The bus is labeled as ACK

Remove Label Press *Label Display* to toggle the label on or off.

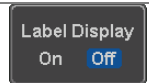

3-6-3-4. Using Cursors with the Serial Bus

Background The cursors can be used to read bus values at any position.

 **Note** Ensure that one of the serial buses has been selected and is activated.

Panel Operation

1. Press the *Cursor* key. Horizontal cursors appear on the display.
2. Press the *H Cursor* soft-key and select which cursor(s) you wish to position.

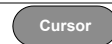

Range	Description
	Left cursor (1) movable, right cursor position fixed
	Right cursor (2) movable, left cursor position fixed
	Left and right cursor (1+2) movable together

3. The cursor position information appears on the top left hand side of the screen.

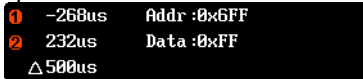

Example: I²C cursors.

Cursor 1 Hor. position, Bus value(s)

Cursor 2 Hor. position, Bus value(s)

4. Use the *Variable knob* to move the movable cursor(s) left or right.

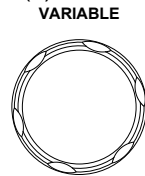

3-7. Trigger

The trigger configures the conditions for when the DCS-1000B captures a waveform.

3-7-1. Trigger Type Overview

Edge The edge trigger is the simplest trigger type. An edge trigger triggers when the signal crosses an amplitude threshold with either a positive or negative slope.

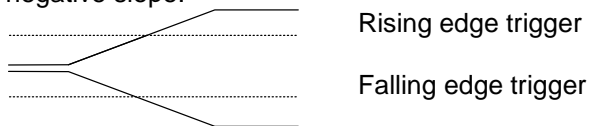

Delay The Delay trigger works in tandem with the edge trigger, by waiting for a specified time (duration) or number of events before the delay trigger starts. This method allows pinpointing a location in a long series of trigger events.

Note: when using the delay trigger, the edge trigger source can be any one of the channel inputs, the EXT* input or the AC line. *EXT only available on 2 channel models.

Delay trigger example (by event)

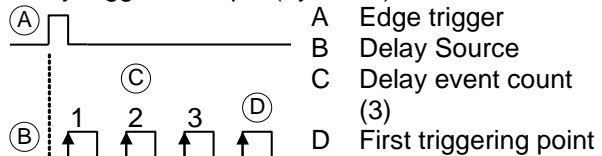

Delay trigger example (by time)

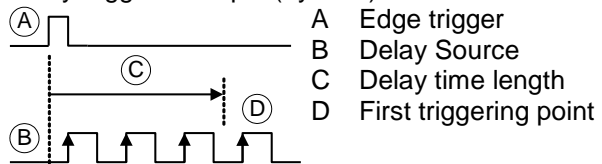

Pulse Width Triggers when the pulse width of the signal is less than, equal, not equal or greater than a specified pulse width.

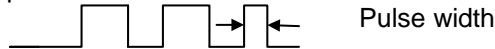

Video Extracts a sync pulse from a video format signal, and triggers on a specific line or field.

Pulse and Runt Triggers on a "runt". A runt is a pulse that passes a specified threshold but fails to pass a second threshold. Both positive and negative runts can be detected.

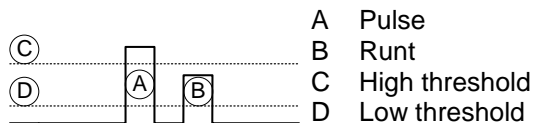

Rise and Fall (Slope) Trigger on rising and or falling edges, below or over a specified rate. The threshold can also be specified.

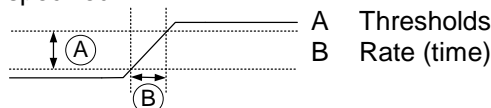

Timeout Triggers when the signal stays high, low or either for a designated amount of time. The trigger level determines when a signal is high or low.

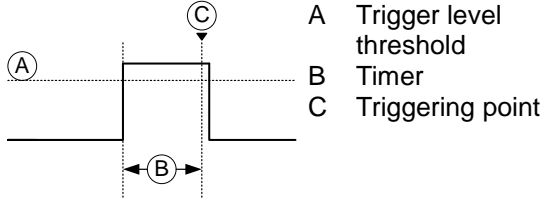

Bus(Optional) Triggers on SPI, UART, I2C, CAN or LIN bus.

3-7-2. Trigger Parameter Overview

All the following parameters are common for all the trigger types unless stated otherwise.

Trigger Source	CH1 ~ 4	Channel 1 ~ 4 input signals
	EXT	External trigger input signal





EXT TRIG





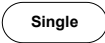



AC Line	AC mains signal
Alternate	Alternate between channel sources for the trigger source.
EXT Probe	Probe trigger source. Set the probe as either current or voltage.

Source Bus	UART	UART bus
	I ² C	Inter-Integrated Circuit
	SPI	Serial Peripheral Bus
	CAN	Controller Area Network bus
	LIN	Local Interconnect Network

Trigger Mode	Auto (un-triggered roll)	The DCS-1000B generates an internal trigger if there is no trigger event, to make sure waveforms are constantly updated regardless of trigger events. Select this mode especially when viewing rolling waveforms at slower timebases.
	Normal	The DCS-1000B acquires a waveform only when a trigger event occurs.

	Single	The DCS-1000B acquires a waveform once when a trigger event occurs, then stops acquiring. Press the Single key to acquire a waveform again.	
Coupling (Edge, Delay, Timeout)	DC	DC coupling.	
	AC	AC coupling. Blocks DC components from the trigger circuits.	
	HF reject	High frequency filter above 70kHz	
	LF reject	Low frequency filter below 70kHz	
Slope (Edge, Delay, Rise & Fall)	Reject noise	DC coupling with low sensitivity to reject noise.	
		Trigger on a rising edge. Trigger on a falling edge. Either. (either rising or falling edge) (Edge, Delay, Rise & Fall trigger type only)	
Trigger Level (Edge, Delay)	Level	Adjusts the trigger manually using the Trigger LEVEL knob.	
			
	Set to TTL 1.4V	Sets the trigger level to 1.4V, suitable for triggering on TTL signals.	
	Set to ECL -1.3V	Sets the trigger to -1.3V. This is suitable for ECL circuits.	
	Set to 50%	Sets the trigger level to 50% of the waveform amplitude.	
Holdoff	Holdoff Set to Minimum	Sets the holdoff time. Set the holdoff time to the minimum.	
Delay (Delay)	Time	Sets the delay time (4ns ~ 10s) between the trigger event and the real trigger timing.	
	Event	Sets the number of events (1 ~ 65535) passed after the trigger event, until the real trigger timing.	
	Set to Minimum	Sets the source trigger to the minimum time.	

When (Pulse Width)	Sets the pulse width (4ns ~ 10s) and the triggering condition.	
	>	Longer than = Equal to
	<	Shorter than ≠ Not equal to
Threshold (Pulse Width)	Sets the amplitude threshold level for the pulse widths.	
	Threshold	-XXV ~ +XXV, user-set level
	Set to TTL	1.4V
	Set to ECL	-1.3V
	Set to 50%	Sets the threshold to 50%
Standard (Video)	NTSC	National Television System Committee
	PAL	Phase Alternate by Line
	SECAM	SEquential Couleur A Memoire
	EDTV	Enhanced Definition Television
	HDTV	high-definition television
Polarity (Pulse Width, Video)		Positive polarity (triggered on the high to low transition)
		Negative polarity (triggered on the low to high transition)
Polarity (Pulse Runt)		Positive polarity (positive runt)
		Negative polarity (negative runt)
		Either (either negative or positive runt)
Trigger On (Video)	Selects the trigger point in the video signal.	
	Odd Field	NTSC: 1 ~ 263 PAL/SECAM: 1 ~ 313 EDTV: 1~525(480P), 1~625(576P) HDTV: 1~750(720P), 1~563(1080i), 1~1125(1080P)
	Even Field	NTSC: 1 ~ 262, PAL/SECAM: 1 ~ 312 HDTV: 1~562(1080i)
	All Fields	Triggers on all fields.
	All Lines	Triggers on all lines.
Trigger On (Bus)	Selects the conditions for the bus triggers.	
	UART Bus	Tx Start Bit, Rx Start Bit, Tx End of Packet, Rx End of Packet, Tx Data, Rx Data, Tx Parity Error, Rx Parity Error
	I ² C	Start, Repeat Start, Stop, Missing Ack, Address, Data, Address/Data
	SPI	SS Active, MOSI, MISO, MOSI&MISO

	CAN	Start of Frame, Type of Frame, Identifier, Data, Id & Data, End of Frame, Missing Ack, Bit Stuffing Err
	LIN	Sync, Identifier, Data, Id & Data, Wakeup Frame, Sleep Frame, Error
Threshold (Pulse Runt)		Sets the upper threshold limit. Sets the lower threshold limit.
Threshold (Rise & Fall)		Sets the High threshold. Sets the Low threshold.
Trigger When (Timeout)	Stays High Stays Low Either	Triggers when the input signal stays high for a designated amount of time. Triggers when the input signal stays low for a designated amount of time. Triggers when the input signal stays high or low for a designated amount of time.
Timer (Timeout)	4nS~10.0S	Sets the amount of time that a signal must stay high or low for the timeout trigger.

3-7-3. Setup Holdoff Level

Background The holdoff function defines the waiting period before the DCS-1000B starts triggering again after a trigger point. The holdoff function ensures a stable display if there are a number of points in a periodic waveform that can be triggered. Holdoff applies to all the triggering types.

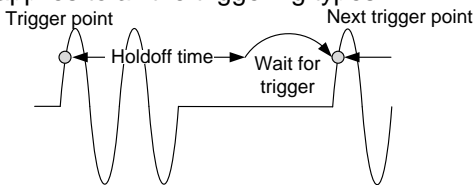

- Panel Operation**
1. Press the trigger *Menu* key.
 2. To set the Holdoff time, press the *Holdoff* (or *Mode/Holdoff*) menu button on the bottom bezel.
 3. Use the side menu to set the Holdoff time.

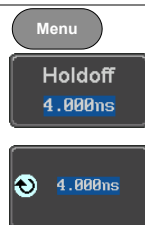

Range 4ns~10s



Note

Pressing *Set to Minimum* sets the Holdoff time to the minimum, 4ns.

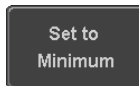

Note: The holdoff function is automatically disabled when the waveform update mode is in roll mode (page65).

3-7-4. Setup Trigger Mode

Background The trigger mode can be set to Normal or Auto (untriggered roll). The triggering mode applies to all the trigger types. See page 65.

- Panel Operation**
1. Press the Trigger menu key.
 2. Press *Mode* from the bottom menu to change the triggering mode.
 3. Use the side panel to select *Auto* or *Normal* triggering modes.
Range Auto, Normal

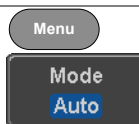

3-7-5. Using the Edge Trigger

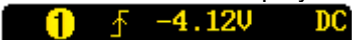
- Panel Operation**
1. Press the trigger *Menu* key.
 2. Press *Type* from the lower bezel menu.
 3. Select *Edge* from the side menu. The edge trigger indicator appears at the bottom of the display.

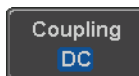
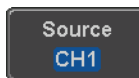
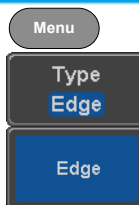
From left: trigger source, slope, trigger level, coupling
 4. Press *Source* to change the trigger source.
 5. Use the side menu to select the trigger source type.
Range Channel 1 ~ 4 (Alternate On/Off), EXT (Ext Probe: Volt/Current, Attenuation: 1mX~1kX, CH2 models only), AC Line
 6. Press *Coupling* from the bottom bezel menu to select the trigger coupling or frequency filter settings.



Choose the coupling from the side menu.

Range DC, AC, HF Reject, LF Reject

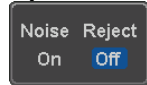
7. Toggle *Noise Rejection* On or Off from the side menu.



Range On, Off

8. From the bottom menu press *Slope* to toggle the slope type.



Range Rising edge, falling edge, either

9. To set the external trigger level, select *Level* from the bottom bezel menu (Not applicable for AC line source).

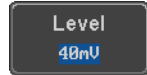

10. Set the external trigger level using the side menu.

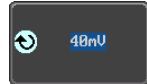

Range 00.0V~ 5 screen divisions

Set to TTL 1.4V

Set to ECL -1.3V

Set to 50%

3-7-6. Using Advanced Delay Trigger

Panel Operation 1. Set the edge trigger source. This will set the initializing trigger for the delay source. Page 95

2. Press the trigger *Menu* key.



3. Press *Type* from the lower bezel menu.



4. Select *Delay* from the side menu. The delay trigger indicator appears at the bottom of the display.

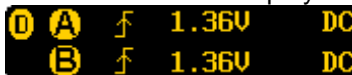

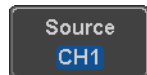

From left: Delay trigger indicator (D), edge trigger (A), edge slope, edge level, edge coupling, delay trigger (B), delay slope, delay trigger level, delay coupling.

5. To set the delay source, press *Source* and select a source from the side menu.

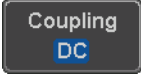

Source CH1 ~ CH4, AC Line, EXT*
 *2 channel models only.

6. Press *Coupling* from the bottom bezel menu to select the trigger coupling or frequency filter settings. 

Choose the coupling from the side menu.
 Range DC, AC, HF Reject, LF Reject
7. To set the delay press *Delay* from the bottom bezel. 
8. To Delay by Time (Duration), press *Time* from the side menu and set the delay time. 

Range 4ns ~ 10s (by time)
 Set to minimum
9. To Delay by Event, press *Event* from the side menu and set the number of events. 

Range 1 ~ 65535 events
 Set to Minimum

3-7-7. Using Pulse Width Trigger

Panel Operation 1. Press the trigger *Menu* key.



2. Press the *Type* key from the lower bezel menu.



3. Select *Pulse Width* from the side menu. The pulse width trigger indicator appears at the bottom of the display.



From left: source, polarity, when, coupling

4. Press *Source* from the lower bezel.



5. Use the side menu to select the pulse width trigger source.

Range Channel 1 ~ 4 (Alternate On/Off),
 EXT (Ext Probe: Volt/Current,
 Attenuation: 1mX~1kX), AC Line

6. Press *Polarity* to toggle the polarity type.

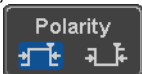

Range Positive (high to low transition)
Negative (low to high transition)

7. Press *When* from the lower bezel.

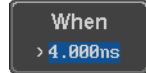

Then use the side menu to select the pulse width condition and width.

Condition > , < , = , ≠

Width 4ns ~ 10s

8. Press *Threshold* from the lower bezel to edit the pulse width threshold.



Use the side menu to set the threshold.

Range -XXV~XXV

Set to TTL 1.4V

Set to ECL -1.3V

Set to 50%

3-7-8. Using Video Trigger

- Panel Operation 1. Press the trigger *Menu* key.



2. Press the *Type* key from the lower bezel menu.



3. Select *Video* from the side menu. The video trigger indicator appears at the bottom of the display.



From left: source, video standard, field, line, coupling

4. Press *Source* from the lower bezel.



5. Use the side menu to select the video trigger source.

Range Channel 1 ~ 4

6. Press *Standard* on the bottom bezel.

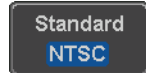

Use the side menu to select the video standard.

Range NTSC, PAL, SECAM, EDTV(480P, 576P), HDTV(720P, 1080i, 1080P)

7. Press *Trigger On* to edit the video field and line.

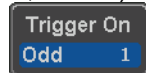

Use the side menu to select the field and line.

Odd Field NTSC: 1 ~ 263
 PAL/SECAM: 1 ~ 313
 EDTV: 1~525(480P), 1~625(576P)
 HDTV: 1~750(720P), 1~563(1080i),
 1~1125(1080P)

Even Field NTSC: 1 ~ 262
 PAL/SECAM: 1 ~ 312
 HDTV: 1~562(1080i)

All Fields Triggers on all fields.

All Lines Triggers on all lines.

8. Press *Polarity* to toggle the polarity type.



Range positive, negative

3-7-9. Pulse Runt trigger

1. Press the trigger *Menu* key.



2. Press the *Type* key from the lower bezel menu.



3. Select *Others* → *Pulse Runt* from the side menu.

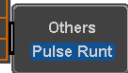

The Pulse and Runt indicator appears at the bottom of the display.

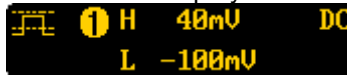

From left: polarity, source, high/low threshold, threshold level, coupling

4. Press *Source* from the lower menu.

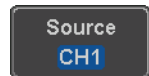

Use the side menu to select a source.

Range Channel 1 ~ 4(Alternate On/Off)

5. Press *Polarity* to toggle the polarity.



Range Rising edge, falling edge, either.

6. Press *When* from the lower menu.

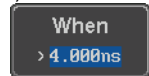

Then use the side menu to select the condition and width.

Condition > , < , = , ≠

- Width 4ns ~ 10s
- Press *Threshold* from the lower bezel to edit the threshold for the upper and lower threshold.
 - Use the side menu to set the upper threshold.
- Range -XXV~XXV
- Use the side menu to set the lower threshold.
- Range -XXV~XXV



3-7-10. Using Rise and Fall Trigger

Panel Operation 1. Press the trigger *Menu* key.



- Press the *Type* key from the lower bezel menu.



- Select *Others* → *Rise and Fall* from the side menu. The Rise and Fall indicator appears at the bottom of the display.

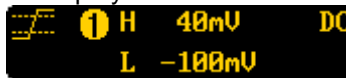
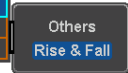

From left: slope, source, high/low threshold, threshold level, coupling

- Press *Source* from the lower menu.



Use the side menu to select a source.

Range Channel 1 ~ 4(Alternate On/Off)

- Press *Slope* from the bottom menu to toggle the slope.



Range Rising edge, falling edge, either

- Press *When* from the lower menu.

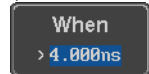

Then use the side menu to select the logic conditions and true or false status.

Condition > , < , = , ≠

Width 4ns ~ 10s

7. Press *Threshold* from the lower bezel to edit the High and Low threshold.
 Range High: -XXV~XXV
 Low: -XXV~XXV



3-7-11. Using the Timeout Trigger

Panel Operation 1. Press the trigger *Menu* key.



2. Press the *Type* key from the lower bezel menu.



3. Select *Others* → *Timeout* from the side menu. The Timeout indicator appears at the bottom of the display.

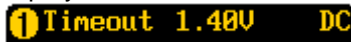
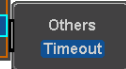

From left: Source, Trigger type, threshold level, coupling

4. Press *Source* from the lower menu.



Use the side menu to select a source.

Range Channel 1 ~ 4, EXT (Ext Probe: Volt/Current, Attenuation: 1mX~1kX), AC Line

5. Press *Coupling* from the bottom bezel menu to select the trigger coupling or frequency filter settings.

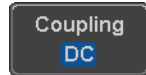

Choose the coupling from the side menu.

Range DC, AC, HF Reject, LF Reject

6. Toggle *Noise Rejection* On or Off from the Coupling side menu.

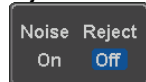

Range On, Off

7. Press *Trigger When* from the lower menu.



Then use the side menu to select trigger conditions.

Condition Stays High, Stays Low, Either

- Press *Level* from the lower bezel to set the trigger level.

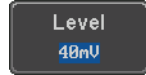

Range -XXV~XXV
 Set to TTL 1.4V
 Set to ECL -1.3V
 Set to 50%

- Press *Timer* from the lower bezel to set the timer time.

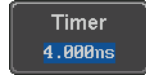

Range 4ns~10.0S

3-7-12. Using the Bus Trigger

The Bus trigger is used to trigger and decode UART, I2C, SPI, CAN and LIN serial bus signals.

3-7-12-1. UART BUS Trigger Settings

The UART bus trigger conditions can be set at any time after the bus settings have been set to *UART*.

- Panel Operation 1. Set the Bus to UART in the bus menu. Page 77

- Press the *Trigger Menu* key.



- Press *Type* from the bottom menu.



- Press *Others* from the side menu and select *Bus*.



The Trigger on settings will be reflected on the Trigger Configuration icon.

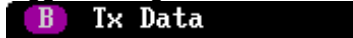

From left: Bus trigger, Trigger source

- Press *Trigger On* and select the triggering condition for the UART bus.



Trigger On Tx Start Bit, Rx Start Bit, Tx End of Packet, Rx End of Packet, Tx Data, Rx Data, Tx Parity Error, Rx Parity Error

Trigger On – Tx Data, Rx Data If Tx Data or Rx Data was configured for the Trigger On setting, then the number of bytes and data can also be configured.

1. Press *Data* from the bottom menu.



2. Press *Number of Bytes* from the side menu and choose the number of bytes for the data.

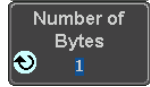

UART 1~10 Bytes

3. Press *Data* from the side menu to edit the triggering data.

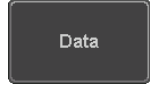

To edit the data, use the *Variable* knob to highlight a binary or hex digit and press *Select*. Use the *Variable* knob to choose a value for the digit and press *Select* to confirm.

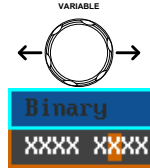

- Binary 0,1,X (don't care)
- Hex 0~F, X (don't care)
- ASCII ASCII characters for the equivalent Hex characters 00 to FF

3-7-12-2. I²C Bus Trigger Settings

The I²C bus trigger conditions can be set at any time after the bus settings has been set to I²C.

Panel Operation 1. Set the Bus to I²C in the bus menu. Page 78

2. Press the *Trigger Menu* key.



3. Press *Type* from the bottom menu.



4. Press *Others* from the side menu and select *Bus*.

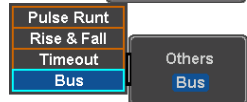

The Trigger on settings will be reflected on the Trigger Configuration icon.



From left: Bus trigger, Trigger source

5. Press *Trigger On* and select the triggering condition for the selected bus.



- Trigger On Start, Repeat Start, Stop, Missing Ack, Address, Data, Address/Data

Trigger On –
Data

If Data or Address/Data was configured for the Trigger On setting, then the number of bytes, data and addressing mode (I²C) can be configured.

1. Press *Data* from the bottom menu.



2. Press *Number of Bytes* from the side menu and choose the number of bytes for the data.

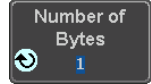

I²C 1~5 Bytes

3. Press *Addressing Mode* to toggle between 7 and 10 bit addressing modes.



4. Press *Data* from the side menu to edit the triggering data.

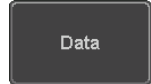

To edit the data, use the *Variable* knob to highlight a binary or hex digit and press *Select*. Use the *Variable* knob to choose a value for the digit and press *Select* to confirm.

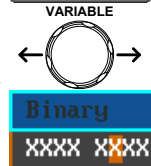

Binary 0,1,X (don't care)

Hex 0~F, X (don't care)

Trigger On -
Address

If Address or Address/Data was configured for the Trigger On setting, then the triggering address must be configured.

1. Press *Address* on the bottom menu.



2. Press *Addressing Mode* to toggle between 7 and 10 bit addressing modes.

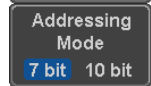

3. To choose a preset address as the default address, press *Choose Preset* and select a preset address.

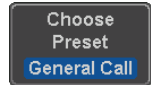

Address	Description
0000 000 0	General Call
0000 000 1	START Byte
0000 1XX X	Hs-mode
1010 XXX X	EEPROM
0000 001 X	CBUS

- Press *Apply Preset* to set the default address to the preset.
- Note
- Presets are not available for *Trigger On Address/Data*.
- Press *Address* from the side menu to manually edit the triggering address.

To edit the address, use the *Variable* knob to highlight a binary or hex digit and press *Select*. Use the *Variable* knob to choose a value for the digit and press *Select* to confirm.

Binary 0,1, X (don't care)
Hex 0~F, X (don't care)
- Direction
- Press *Direction* on the bottom menu and choose the direction from the side menu.

Direction Write, Read, Read or Write

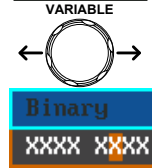
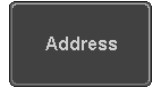
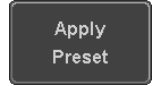

3-7-12-3. SPI Bus Trigger Settings

The SPI bus trigger conditions can be set at any time after the bus setting has been set to SPI.

- Panel Operation
- Set the Bus to SPI in the bus menu. Page 79
 - Press the *Trigger Menu* key.
 - Press *Type* from the bottom menu.
 - Press *Others* from the side menu and select *Bus*.
- The Trigger on settings will be reflected on the Trigger Configuration icon.
- 
- From left: Bus trigger, Trigger source
- Press *Trigger On* and select the triggering condition for the SPI bus.
- SPI SS Active, MOSI, MISO, MOSI&MISO

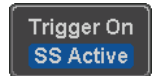
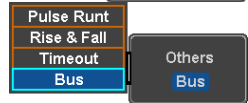
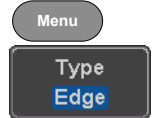

Trigger On –
Data

If MOSI, MISO or MISO/MOSI was configured for the Trigger On setting, then the number of words and the data can be configured.

1. Press *Data* from the bottom menu.

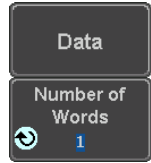

2. Press *Number of Words* from the side menu and choose the number of words for the data.

SPI 1~32 Words

3. Press *MOSI* or *MISO* from the side menu to edit the triggering data. To edit the data, use the *Variable* knob to highlight a binary or hex digit and press *Select*. Use the *Variable* knob to choose a value for the digit and press *Select* to confirm.

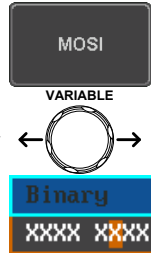

Binary 0,1,X (don't care)

Hex 0~F, X (don't care)

3-7-12-4. CAN Bus Trigger

The CAN bus trigger conditions can be set at any time after the bus setting has been set to CAN.

Panel Operation 1. Set the Bus to CAN in the bus menu. Page 80

2. Press the *Trigger Menu* key.

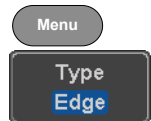

3. Press *Type* from the bottom menu.

4. Select *Others* → *Bus* from the side menu. The Bus indicator appears at the bottom of the display.

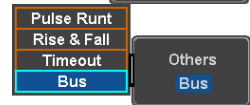



The Trigger on settings will be reflected on the Trigger Configuration icon.

B Id & Data

From left: Bus trigger, Trigger source

5. Press *Trigger On* and select the triggering condition for the selected bus.

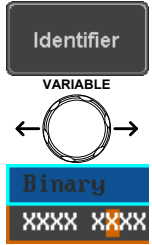

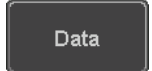
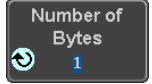
	<p>Trigger On Start of Frame, Type of Frame, Identifier, Data, Id & Data, End of Frame, Missing Ack, Bit Stuffing Err</p>	
Trigger On – Type of Frame	<p>1. If <i>Type of Frame</i> was configured for the Trigger On setting, then the type of frame can be configured from the side menu.</p> <p>Type Data Frame, Remote Frame, Error Frame, Overload Frame</p>	
Trigger On – Identifier	<p>1. If <i>Identifier/Id & Data</i> was configured for the Trigger On setting, select the format from the side menu.</p> <p>Format Standard, Extended</p> <p>2. Press <i>Identifier</i> from the side menu to set the identifier data.</p> <p>To edit the identifier, use the <i>Variable</i> knob to highlight a binary or hex digit and press <i>Select</i>. Use the <i>Variable</i> knob to choose a value for the digit and press <i>Select</i> to confirm.</p> <p>Binary 0,1,X (don't care) Hex 0~F, X (don't care)</p> <p>3. Press <i>Direction</i> on the bottom menu and select the CAN Direction from the side menu.</p> <p>CAN Write, Read, Read or Write Direction</p>	 
Trigger On - Data	<p>If <i>Data/Id and Data</i> was configured for the Trigger On setting, then the triggering data must be configured.</p> <p>1. Press <i>Data</i> on the bottom menu.</p> <p>2. Press <i>Number of Bytes</i> from the side menu and choose the number of bytes for the data.</p> <p>Bytes 1~8 Bytes</p>	 

3. Press *Data* from the side menu to edit the triggering data.
To edit the data, use the *Variable* knob to highlight a binary or hex digit and press *Select*. Use the *Variable* knob to choose a value for the digit and press *Select* to confirm.

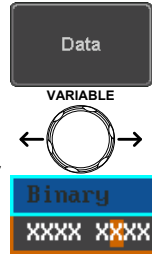

4. Press *Trigger When* from the side menu to choose the triggering condition for the data.

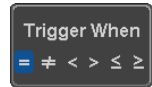

5. The bus will now trigger when the specified data matches the *Trigger When* conditions.

3-7-12-5. LIN Bus Trigger

The LIN bus trigger conditions can be set at any time after the bus setting has been set to LIN.

Panel Operation 1. Set the Bus to LIN in the bus menu. Page 81

2. Press the *Trigger Menu* key.
3. Press *Type* from the bottom menu.

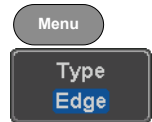

4. Select *Others* → *Bus* from the side menu. The Bus indicator appears at the bottom of the display.

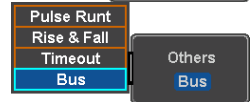

B Sync

5. Press *Trigger On* and select the triggering condition for the selected bus.
Trigger On Sync, Identifier, Data, Id and Data, Wakeup Frame, Sleep Frame, Error.



Trigger On – Identifier 1. If *Identifier* or *Id & Data* was configured for the Trigger On setting, press *Identifier* from the bottom menu.

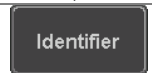

2. Press *Identifier* from the side menu to set the identifier data.
To edit the identifier, use the *Variable* knob to highlight a binary or hex digit and press *Select*. Use the *Variable* knob to choose a value for the digit and press *Select* to confirm.
Binary 0,1,X (don't care)
Hex 0~F, X (don't care)

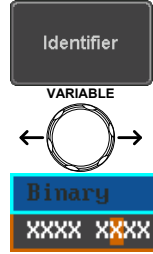

Trigger On - Data

If *Data/Id* and *Data* was configured for the Trigger On setting, then the triggering data must be configured.

1. Press *Data* on the bottom menu.
2. Press *Number of Bytes* from the side menu and choose the number of bytes for the data.
Bytes 1~8 Bytes
3. Press *Data* from the side menu to edit the triggering data.
To edit the data, use the *Variable* knob to highlight a binary or hex digit and press *Select*. Use the *Variable* knob to choose a value for the digit and press *Select* to confirm.
Binary 0,1,X (don't care)
Hex 0~F, X (don't care)
4. Press *Trigger When* from the side menu to choose the triggering condition for the data.
When =, ≠, <, >, ≤, ≥
5. The bus will now trigger when the specified data matches the *Trigger When* conditions.

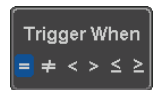
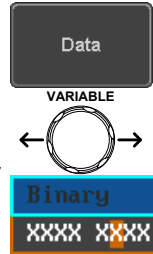
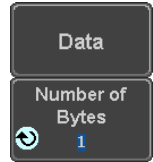

3-7-13. Bus Trigger Mode

1. Like the other trigger configurations, the Bus Trigger mode can be set to Auto (Untriggered Roll) and Normal.

2. Press *Mode* from the bottom menu to change the triggering mode.
3. Use the side panel to select *Auto* or *Normal* triggering modes.



3-8. Search (Option)

The search feature can be used to search for events on the analog input channels. The events that can be searched for are similar to the events that are used for the trigger system. The only difference is that the search feature uses the measurement threshold levels rather than the trigger level to determine events.

3-8-1. Configuring Search Events

Background Similar to configuring the trigger system, the Search events must first be configured before they can be found. Luckily the trigger system configuration settings can also be used for the search events. The types of searches are listed below. Please note that a full description of the events can be found in the Trigger section on page 89.

Display

Number of search events Trigger point

Search Event Types Edge, Pulse Width, Pulse Runt, Rise and Fall Times, FFT Peak*, Bus
 *The FFT Peak search event doesn't have a trigger equivalent.

Panel Operation 1. Press the *Search* menu key.



2. Press *Search* from the bottom menu and turn the Search function on.
3. Press *Search Type* from the bottom menu and select the type of search. The search events are configured in the same fashion as the trigger events.



Please see the trigger configuration settings for details:

Event Edge, Pulse Width, Pulse Runt,
Types: Rise/Fall Time, FFT Peak*, Bus
 *No trigger equivalent.

4. To set the threshold levels for the search events (instead of the trigger level that is used for trigger events), use the threshold soft-key from the bottom menu.

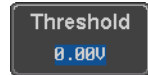

Note

The search function can support up to 10,000 events, however only 1,000 events can be displayed on screen at once.

3-8-2. Copying Search Event To/From Trigger Events

Background As the trigger system and search feature have similar settings, their settings can be used interchangeably by using the Copy functions.

Interchangeable Settings Edge, Pulse Width, Pulse Runt, Rise and Fall Times, Bus (FFT Peak has no trigger equivalent)

- Panel Operation**
1. Press *Search* from the lower bezel menu.
 2. To copy the settings of the selected search type to the trigger settings, select *Copy Search Settings to Trigger*.
 3. To copy over the current trigger settings to the search settings, press *Copy Trigger Settings To Search*.

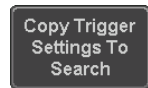

Note

If the settings cannot be copied or if there are no trigger settings configured (so that you cannot copy from the trigger settings), then those particular options will not be available.

3-8-3. Search Event Navigation

Background When using the search feature, each event can be searched for according to the event settings.

- Operation**
1. Turn Search on and set the appropriate search type. Page110
 2. Search events are marked by hollow white triangles at the top of the graticule.
 3. Use the search arrow keys to move between each search event.
Search events can be navigated in both stop and run mode.

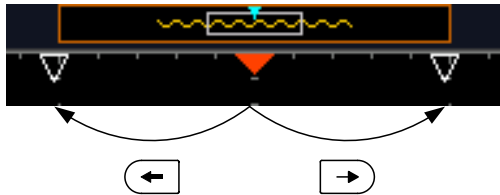

When using the arrow keys to navigate to each event, the “current event” will always be centered on the display.

3-8-4. Save Search Marks

Background The search events can be saved to the graticule display, allowing you to superimpose new search events. Search events are saved over the entire record length, with a maximum of 1000 marks.

- Save Marks**
1. Press *Search* from the lower bezel menu.
 2. Press the *Save All Marks* soft-key.
 3. The search event markers will become solid white triangles to indicate that they have been saved.



Clear All Marks To clear all the saved marks, press *Clear All Marks* from the side menu.



Note

Each time the *Save All Marks* function is used, the previously saved marks will also be retained, unless cleared.

3-8-5. Setting/Clearing Single Search Events

Background In addition to searching for search events based on Search Type settings, custom search marks can be created with the Set/Clear key.

Set Search Event 4. Navigate to a point of interest using the horizontal position knob or some other method.

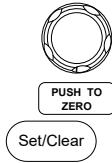

1. Press the *Set/Clear* key.
2. A marker will be saved at the center of the display.
 - This marker can be navigated to/from in the same way that a normally saved search marker can.

Clear Search Event To clear a set search event, use the search arrows to navigate to the event of interest and press the *Set/Clear* key. The marker will be deleted from the display.

3-8-6. FFT Peak

Background The FFT Peak search type can be used to mark all FFT peaks that are above a certain threshold.

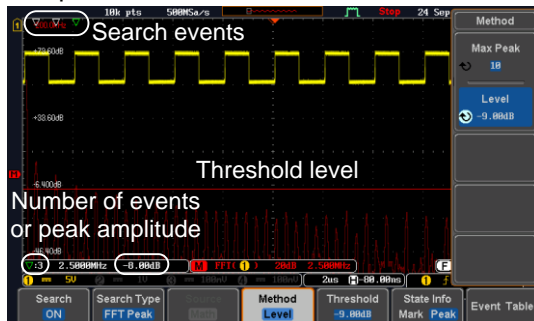

The search function can support up to 10,000 events, however only 1,000 events can be displayed on screen at once.

Panel Operation 1. Turn the FFT math function on. Page 41

2. Press the *Search* menu key.
3. Press *Search* from the bottom menu and turn the Search function on.
4. Press *Search Type* from the bottom menu and select *FFT Peak* from the side menu.
5. Note that the Math source is automatically selected.
6. Next, select the event search method by pressing *Method* from the bottom menu. Select *Max Peak* to search by a selected number of “max” peaks. Select *Level* to set the threshold level for the search events. Any peaks above the threshold level will be seen as a search event. The threshold level will be mirrored in the Threshold key.

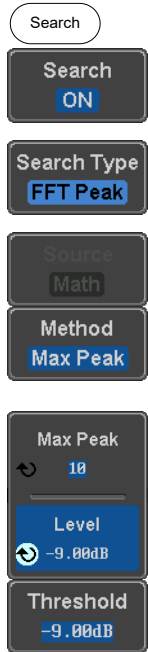

Max Peak 1 ~ 10
 Level -100db ~ 100dB

View Number of Peak Events

To view the number of peak events, set *State Info* to Mark. The number of search events will be shown at the bottom of the screen.



View Amplitude of Peak Search Event

To view the position and amplitude of a selected event, set *State Info* to Peak. This information will be shown at the bottom of the display.



Peak Event Table

The Event Table function tabulates the amplitude and frequency of each peak event in real time. The event table can also be saved to a USB disk drive. File names are saved as a PeakEventTbXXXX.csv, where XXXX is a number starting from 0001 and is incremented each time the event table is saved.

1. Press *Event Table* from the bottom menu and turn the Event Table function on.



The event table will appear on the screen.

No.	Frequency	Value
1	1.0000MHz	-30.4dB
2	2.0000MHz	-31.2dB
3	3.0000MHz	-32.0dB
4	4.0000MHz	-35.2dB
5	5.0000MHz	-38.4dB
6	6.0000MHz	-44.0dB
7	7.0000MHz	-54.4dB
8	9.0000MHz	-52.0dB
9	10.000MHz	-51.2dB
10	11.000MHz	-52.0dB
11	12.000MHz	-58.4dB
12	497.000MHz	-58.4dB
13	498.000MHz	-56.0dB
14	499.000MHz	-54.4dB

Amplitude

Peak frequency

Peak number

Save Event Table

1. To save the event table, insert a USB memory drive into the front panel USB-A port.
2. Press *Save Event Table*. The event table will be saved as PeakEventTbXXXX.csv.

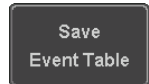
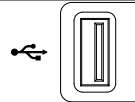

Event Table CSV Format

The format for the CSV file is the same as the event table displayed on the DCS-1000B screen; No., Frequency, and Value.

For example:

No.	Frequency	Value
1	1.0000MHz	-29.6dB
2	2.0000MHz	-30.4dB
3	3.0000MHz	-32.0dB

Center Peak Results on Screen

To shift the peak events to the center of the screen, press *Selected Peak To Center* from the event table side menu.

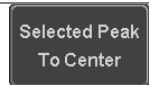

3-9. System Settings and Miscellaneous Settings

This section describes how to set the interface, language, probe compensation signal, erase the internal memory.

3-9-1. Select Menu Language

Description The DCS-1000B has a number of different languages to choose from.

- Panel Operation**
1. Press the *Utility* key.
 2. Press *Language* on the lower menu.
 3. Select the language* from the side menu.
*Language selection may differ based on region, and as such are not listed here.



3-9-2. View System Information

- Panel Operation**
1. Press the *Utility* key.
 2. Press *System* from the lower menu.
 3. Press *System Info* from the side menu. A display panel will appear showing:

- Manufacturer name
- Model name
- Serial number
- Firmware version
- Manufacturer URL

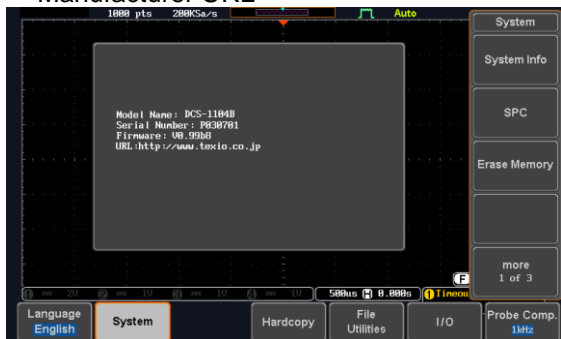
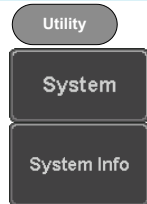

3-9-3. Erase Memory

Background	The Erase Memory function will erase all internal waveforms, setup files and labels from internal memory.
Erased Items	Waveform 1~20, Setting memory 1~20, Reference 1~4, Labels
Panel Operation	<ol style="list-style-type: none"> 1. Press the <i>Utility</i> key. 2. Press <i>System</i> from the lower menu. 3. Press <i>Erase Memory</i> from the side menu. <p>A message will prompt you to press Erase Memory again to confirm the process. Pressing any other key will cancel erasing the memory.</p> <ol style="list-style-type: none"> 4. Press <i>Erase Memory</i> again.



3-9-4. Probe Compensation Frequency

Background	The probe compensation output can be set from 1kHz (default) to 200kHz, in steps of 1kHz.	
Panel Operation/ Parameter	<ol style="list-style-type: none"> 1. Press the <i>Utility</i> key. 2. Press <i>Probe Comp.</i> on the lower menu. 3. Press <i>Frequency</i> and change the frequency of the probe compensation signal. 	
Default Frequency	<ol style="list-style-type: none"> 4. Press Default to set the frequency of the probe compensation signal to 1kHz default. 	

4. Applications

4-1. Overview

Background	The APP function allows different software applications to be run. The DCS-1000B comes pre-installed with a number of apps.	
Included Applications	Go/No-Go	The Go/No-Go application can be used to set threshold boundaries for input signals. Go/No-Go tests to see if a waveform will fit inside a user-specified maximum and minimum amplitude boundary (template).
	Mount Remote Disk	This app allows the scope to mount a network share drive.
Optional Apps	DVM	The DVM application displays a digital voltage meter readout that floats on the top left-hand side of the screen.
	Data Log	The Data Log app will log waveform data and/or screenshots at set intervals for set duration of time.
	Digital Filter	Adds a digital low or high filter to any of the input channels. Each filter can have a user-defined cutoff frequency set.

Optional app must be installed, Please See Page 152.

4-2. Running Applications

Background The APP function can host a number of different applications that can be downloaded from the GW Instek website.

- Panel Operation**
1. Press the *APP* key.
 2. Press *APP* from the bottom menu.
 3. Scroll through each application using the *Variable* knob.



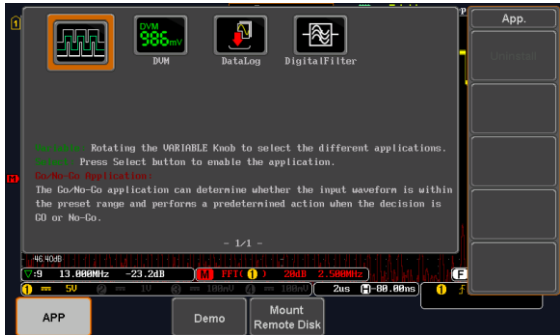

4. Select an application by pressing the **Select** key **x2**.

4-3. Using Go-NoGo

Background

The Go-NoGo test checks if a waveform fits inside a user-specified maximum and minimum boundary. Boundary templates are automatically created from a source channel. Boundary tolerances and violation conditions can be set.

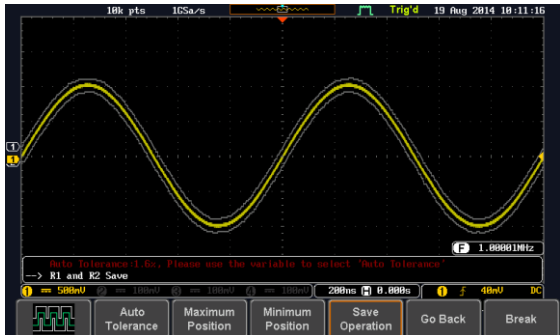

Choose the **Go_NoGo** application from the APP menu. See page 118.

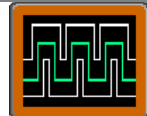







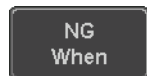

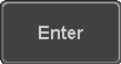
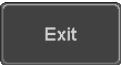
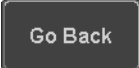
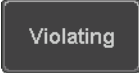

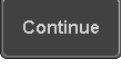
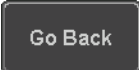
Set Go-NoGo Conditions

Select the Go-NoGo conditions (**NG When**) and actions when a Go-NoGo condition has been met (**Violating**).

1. Press **NG When** from the bottom menu and select the **NoGo** conditions:

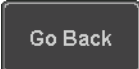

	<p> Enter: Sets the NoGo condition to when the input signal stays within the limit boundary.</p> <p> Exit: Sets the NoGo condition to when the input signal exceeds the limit boundary.</p>	
	2. Press <i>Go Back</i> to return to the previous menu.	
Set Go-NoGo Actions	3. Press <i>Violating</i> to set what action to perform when a signal violates the Go-NoGo conditions.	
	<p> The waveform stops when the conditions are violated.</p> <p> Ignore violations and continue to monitor the signal. Each violation is counted.</p>	
	4. Press <i>Go Back</i> to return to the previous menu.	
Set Go-NoGo Source	5. Press <i>Compare Source</i> from the bottom menu to set the Go-NoGo boundary source.	
	 Sets CH1 as the source.	
	 Sets CH2 as the source.	
	 Sets CH3 as the source.	
	 Sets CH4 as the source.	
	6. Press <i>Go Back</i> to return to the previous menu.	
Set Boundary Tolerance	7. To set the Go-NoGo boundary tolerance, press <i>Reference Mode</i> .	

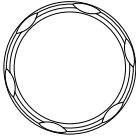
Auto Tolerance	8. To set the boundary tolerance as a percentage offset from the source waveform, press <i>Auto Tolerance</i> and use the Variable knob.	<div style="border: 1px solid black; padding: 5px; text-align: center; width: fit-content; margin-bottom: 10px;">Auto Tolerance</div> <div style="text-align: center; font-weight: bold; font-size: small; margin-bottom: 10px;">VARIABLE</div> 
Maximum and Minimum Position	<p style="text-align: center;">Offset 0.4% ~ 40% (.4% steps)</p> 9. To manually set the template tolerance, press <i>Minimum Position</i> or <i>Maximum Position</i> and use the Variable knob to set the absolute minimum or maximum position.	<div style="border: 1px solid black; padding: 5px; text-align: center; width: fit-content; margin-bottom: 10px;">Minimum Position</div> <div style="text-align: center; font-weight: bold; font-size: small; margin-bottom: 10px;">or</div> <div style="border: 1px solid black; padding: 5px; text-align: center; width: fit-content; margin-bottom: 10px;">Maximum Position</div>
Save Boundary Template	<p style="text-align: center;">Range Voltage division range</p> 10. Press <i>Save Operation</i> to save the tolerance boundaries. 11. The Maximum Position tolerance will be saved to reference waveform R1, and the Minimum Position tolerance to R2. 12. Press <i>Go Back</i> to return to the previous menu.	<div style="border: 1px solid black; padding: 5px; text-align: center; width: fit-content; margin-bottom: 10px;">Save Operation</div> <div style="border: 1px solid black; padding: 5px; text-align: center; width: fit-content; margin-top: 10px;">Go Back</div>

Start Go-NoGo Press *Enable* to start the Go-NoGo test. The Enable button will change to Disable. Pressing *Disable* will stop the Go-NoGo test and toggle the button back to Enable. If the Violating setting was set to Stop, press *Enable* to restart the test after it has stopped.

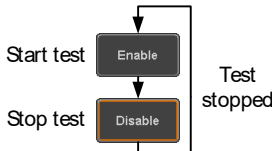

Results When Go-NoGo is running, the violation/test ratio is displayed in the bottom left-hand corner. The first digit represents the number of violations, and the right hand digit represents the number of tests.

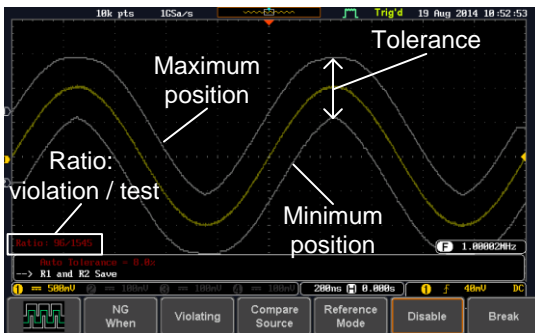

Exit the Application

To exit the application, press *Break*.

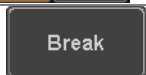

Note

After you exit the Go/NoGo app, the boundary templates that were saved to R1 & R2 reference waveforms will still be turned on. See page 146 to turn the reference waveforms off.

Using the Go-NoGo Output

To output the Go-NoGo results to an external device, the Go-NoGo rear panel terminal (open collector) can be used. The Go-NoGo terminal will output a positive pulse each time a NoGo violation has occurred for a minimum of 500us. The voltage of the pulse depends on the external pull-up voltage.

GO / NO GO



OPEN COLLECTOR

Timing Diagram

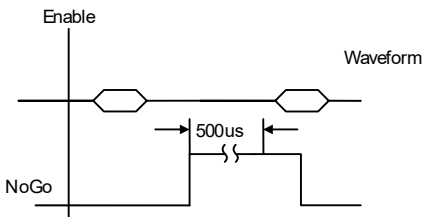

Circuit Diagram

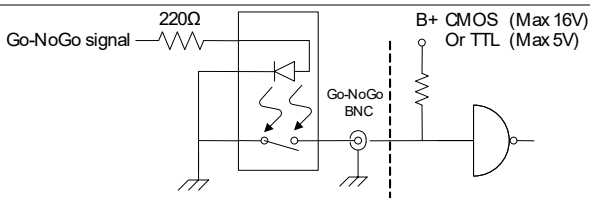

4-4. Using the DVM (Option)

Background

The DVM app is a digital voltage meter or digital current meter readout that floats on the top left-hand side of the screen. However, please note that if the cursors (refer to page 34) are turned on, the DVM readout will be replaced by the cursor readout.

The DVM app allows you to measure the AC RMS, DC, DC RMS, Duty and frequency of an input signal. This software is especially useful for those measurement applications that require both a DSO and a basic DVM to be used at the same time.

Basic Features:

- 3 digit resolution for voltage measurements
- 5 digit resolution for frequency
- Input channel selection

Example

DVM function indicator

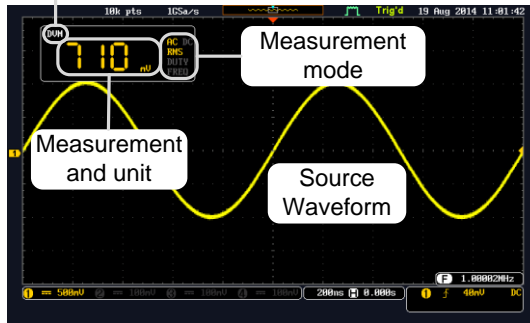

Panel Operation Choose the DVM application from the APP menu. See page 118.



Set Source

1. Press *Source* and select the source channel for the DVM. The probe type setting (voltage or current) determines whether the function acts as a digital volt meter or as a digital current meter for the selected source. See page 72 to set the probe type.



Source CH1 ~ CH4

Mode

The Mode setting determines the measurement mode for the meter.

2. Press *Mode* and select the mode.



Mode AC RMS, DC, DC RMS, Duty, Frequency

Turn On/Off

3. Press *DVM* and toggle DVM on. The DVM app will remain running in the background even if other functions are turned on.



4-5. Using the Data Logger (Option)

Background

The Data Log app will log the current waveform data or screenshot at set intervals for a set duration of time.

Basic Features:

- Log up to 100 hours of images or waveform data.
- Interval times of up to 2 seconds (waveform) or 5 seconds (images).

Example

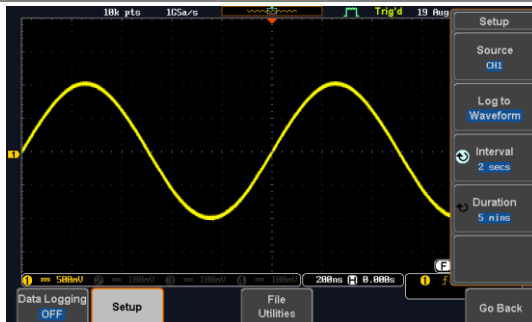

Panel Operation Choose the Data Log application from the APP menu. See page 118.



1. Press *Setup*.



2. Press *Log to* from the side menu and select what type of data to log, waveform data or screenshots.



Log to Image, Waveform

3. Press *Source* from the side menu and select a source channel to log if waveforms are to be logged.



Source CH1 ~ CH4, All Displayed

4. Press *Interval* and set the logging interval time.

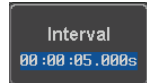

Interval Data: 2secs ~

Image: 5secs ~

5. Press *Duration* and select the logging duration time.

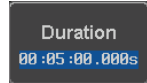

Duration 5mins ~ 100hrs.

6. Press *Interval* and set the logging interval time.

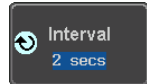

Interval Data: 2secs ~ 2mins

Image: 5secs ~ 2mins

7. Press *Duration* and select the logging duration time.



Duration 5mins ~ 100hrs.

8. From the bottom menu, press *File Utilities* and set the save file path. See the File Utilities chapter r details.

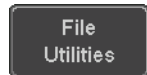

Page 148

Turn On/Off	<p>9. Press <i>Data Logging</i> from the bottom menu and toggle Data Logging on.</p> <p>The data/images will be saved to the designated file path when Data Logging is turned on.</p> <p>The Data Logging app will remain running in the background even if other functions are turned on.</p>	
Set File Path	<p>10. Press <i>File Utilities</i> to set the file path.</p>	Page 148
NOTE:	<p>The DCS-1000B does not have a built-in clock, so the date and time are not recorded.</p>	

4-6. Using the Digital Filter (Option)

Background

The Digital Filter app is a digital high or low pass filter with a selectable cutoff frequency. The digital filter can be applied to each channel individually or together using the tracking functionality.

Basic Features:

- High pass or low pass filtering of analog channels.
- Selectable cutoff frequencies.
- Tracking function

Example

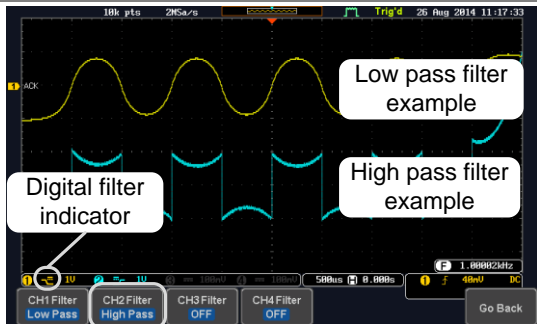

Digital filter
type or status

CH1 input: 2Vpp 1kHz square wave, low pass filter with 1kHz cutoff frequency.

CH2 input: 2Vpp 1kHz square wave, high pass filter with 1kHz cutoff frequency.

Panel Operation

Choose the Digital filter application from the APP menu. See page 118.



Set Source

1. Select a source channel by pressing *CH1Filter*, *CH2 Filter*, *CH3 Filter* or *CH4 Filter*.
2. From the side menu press *Filtering* and turn on.
3. Press *Filter Type* and select low or high pass filter.



Type Low Pass, High Pass

- If Low Pass was selected, press *Upper Limit* to set the low pass cutoff frequency. Likewise if High Pass was selected, press *Lower Limit* to set the high pass cutoff frequency. Only one option will be available at a time.

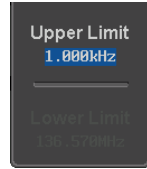

Upper Limit 1Hz ~ 500MHz
Lower Limit 1Hz ~ 500MHz

Tracking

- Press *Tracking* if you want the settings of the digital filter on each channel to be the same. When a setting is changed on one channel, it is reflected on the other channels.

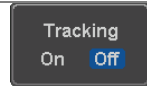

Note

The digital filter settings will still apply to the relevant input signals after leaving the app, unless turned off.

4-7. Remote Disk

Background

The Remote Disk app allows the scope to mount a network share drive.

Basic Features:

- Save and load files from the network share drive.
- Ability to automatically mount the network share drive at startup.

Example

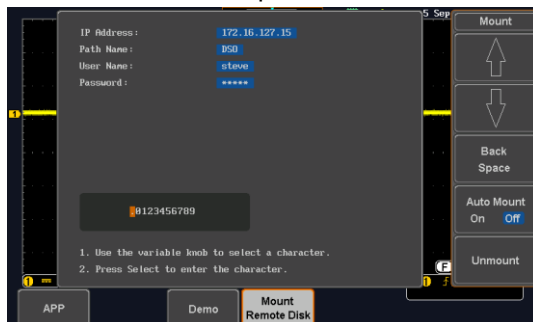

Panel Operation 1. Press the *APP* key.



- Press *Mount Remote Disk* from the bottom menu.

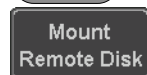

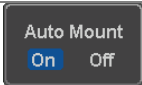
	<p>3. A form will appear (above) prompting you to enter the IP Address, Path Name, User Name and Password.</p> <ul style="list-style-type: none"> • IP Address refers to the IP address of the network share drive. • Path Name refers to name of the shared directory of the network drive. This path must be in the root directory of the boot drive of the network disk. No sub-directories are allowed in the path name. For example a path name of “DSO” would be equivalent to C:/DSO. • User Name refers to a username with permission to access the share drive. • Password refers to the password for the username above. • Use the Up and Down soft-keys navigate to each item in the form. • Use the Variable knob and Back Space soft-key to enter characters for each item in the form. 	
Mount/Unmount	<p>4. To mount the network share driver, press <i>Mount</i> from the side menu. Press again to unmount. When the drive is successfully mounted, “Complete!” will be shown on the display.</p>	
Auto Mount	<p>5. Press <i>Auto Mount</i> to automatically mount the network share drive at startup.</p>	
Set File Path	<p>6. When accessing the file utilities, the network share drive is shown as “Z” drive. Files can be saved to or recalled from the network share drive in the same manner as the internal memory or a USB flash disk. See the File Utilities chapter for usage details.</p>	Page 148

Example

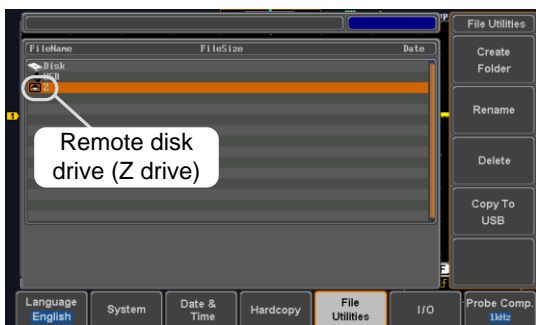

5. SAVE/RECALL

5-1. File Format/Utility

5-1-1. Image File Format

Format	*.bmp or *.png
Default	DSxxxx.bmp/png
Filename	
Contents	The display image is 800 by 480 pixels. The background color can be inverted (Ink saver function). Each image file is saved to the current file path as a bitmap or PNG file.

5-1-2. Waveform File Format

Format	DSxxxx.lsf, CH1~CH4.lsf The LSF file format efficiently stores waveforms. This is the file format used for storing and recalling all waveforms that are used with the DCS-1000B series.	
Filename	DSxxxx.lsf, CH1 ~ CH4.lsf	
Waveform Type	CH1 ~ 4	Input channel signal
	REF	Reference waveform
	Math	Math operation result (page 39)
Storage Location	Wave1 ~ Wave20	Waveform files stored to the internal memory. Stored waveforms can be transferred to Ref. 1 ~ 4 to be viewed on the display. (W1 ~ W20 waveforms cannot be directly recalled on the display).
	Ref 1~4	Reference waveforms stored in the internal memory, separate from W1 ~ W20. Reference waveforms (Ref 1 ~ 4) can be displayed directly onto the display with amplitude and frequency information. Ref 1~4 are useful for reference purposes. Other waveforms (LSF and W1~20) must be recalled to R1~4 before being displayed.
Contents: Waveform Data	The waveform data can be used for detailed analysis. It consists of the horizontal and vertical data used by the waveform.	

5-1-3. Spreadsheet File Format

Format *.csv (Comma-separated values format, can be opened in spreadsheet applications such as Microsoft Excel).

CSV-formatted files can be stored in either a short-memory format or a long-memory format: Detail CSV, Fast CSV. The number of points that are saved depends on the record length settings.

Detail CSV will record both the horizontal and vertical sample points of the waveform. All the points are recorded in scientific notation for analog data.

Fast CSV will only record the vertical amplitude of the sample points. Fast CSV also contains data that enables the horizontal data points to be reconstructed, such as trigger position, etc. Data is recorded as integers.

Note, however, that only fast CSV can be recalled to the internal memory. Detailed CSV cannot be recalled.

Filename	DSxxxx.csv
Waveform Type	CH1 ~ 4 Input channel signal Ref1~4 Reference waveform Math Math operation result (page 39) All All the waveforms on the display. Displayed
Contents: Detail CSV	Detail CSV waveform data contains channel information such as vertical and horizontal position of a signal for all the recorded points. The following information is included in Detail CSV, where applicable: <ul style="list-style-type: none">• Format (scope type)• Trigger Level• Label• Vertical units• Vertical position• Horizontal scale• Memory length• Source• Probe ratio• Vertical scale• Horizontal units• Horizontal position

- Horizontal mode
- Firmware
- Vertical data
- Sampling period
- Mode
- Horizontal data

Contents: Fast CSV	<p>The following information is included in the Fast CSV waveform files, where applicable:</p> <ul style="list-style-type: none"> • Format (scope type) • IntpDistance (input trigger distance) • Trigger level • Vertical units • Vertical units extend div • Probe type • Vertical scale • Horizontal units • Horizontal position • SincET mode (sampling mode) • Horizontal old scale • Firmware • Raw vertical waveform data • Memory length • Trigger address • Source • Vertical units div • Label • Probe ratio • Vertical position • Horizontal scale • Horizontal mode • Sampling period • Horizontal old position • Mode
-----------------------	---

5-1-4. Setup File Format

Format	DSxxxx.set (proprietary format)	
	The setup file saves or recalls the following settings.	
Contents	Acquire	<ul style="list-style-type: none"> • Mode • Sample rate • XY
	Display	<ul style="list-style-type: none"> • Sample mode • Record Length • Mode • Backlight intensity • Persistence • Graticule intensity • Waveform intensity • Backlight • Graticule intensity • Auto-dim

Channel	<ul style="list-style-type: none"> • Scale • Channel • Coupling • Impedance • Invert • Bandwidth 	<ul style="list-style-type: none"> • Expand • Position • Probe • Probe attenuation • Deskew
Cursor	<ul style="list-style-type: none"> • Horizontal cursor • H Unit 	<ul style="list-style-type: none"> • Vertical cursor • V Unit
Measure	<ul style="list-style-type: none"> • Source • Gating • Statistics 	<ul style="list-style-type: none"> • Display • High-Low • Reference levels
Horizontal	<ul style="list-style-type: none"> • Scale 	
Math	<ul style="list-style-type: none"> • Source1 • Operator • Source2 	<ul style="list-style-type: none"> • Position • Unit/Div • Math Off
FFT Math	<ul style="list-style-type: none"> • Source • Vertical Units • Window 	<ul style="list-style-type: none"> • Vertical position • Horizontal position
Advanced Math	<ul style="list-style-type: none"> • Expression • VAR1 • VAR2 	<ul style="list-style-type: none"> • Position • Unit/Div
Trigger	<ul style="list-style-type: none"> • Type • Source • Coupling • Alternate • Rejection • Noise Rejection 	<ul style="list-style-type: none"> • Slope • Level • Mode • Trigger When • Timer • Holdoff
Utility	<ul style="list-style-type: none"> • Language • Hardcopy key • File Format 	<ul style="list-style-type: none"> • Ink Saver • Assign Save • Probe Comp.
Save/recall	<ul style="list-style-type: none"> • Image file format 	<ul style="list-style-type: none"> • Data file format

5-2. Create/Edit Labels

Overview

Reference files, Setup files and the analog input channels can have individual file labels set. For the analog channels and reference waveforms, the file label can be displayed next to the channel/reference indicator. The file labels are also used to easily identify reference files, setup files or channels when saving or recalling waveforms and setups.

Example

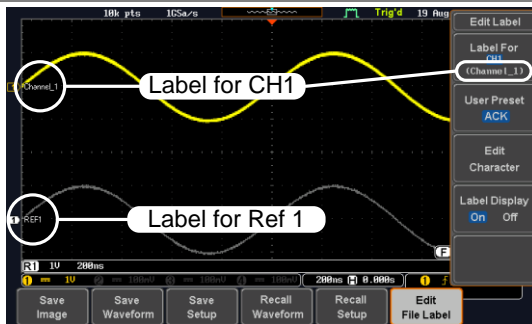

In the example above, the file label for channel 1 is displayed next to the channel indicator and is also displayed in the *Edit Label* menu. The Ref_1 file label is shown next to the reference indicator.

Panel Operation

1. Press the *Save/Recall* key from the front panel.
2. Press *Edit File Label* from the bottom menu.
3. Press *Label For* and select the item that you want to create the label for.
Label For CH1~CH4, Ref1~4, Set1~20, Math
4. To choose a preset label, Press *User Preset* from the side menu and choose a label.



Labels ACK, AD0, ANALOG, BIT, CAS, CLK, CLOCK, CLR, COUNT, DATA, DTACK, ENABLE, HALT, INT, IN, IRQ, LATCH, LOAD, NMI

Edit Label

1. Press *Edit Character* to edit the current label.
2. The Edit Label window appears.

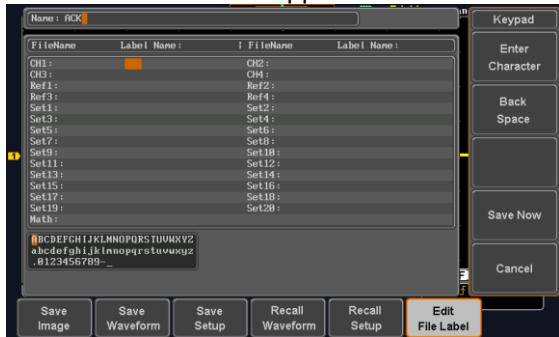

3. Use the Variable knob to highlight a character.



Press *Enter Character* to select a number or letter.

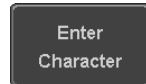

Press *Back Space* to delete a character.

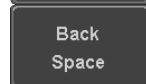

Press *Save Now* to save the label and return to the previous menu.

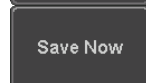

To cancel the editing the label and return to the previous menu, press *Cancel*.

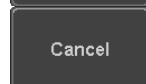

Display Label

To display the currently selected file label on the screen next to its respective indicator, toggle *Label Display* to On.

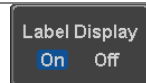

Conversely, if you want to remove the currently selected file label from the display, toggle *Label Display* to Off.

5-3. Save

5-3-1. File Type/Source/Destination

Item	Source	Destination
Panel Setup (DSxxxx.set)	<ul style="list-style-type: none"> • Front panel settings 	<ul style="list-style-type: none"> • Internal memory: Set1 ~ 20 • File system: Disk, USB
Waveform Data (DSxxxx.csv) (DSxxxx.lsf) (CH1~CH4.lsf, Ref1~Ref4.lsf, Math.lsf)* ALLxxxx.csv	<ul style="list-style-type: none"> • Channel 1 ~ 4 • Math operation result • Reference waveform Ref1~4 • All displayed waveforms 	<ul style="list-style-type: none"> • Internal memory: Reference waveform Ref1~4, Wave1 ~ 20 • File system: Disk, USB
Display Image (DSxxxx.bmp/png) (Axxx1.bmp/png)**	<ul style="list-style-type: none"> • Display image 	<ul style="list-style-type: none"> • File system: Disk, USB

*Stored in ALLXXXX directories when All Displayed waveforms are saved.

**Stored in ALLXXXX directories when the Hardcopy key is assigned to save Waveform, Setup or All.

Note: By default all filenames/directories are named DSxxxx/ALLxxxx where xxxx is a number starting from 0001 and is incremented by one after each save.

The DCS-1000B does not have a built-in clock, so the date and time are not recorded.

5-3-2. Save Image

Images can be saved either using the Save/Recall key or by using the Hardcopy key. To save images using the Hardcopy key, see the hardcopy section on page153.

Panel Operation 1. To save to USB, connect a USB Front Panel drive to the front panel USB port. If a USB drive is not connected, images can still be saved to the internal memory.

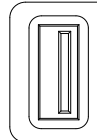

2. Press the *Save/Recall* key from the front panel.
3. Press *Save Image* from the bottom menu.



- Press *File Format* to choose PNG or BMP file types.

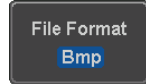

Range DSxxxx.bmp, DSxxxx.png

- Press *Ink Saver* to toggle Ink Saver On or Off.

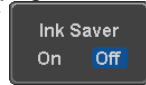

Ink Saver On

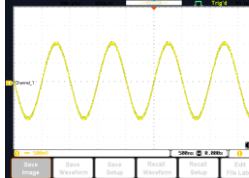

Ink Saver Off

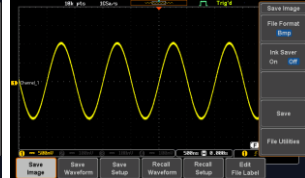

- Press *Save* from the side menu to save the display as an image file.

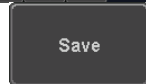

- You will automatically be taken to a file utility where you will be able to edit the name of the file.
- To edit the file name, use the *Variable* knob to highlight a character.



Press *Enter Character* or the *Select* key to select a number or letter.

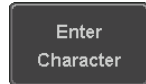

Press *Back Space* to delete a character.

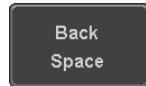

- Press *Save Now* to save the file. The file name need not have been edited to save the file.

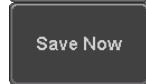

Note: Pressing *Cancel* will cancel the save operation and return you to the *Save/Recall* menu.

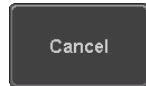

After *Save Now* has been pressed the file will be saved.





Note

The file will not be saved if the power is turned off or the USB drive is taken out before the message ends.

File Utility

To edit the internal memory or the USB flash drive contents (create/delete/rename files and folders) or to edit the default file path, press *File Utilities* from the side menu. See page 148 for details.



5-3-3. Save Waveform

Panel Operation

1. To save to an external USB flash drive, connect the drive to the front panel USB port. If a USB drive is not connected, files can still be saved to the internal memory.

Front Panel

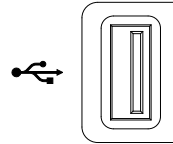

- 2. Press the *Save/Recall* key from the front panel.
- 3. Press *Save Waveform* from the bottom menu.
- 4. Choose the *From* waveform on the side menu.

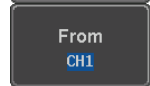

Source CH1~4, Math, Ref1~4, All Displayed

5. Press *To* (internal memory) or *To File* and choose a destination to save.



To Ref1~4, Wave1~20
To File Format: LSF, Detail CSV, Fast CSV

6. Press *Save* to save the file.

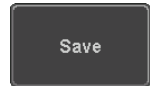

7. If you are saving to a file, a file utility appears where you will be able to edit the name of the file from the default "DSXXX" filename.

- To edit the filename, use the *Variable* knob to highlight a character.



Press *Enter Character* or the *Select* key to select a number or letter.

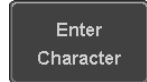

Press *Back Space* to delete a character.



- Press *Save Now* to save the file. The filename need not have been edited to save the file.

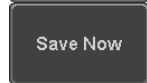

Note: Pressing *Cancel* will cancel the save operation and return you to the *Save/Recall* menu.

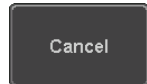

After *Save Now* has been pressed the file will be saved.



Note

The file will not be saved if the power is turned off or the USB drive is taken out before the message ends.

File Utility	To edit the internal memory or the USB flash drive contents (create/delete/rename files and folders), press <i>File Utilities</i> . For details, see page148.	
--------------	---	--

5-3-4. Save Setup

- Panel Operation
- To saving to an external USB flash drive connect the drive to the front or rear panel USB port. If a USB drive is not connected, files can be saved to the internal memory.
 - Press the *Save/Recall* key from the front panel.

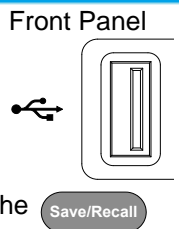

3. Press *Save Setup* from the bottom menu.
4. Press *To* (internal memory) or *To File* and choose a destination to save to.



To Set1~Set20
To File DSxxxx.set

5. Press *Save* to confirm saving. When completed, a message appears at the bottom of the display.
6. If you are saving to a file, a file utility appears where you will be able to edit the name of the file from the default "DSxxxx" filename.
7. To edit the filename, use the *Variable* knob to highlight a character.

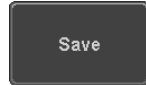

Press *Enter Character* or the *Select* key to select a number or letter.

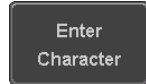

Press *Back Space* to delete a character.

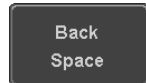

8. Press *Save Now* to save the file. The filename need not have been edited to save the file.

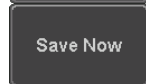

Note: Pressing *Cancel* will cancel the save operation and return you to the *Save/Recall* menu.

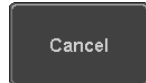



After *Save Now* has been pressed the file will be saved.

Setup saved to USB : /DS0001.SET.

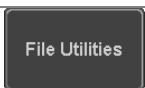

Note

The file will not be saved if the power is turned off or the USB drive is taken out before the message ends.

File Utility	To edit the internal memory or the USB flash drive contents (create/delete/ rename files and folders) or to set the file path, press <i>File Utilities</i> . For details, see 148.	
Edit Label	To edit labels for Setup files, press <i>Edit Label</i> . For more details on editing labels, see page 135.	

5-4. Recall

5-4-1. File Type/Source/Destination

Item	Source	Destination
Default Panel Setup	<ul style="list-style-type: none"> Factory installed setting 	<ul style="list-style-type: none"> Current front panel
Reference Waveform	<ul style="list-style-type: none"> Internal memory: Ref1~4 	<ul style="list-style-type: none"> Current front panel
Panel Setup (DSxxxx.set)	<ul style="list-style-type: none"> Internal memory: S1 ~ 20 File system: Disk, USB 	<ul style="list-style-type: none"> Current front panel
Waveform Data (DSxxxx.Isf, DSxxxx.csv**) (CH1~CH4.Isf, Ref1~Ref4.Isf, Math.Isf)*	<ul style="list-style-type: none"> Internal memory: Wave 1 ~ 20 File system: Disk, USB 	<ul style="list-style-type: none"> Reference waveform Ref1 ~ 4

*Recalled from ALLXXX directories. Note that Allxxxx.csv cannot be recalled to the oscilloscope.



**Detail CSV files cannot be recalled to the oscilloscope.

5-4-2. Recall Default Panel Setting



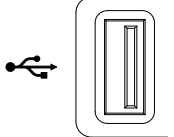

Panel Operation	<ol style="list-style-type: none"> Press the <i>Default</i> key. The screen will update with the default panel settings. 	
Setting Contents	The following is the default (factory) setting contents.	
Acquire	Mode: Sample Record Length: 10k	XY: OFF Expand: By Center

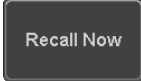
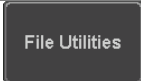
Display	Mode: Vector Waveform intensity: 50% Backlight Intensity: 80% Time: 10min	Persistence: 240ms Graticule intensity: 50% Backlight Auto-dim: On Graticule: full 
Channel	Scale: 100mV/Div Coupling: DC Invert: Off Expand: By Ground Probe: Voltage Deskew: 0s	CH1: On Impedance: 1MΩ Bandwidth: full Position: 0.00V Probe attenuation: 1x
Cursor	Horizontal cursor: Off	Vertical Cursor: Off
Measure	Source: CH1 Display All: Off Statistics: Off	Gating: Screen High-Low: Auto Mean & Std Dev Samples: 2
	High Ref: 90.0% Low Ref: 10.0%	Mid Ref: 50.0%
Horizontal	Scale: 10us/Div	Position: 0.000s
Math	Source1: CH1 Source2: CH2 Unit/Div: 200mV	Operator: + Position: 0.00 Div Math Off
FFT	Source: CH1 Window: Hanning Horizontal: 5MHz/div	Vertical Units: dBV RMS Vertical: 20dB
Advanced Math	Expression: CH1+CH2 VAR2: 1 Unit/div: 500mV	VAR1: 0 Position: 0.00Div
APP	App: Go-NoGo, DVM, Datalog, Mount Remote Disk	
Trigger	Type: Edge Coupling: DC Noise Rejection: Off Level: 0.00V Holdoff: 10.0ns	Source: CH1 Alternate: Off Slope: Positive Mode: Auto
Utility	Hardcopy: Save Assign Save To: Image Probe Comp.: 1kHz	Ink Saver: Off File Format: Bmp

5-4-3. Recall Waveform

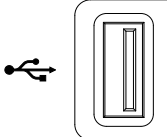
Panel Operation	<p>1. For recalling from an external USB flash drive, connect the drive to the front or rear panel USB port.</p>	<p>Front Panel</p> 
	<p>2. The waveform must be stored in advance. See page 139 for waveform store details.</p> <p>3. Press the <i>Save/Recall</i> key.</p> <p>4. Press <i>Recall Waveform</i> from the bottom menu. The Recall menu appears.</p> <p>5. Press <i>From</i> (internal memory) or <i>From File</i> and choose a source to recall from.</p>	
	<p>From Wave1~20</p> <p>From File* File format: Lsf, Fast Csv</p> <p>*Only files in the current file path will be available, this includes files saved in the ALLxxxx directories.</p> <p>Allxxxx.csv files cannot be recalled to the oscilloscope.</p> <p>Only the “Fast CSV”, “LSF” files can be recalled to the oscilloscope.</p>	
	<p>6. Press <i>To</i> and select the reference waveform to recall to.</p>	
	<p>To Ref1~4</p> <p>7. Press <i>Recall Now</i> to recall the waveform. The reference waveform will appear on the screen when successful.</p>	
File Utility	<p>To edit USB flash drive contents (create/ delete/ rename files and folders) or to set the file path, press <i>File Utilities</i>. For details, see page 148.</p>	

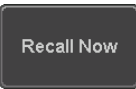
5-4-4. Recall Setup

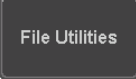
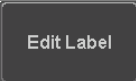
Panel Operation	<p>1. (For recalling from an external USB flash drive) Connect the drive to the front or rear panel USB port.</p>	<p>Front Panel</p> 
	<p>2. Press the <i>Save/Recall</i> key.</p> <p>3. Press <i>Recall Setup</i> from the bottom menu.</p> <p>4. Press <i>From</i> (internal memory) or <i>From File</i> and choose a source to recall from.</p>	
	<p>From Set1~20 From File DSxxxx.set (USB, Disk)* * Only files in the current file path will be available.</p>	
	<p>5. Press <i>Recall Now</i> to confirm recalling. When completed, a message appears at the bottom of the display.</p>	
	<div style="border: 1px solid black; background-color: orange; padding: 5px; display: inline-block;">Setup recalled from Set1.</div>	
	<p> Note The file will not be recalled if the power is turned off or the USB drive is taken out before the message appears.</p>	
File Utility	<p>To edit the internal memory or the USB flash drive contents (create/delete/ rename files and folders) or to set the file path, press <i>File Utilities</i>. For details, see page 148.</p>	
Edit Label	<p>To edit labels for Setup files, press <i>Edit label</i>. For more details on editing labels, see page 135.</p>	

5-5. Reference Waveforms

5-5-1. Recall and Display Reference Waveforms

Panel Operation A reference waveform must be stored in advance. See page 139 to store waveforms as reference waveforms.

1. Press the *REF* key on the front panel.
2. Pressing *R1~R4* repeatedly will toggle the corresponding reference waveform OFF/ON. Turning *R1~R4* ON will open the corresponding reference menu.
3. If a reference waveform is ON but not active, its reference menu can be opened by pressing the corresponding *R1~R4* key from the bottom menu.

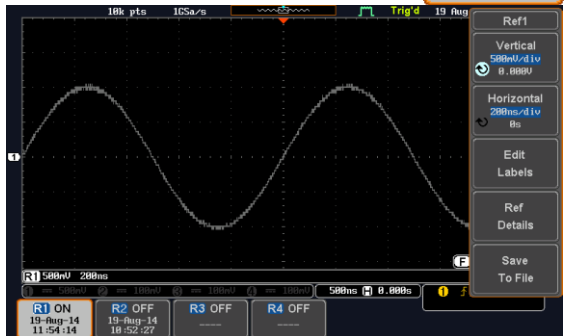
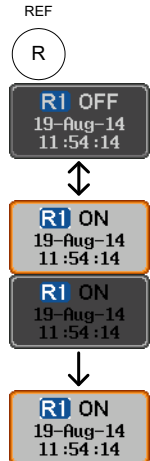

Vertical Navigation

Press *Vertical* repeatedly from the side menu to choose to edit the vertical position or Unit/Div. Use the Variable knob to edit the values.



Horizontal Navigation

Press *Horizontal* repeatedly from the side menu to choose to edit the Time/Div or the horizontal position. Use the Variable knob to edit the value.

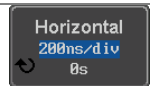

View Reference Waveform Details	Pressing <i>Ref Details</i> will display the reference waveform details.	Ref Details
Details: Sample Rate, Record Length, Date		
<pre> Sample Rate: 1GSps Record Length: 10000 points Date: 19-Aug-14 11:54:14 </pre>		
Edit Labels	To edit labels for Setup files, press <i>Edit Labels</i> . For more details on editing labels, see page 135.	Edit Labels
Save Reference Waveforms	To save reference waveforms, press <i>Save to File</i> . For more details on saving waveforms, see page 139.	Save To File

6. FILE UTILITIES

The file utilities are used each time files need to be saved to internal or external memory. The file utilities can create directories, delete directories, rename files as well as copy files from internal memory to USB. The File Utilities menu also sets the file path for saving and recalling files from the Save/Recall menu.

6-1-1. File Navigation

The File Utilities menu can be used to choose files or to set the file path for saving/recalling files.

File System

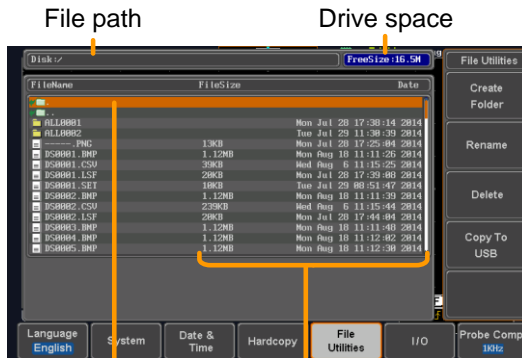

File cursor File attributes

Panel Operation 1. Press the *Utility* key.



2. Press *File Utilities* from the bottom menu.

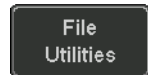

3. The file system appears.

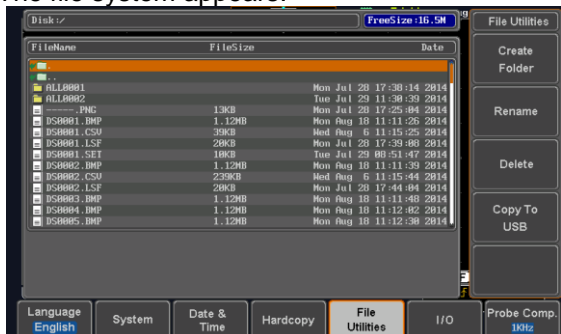

- Use the *Variable* knob to move the file cursor up and down. Use the *Select* key to choose a file or directory or to set the file path.

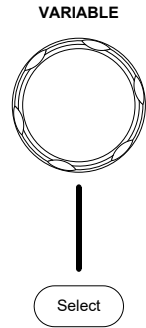

Note

- When a USB flash drive is used, the file path is remembered each time the USB flash drive is used. This saves you the hassle of setting the USB file path each time the USB flash drive is inserted into the scope.

6-1-2. Create Folder

Panel Operation 1. Press the *Utility* key.

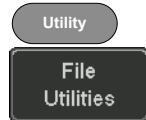

- Press *File Utilities* from the bottom menu.
- Use the *Variable* knob and *Select* key to navigate the file system.

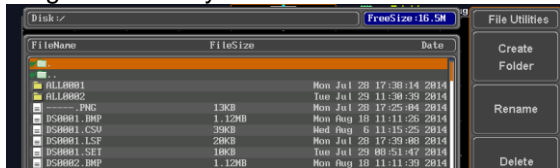

Create Folder

- Press *Create Folder* to make a new directory at the selected location.
- Use the *Variable* knob to highlight a character.



Press *Enter Character* or the *Select* key to select a number or letter.

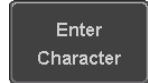

Press *Back Space* to delete a character.

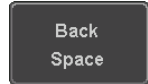

6. Press *Save Now* to create the folder.

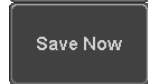

Cancel

Press *Cancel* to cancel the operation.

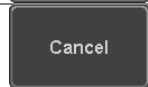

6-1-3. Rename File

Panel Operation 1. Press the Utility key.



2. Press *File Utilities* from the bottom menu.

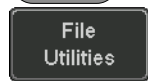

3. Use the Variable knob and select key to choose a file to rename.

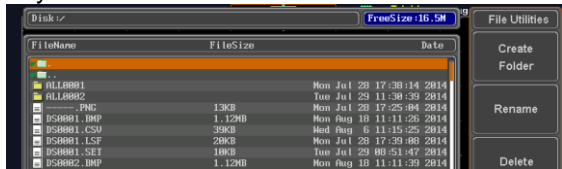

4. Press *Rename* when a file is chosen.

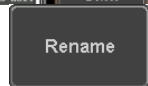

5. Use the *Variable* knob to highlight a character.

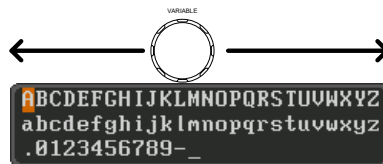

Press *Enter Character* or the *Select* key to select a number or letter.

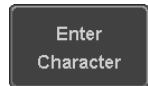

Press *Back Space* to delete a character.



6. Press *Save Now* to rename the folder or file.

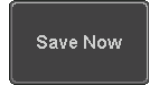

6-1-4. Delete File or Folder

Panel Operation 1. Press the *Utility* key.

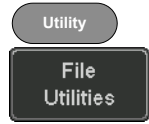

2. Press *File Utilities* from the bottom menu.
3. Use the *Variable* knob and select key to navigate the file system to choose a file.

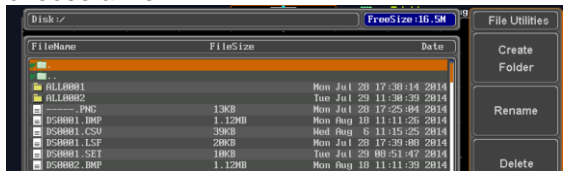

4. Press *Delete* to delete the selected file.
5. Press *Delete* again to confirm the deletion.

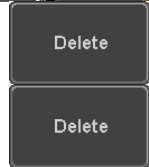

6-1-5. Copy File to USB

Panel Operation 1. Connect a USB drive to the front panel USB port.

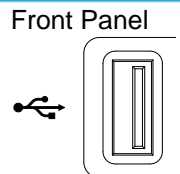

2. Press the *Utility* key.
3. Press *File Utilities* from the bottom menu.
4. Use the *Variable* knob and *Select* key to navigate the file system to choose a file from internal memory.

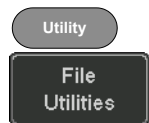

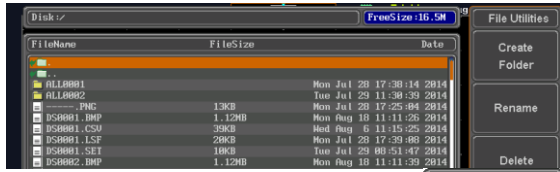

5. Press *Copy to USB* to copy the selected file to the USB drive.



Note

If the same file name already exists on the USB drive, it will be copied over.

6-1-6. Installing Optional Apps and Functions

Overview

The DCS-1000B Series has the optional apps or the optional functions

Panel Operation

1. After copy the option's file to the Front Panel USB drive, Connect the USB drive to the front panel USB port.

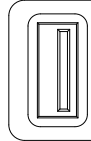

2. Press the *Utility* key.
3. Press *File Utilities* from the bottom menu.
4. Use the *Variable* knob and *Select* key to navigate the file system to choose a file.

Utility

File Utilities

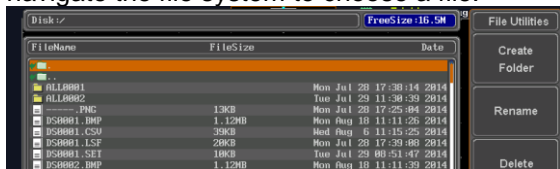

5. Press *Copy to USB* to copy the selected file to the USB drive.
6. When the installation has completed you will be prompted to restart the oscilloscope.

Select

Option Name	File Name
Data log function	:DataLog_1KB.gz
Digital Filter function	:DigitalFilter_1KB.gz
DVM function	:DVM_1KB.gz

7. HARDCOPY

The Hardcopy key is used as quick-save or quick-print key. The Hardcopy key can be assigned either to printout screenshots or to save files.

When assigned to “Print” the screen image can be printed to a PictBridge compatible printer using the USB device port. To reduce the amount of printer ink used for each print, images can be printed using the Ink Saver function.

When assigned to “Save”, pressing the Hardcopy key can be used to save a screen shot, a waveform, or the current setup, depending on the configuration.

7-1-1. Printer I/O Configuration

Panel Operation 1. Connect a PictBridge printer to the USB device port on the rear panel.

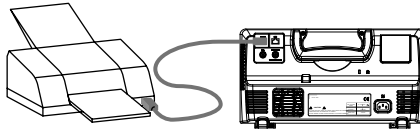

2. Press the *Utility* key.
3. Press *I/O* from the bottom menu.
4. Press *USB Device Port* from the side menu and select *Printer*.

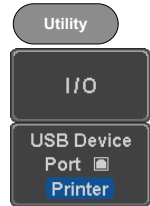

7-1-2. Print Output

Ensure the USB port has been configured for the printer and the printer is connected to the scope before trying to print.

- Panel Operation 1. Press the *Utility* key.
2. Press *Hardcopy* from the bottom menu.
 3. On the side menu, press *Function* and select *Print*.
 4. Press the *Hardcopy* key to print. The display image is printed out.



Ink Saver

To have a white background on the printed display image, set *Ink Saver* to On.

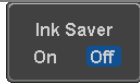

Ink Saver On

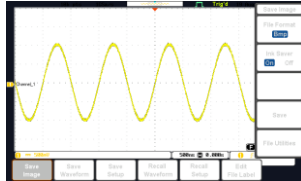

Ink Saver Off

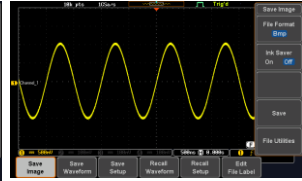

7-1-3. Save - Hardcopy Key

Background

When the Hardcopy key is assigned to "Save", pressing the Hardcopy key can be used to save a screen shot, a waveform, or the current setup, depending on the configuration.

Panel Operation

1. If you wish to save to USB, connect a USB drive to the front panel USB port, otherwise the file will save to internal memory.

Front

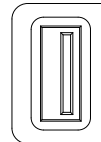

2. Press the *Utility* key.
3. Press *Hardcopy* from the bottom menu.
4. On the side menu, press *Function* to select Save.
5. Press *Assign Save To* and select which type of file will be saved when the Hardcopy key is pressed.



6. Press the *Hardcopy* key to save the file*.

HARDCOPY

A message will appear when the save is successful.



Image File Format

1. For image files the file format can be selected with the *File Format* key.

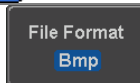

Ink Saver

- Format: BMP, PNG
2. To have a white background for image files, set *Ink Saver* to On.

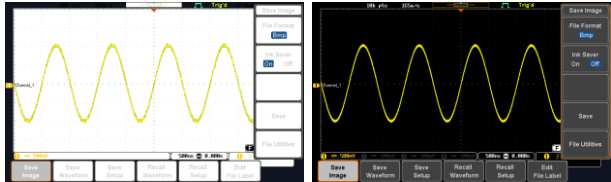
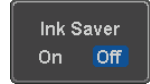

Ink Saver On

Ink Saver Off



Note

*Each time the Hardcopy key is used to save waveforms or setup files, the files are saved into a new directory each time. The save directory is labeled ALLXXXX, where XXXX is a number that is incremented with each save. This directory is created in either the internal memory or to a USB flash drive.

8. REMOTE CONTROL

This chapter describes basic configuration for remote control. For a command list, refer to the programming manual.

8-1-1. Configure USB Interface

USB Configuration	PC side connector	Type A, host
	DCS-1000B side connector	Type B, device
	Speed	1.1/2.0
	USB Class	USB-CDC
	OS	Windows7 or higher (32bit/64bit)
	USB Driver	TEXIO_CDC*.inf

Panel Operation

1. Press the Utility key.
2. Press *I/O* from the bottom menu.
3. Press *USB Device Port* from the side menu and select *Computer*.
4. Connect the USB cable to the rear panel device port.
5. When the PC asks for the USB driver or 'Unknown device' listed in Device Manager, install TEXIO-CDC*.inf.
6. If the computer can not recognize the new hardware due to the security, please go to update the driver from the "Other devices" in the Device Manager.



Note

You must have administrator account to install driver.

8-1-2. Configure the Ethernet Interface

Ethernet Configuration	MAC Address	Domain Name
	Instrument Name	DNS IP Address
	User Password	Gateway IP Address
	Instrument IP Address	Subnet Mask
		HTTP Port 80 (fixed,stopped)

Background

The Ethernet interface is used for remote control using a socket server connection. For details, please see the Socket Server section on page 158.

Panel Operation 1. Connect the Ethernet cable to the LAN port on the rear panel.



2. Press the *Utility* key.
3. Press *I/O* from the bottom menu.
4. Press *Ethernet* from the side menu.
5. Set *DHCP/BOOTP* to *On* or *Off* from the side menu.



IP addresses will automatically be assigned with DHCP/BOOTP set to on. For Static IP Addresses, DHCP/BOOTP should be set to off.

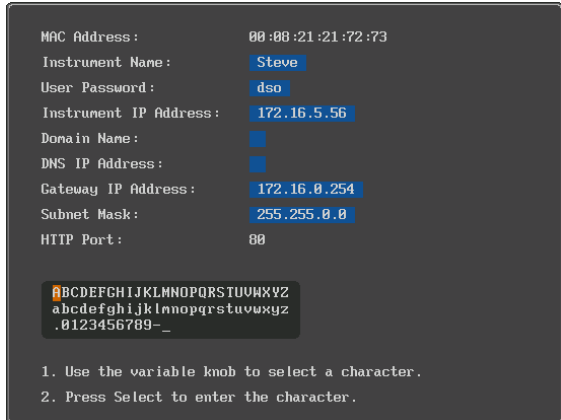

6. Use the *Up* and *Down* arrows on the side menu to navigate to each Ethernet configuration item.

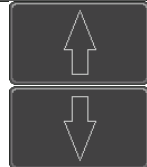

Items MAC Address, Instrument Name, User Password, Instrument IP Address, Domain Name, DNS IP Address, Gateway IP Address, Subnet Mask
Note: HTTP Port is fixed at 80.

- Use the *Variable* knob to highlight a character and use the *Select* key to choose a character.

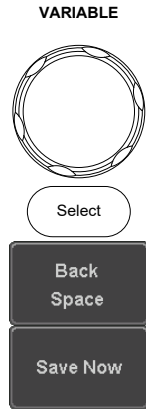

Press *Backspace* to delete a character.

Press *Save Now* to save the configuration. Complete will be displayed when successful.

8-1-3. Configure Socket Server

The DCS-1000B supports socket server functionality for direct two-way communication with a client PC or device over LAN. By default, the Socket Server is off.

Configure Socket Server

- Configure the IP address for the DCS-1000B. Page 156
- Press the *Utility* key.
- Press *I/O* from the bottom menu.
- Press *Socket Server* from the side menu.
- Press *Select Port* and choose the port number with the Variable knob.
Range 1024~65535
- Press *Set Port* to confirm the port number.
- The Current Port icon will update to the new port number.
- Press *Server* and turn the socket server On.

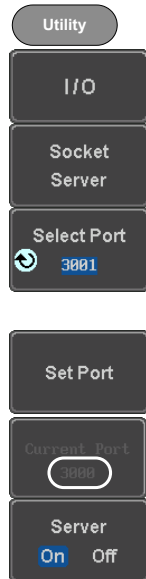

8-1-4. USB Functionality Check

Terminal Application Invoke a terminal application such as RealTerm. Set the COM port, baud rate, stop bit, data bit, and parity accordingly. Set the delimiter and the local echo as necessary. To check the COM port number and associated port settings, see the Device Manager in the PC. For Windows 7:
Control panel → *Hardware and Sound* → *Device Manager*

Example: Configuring RealTerm:

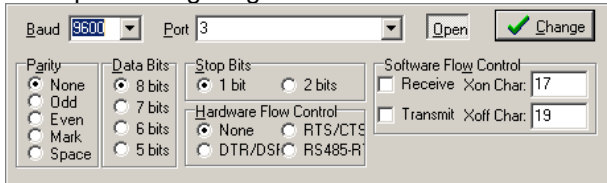

Functionality Check Key in this query command via the terminal application.

*idn?

This should return the Manufacturer, Model number, Serial number, and Firmware version in the following format.

TEXIO,DCS-1102B,PXXXXXX,V1.00



Note

For further details about remote control and remote commands, please see the DCS-1000B programming manual.

8-1-5. Socket Server Functionality Check

NI Measurement and Automation Explorer To test the socket server functionality, National Instruments MAX (Measurement and Automation Explorer) can be used. This program is available on the NI website, www.ni.com.

The following display and operation will differ depending on the version of MAX, Please use in accordance with the display for your MAX.

- | | | |
|-----------|--|---|
| Operation | 1. Configure the IP address for the DCS-1000B. | Page 156 |
| | 2. Configure the socket port. | Page 158 |
| | 3. Start the NI Measurement and Automation Explorer (MAX) program. Using Windows, press: |  |

Start>All Programs>National Instruments>Measurement & Automation



4. From the Configuration panel access; *My System>Devices and Interfaces>Network Devices*
5. Right click *Network Devices* and select *Create New Visa TCP/IP Resource...*

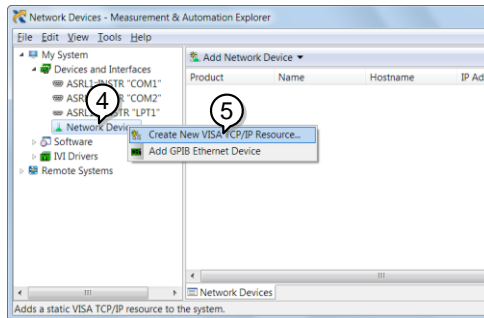

6. Select *Manual Entry of Raw Socket* from the popup window.
7. Click *Next*.



8. Enter the DCS-1000B's IP address and socket port number.
9. Click *Validate*.
10. A popup will appear to tell you if a VISA socket session was successfully created.
11. Click *Next*.

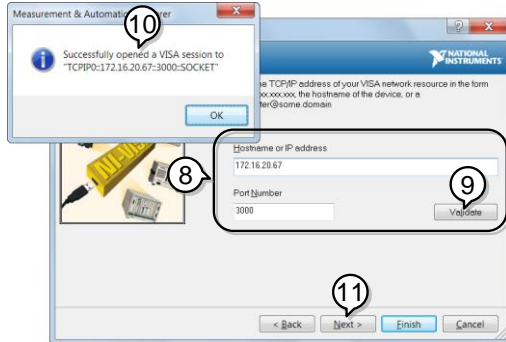

12. Choose an alias for the socket connection if you like.
13. Click *Finish* to finish the configuration.



14. The DCS-1000B will now appear under Network Devices in the Configuration Panel.

Functionality
Check

15. Click the *Open Visa Test Panel* to send a remote command to the DCS-1000B.

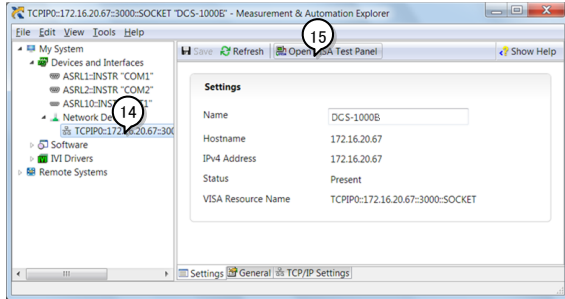

16. Click on the *Configuration* icon.
17. Select the *I/O Settings* tab.
18. Mark the *Enable Termination Character* checkbox. Make sure the termination character is a line feed (/n, value: xA).
19. Click *Apply Changes*.

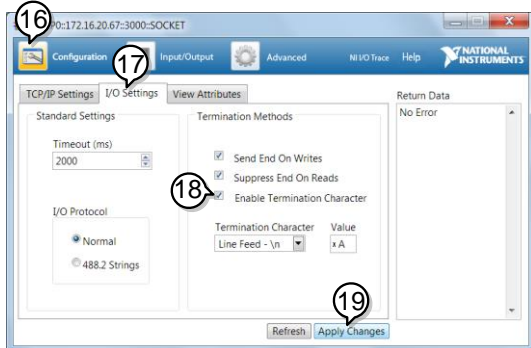

20. Click the *Input/Output* icon.
21. Make sure the **IDN?* query is selected in the *Select or Enter Command* drop box.
22. Click on *Query*.
23. The manufacturer, model number, serial number and firmware version will be displayed in the buffer. For example:
 TEXTIO,DCS-1202E,PXXXXXX,V1.00

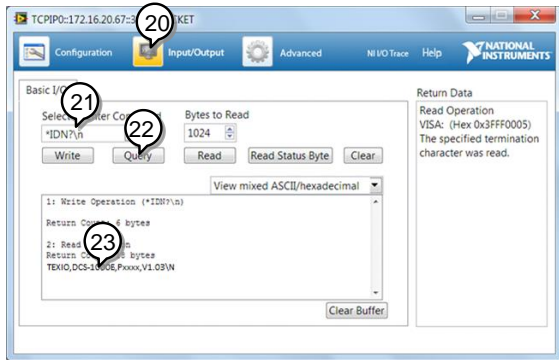

Note

For further details about remote control and remote commands, please see the DCS-1000B programming manual.

9. MAINTENANCE

Three types of maintenance operations are available:

- Signal Path Compensation (SPC)
 - calibrate vertical accuracy
 - compensate the probe.

Run these operations when using the DCS-1000B in a new environment.

9-1-1. How to use SPC function

Background Signal Path Compensation (SPC) is used to compensate the internal signal path due to ambient temperature. SPC is able to optimize the accuracy of the oscilloscope with respect to the ambient temperature.

- Panel Operation**
1. Press the *Utility* key.
 2. Press *System* from the bottom menu.
 3. Press *SPC* from the side menu. A message showing a brief introduction to SPC appears on the screen.

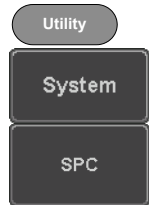

Disconnect all probes and cables from all channels before calibrating.

The DSO needs to be warmed up for at least 30 minutes before using the SPC function.

4. Press *Start* on the side menu to start SPC calibration.
5. The SPC Calibration will proceed one channel at a time, from channel 1 to channel 4.

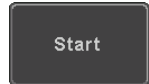

9-1-2. Vertical Accuracy Calibration

- Panel Operation**
1. Press the *Utility* key.
 2. Press *System* from the bottom menu.
 3. Press *more 1 of 3* from the side menu.
 4. Press *Self Cal* on the side menu.

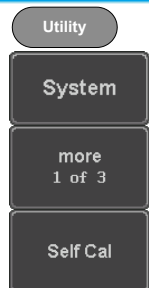

5. Press *Vertical* on the side menu.

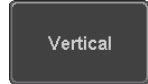

6. A message appears to “Now performing vertical calibration...”

CH1

Connect the CAL output to channel, then press the Vertical key”.

7. Connect the calibration signal from the rear panel to the Channel 1 input with a BNC cable. It will use very low level signal, please use the cable with the high shield effect and short.

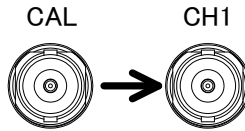

8. Press *Vertical* again after connecting CAL to the channel 1 input.

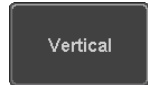

The calibration for Channel 1 starts and ends automatically, in less than 5 minutes.

A message is displayed when the calibration procedure has ended.

9. Repeat the above step for Channel 2, 3* and 4* when prompted.

*4 channel models only.

10. When the calibration for all channels has completed, the display goes back to the default state.

9-1-3. Probe Compensation

- Panel Operation
1. Connect the probe between the Channel 1 input and the probe compensation output (default set as 2Vp-p, 1kHz square wave) on the front panel. Set the probe attenuation to x10.
 2. Alternatively, the probe compensation frequency can be changed. See page 117 for details.

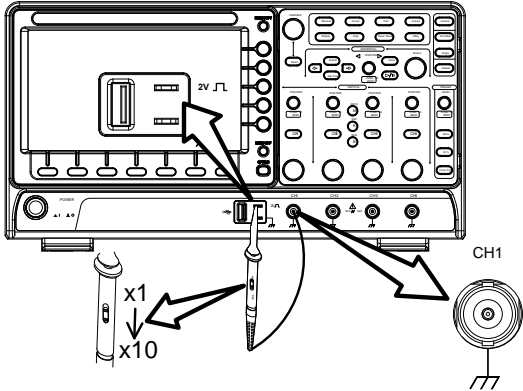

3. Press the *CH1* key to activate CH1.
4. Set the *Coupling* to DC from the bottom menu.
5. Set the Probe attenuation to *Voltage, 10X*.
6. Press the *Autoset* key. The compensation signal appears on the display.
7. Press the *Display* key, then set the display type to *Vector*.

CH1

Coupling
DC AC GND

Page 73

Autoset

Display →

Dot Vector

8. Turn the adjustment point on the probe to make the waveform as square as possible.

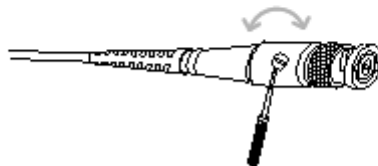
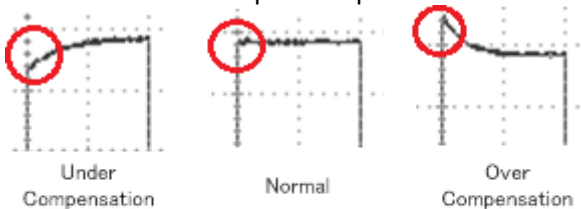

10. APPENDIX

10-1. FAQ

- I connected the signal but it does not appear on the display.
 - I want to remove the (Measurement result / FFT result / Help contents) from the display.
 - The waveform does not update (frozen).
 - The probe waveform is distorted.
 - Autoset does not catch the signal well.
 - The display image printout is too dark on the background.
 - The accuracy does not match the specification.
-
- **I connected the signal but it does not appear on the display.**
Make sure you have activated the channel by pressing the Channel key (the channel key lights up).
 - **I want to remove the (Measurement result / FFT result / Help contents) from the display.**
To clear automatic measurement results, press the Measure key, select Remove Measurement and choose Remove All. See page 28.
To clear individual measurements from the screen, press the Measure key, select Display All and choose Off. See page 29.
To clear the FFT result, press the Math key twice. See page 39 for details.
To clear Help result, press the Help key again. See page 18 for details.
 - **The waveform does not update (frozen).**
Press the Run/Stop key to unfreeze the waveform. See page 21 for details.
If this does not help, the trigger mode might be set to Single. Press the Single key to exit Single mode. See page 21 for Single trigger details.
 - **The probe waveform is distorted.**
You might need to compensate the probe.

- **Autoset does not catch the signal well.**
The Autoset function cannot catch signals under 30mV or 20Hz. Please use the manual operation. See page 20 for Autoset details.
- **The display image printout is too dark on the background.**
Use the Ink Saver function which reverses the background color. For details, see page 153.
- **The accuracy does not match the specification.**
Make sure the device is powered On for at least 30 minutes, within +20°C~+30°C. This is necessary to stabilize the unit to match the specification.

For more information, contact your local dealer or TEXIO TECHNOLOGY at <https://www.texio.co.jp> / or mail to info@texio.co.jp.

10-2. Updating the Firmware

Background New firmware can be downloaded from the TEXIO website in the DSO products section. Place a copy of the firmware onto the root directory of a USB memory stick.

1. Prepare a USB memory that has been formatted in FAT32 with all the contents erased, and copy only the firmware update file (*.Upg).
2. Change the language setting to English in the UTIL menu of DSO, and clear the settings with the default key.
3. Turn off the DSO power, insert a USB memory, turn on the Variable knob while turning on the power, and then search for memory and then display the display.

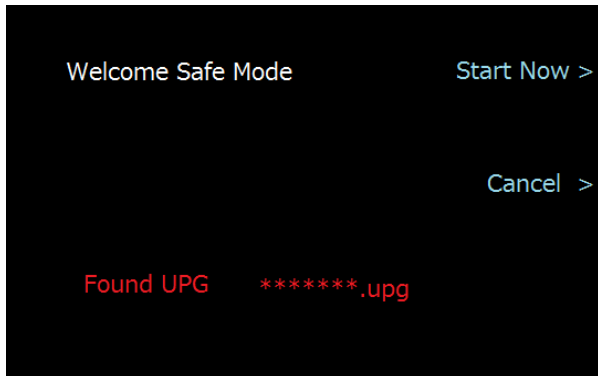

If the UPG file cannot be recognized, replace it with another USB memory and do the same procedure.

4. Press the key beside "Start Now" to start the update, wait until the yellow status bar is full.
 5. When "Update Nand Flash Success" is displayed, it is completed. Turn off the power and remove the USB memory.
 6. Turn on the power and check the version (UTIL key → system → system info).
-

10-3. SPECIFICATIONS

10-3-1. Model Specifications

DCS-1052B	Channels	2 + Ext
	Bandwidth	DC ~ 50MHz (-3dB)
	Rise Time	7ns
	Bandwidth Limit	20MHz
DCS-1054B	Channels	4
	Bandwidth	DC ~ 50MHz (-3dB)
	Rise Time	7ns
	Bandwidth Limit	20MHz
DCS-1072B	Channels	2 + Ext
	Bandwidth	DC ~ 70MHz (-3dB)
	Rise Time	5ns
	Bandwidth Limit	20MHz
DCS-1074B	Channels	4
	Bandwidth	DC ~ 70MHz (-3dB)
	Rise Time	5ns
	Bandwidth Limit	20MHz
DCS-1102B	Channels	2 + Ext
	Bandwidth	DC ~ 100MHz (-3dB)
	Rise Time	3.5ns
	Bandwidth Limit	20MHz
DCS-1104B	Channels	4
	Bandwidth	DC ~ 100MHz (-3dB)
	Rise Time	3.5ns
	Bandwidth Limit	20MHz

10-3-2. Common Specifications

Vertical Sensitivity	Resolution	8 bit: 1mV~10V/div
	Input Coupling	AC, DC, GND
	Input	1M Ω // 16pF approx.
	Impedance	
	DC Gain	1mV: \pm 4% full scale
	Accuracy	>2mV: \pm 3% full scale
	Polarity	Normal & Invert
	Maximum Input Voltage	300Vrms
	Offset	1mV/div : \pm 1.25V
	Position	2mV/div ~ 100mV/div : \pm 2.5V
	Range	200mV/div ~ 10V/div : \pm 125V
	Waveform	+, -, x, \div , FFT, FFTrms, User Defined
	Signal	Expression
	Process	FFT: Spectral magnitude. Set FFT Vertical Scale to Linear RMS or dBV RMS, and FFT Window to Rectangular, Hamming, Hanning, or Blackman-Harris

Trigger	Source	CH1, CH2, CH3*, CH4*, Line, EXT** *four channel models only. **two channel models only.	
	Trigger Mode	Auto (supports Roll Mode for 100 ms/div and slower), Normal, Single Sequence	
	Trigger Type	Edge, Pulse Width(Glitch), Video, Pulse Runt, Rise & Fall(Slope), Timeout, Alternate, Event-Delay(1~65535 events), Time-Delay(Duration, 4nS~10S), Bus	
	Holdoff range	4ns to 10s	
	Coupling	AC, DC, LF rej., Hf rej., Noise rej.	
	Sensitivity	1 div	
External Trigger	Range	±2.5V	
	Sensitivity	DC ~ 100MHz Approx. 100mV	
	Input Impedance	1MΩ±3%~16pF	
Horizontal	Timebase Range	5ns/div ~ 100s/div (1-2-5 increments)	
	Range	ROLL: 100ms/div ~ 100s/div	
	Pre-trigger	10 div maximum	
	Post-trigger	2,000,000 div maximum	
	Timebase Accuracy	±50 ppm over any ≥ 1 ms time interval	
	Real Time Sample Rate	1GSa/s max.	
	Record Length	Max. 10Mpts	
	Acquisition Mode	Normal, Average, Peak Detect, Single	
	Peak Detection	2nS (typical)	
	Average	selectable from 2 to 256	
	X-Y Mode	X-Axis Input	Channel 1; Channel 3* *four channel models only
		Y-Axis Input	Channel 2; Channel 4* *four channel models only
		Phase Shift	±3° at 100kHz
	Cursors and Measurement	Cursors	Amplitude, Time, Gating available; Unit: Seconds(s), Hz(1/s), Phase(degree), Ration(%)
Automatic Measurement		36 sets: Pk-Pk, Max, Min, Amplitude, High, Low, Mean, Cycle Mean, RMS, Cycle RMS, Area, Cycle Area, ROVShoot, FOVShoot, RPREShoot, FPRESshoot, Frequency, Period, RiseTime, FallTime, +Width, -Width, Duty Cycle, +Pulses, -Pulses, +Edges, -Edges, FRR, FRF, FFR, FFF, LRR, LRF, LFR, LFF, Phase	

	Cursors measurement	Voltage difference between cursors (ΔV) Time difference between cursors (ΔT)
	Auto counter	6 digits, range from 2Hz minimum to the rated bandwidth
Control Panel Function	Autoset	Single-button, automatic setup of all channels for vertical, horizontal and trigger systems, with undo Autoset
	Save Setup	20set
	Save Waveform	24set
Display	TFT LCD Type	7" TFT WVGA color display
	Display Resolution	800 horizontal x 480 vertical pixels (WVGA)
	Interpolation	Sin(x)/x
	Waveform Display	Dots, vectors, variable persistence (16ms~4s), infinite persistence
	Waveform Update Rate	50,000 waveforms per second, maximum
	Display Graticule	8 x 10 divisions
	Display Mode	YT, XY
	Interface	USB Port
Ethernet Port (LAN)		RJ-45 connector, 10/100Mbps with HP Auto-MDIX (4ch Model Only)
Go-NoGo BNC		5V Max/10mA TTL open collector output
Kensington Style Lock		Rear-panel security slot connects to standard Kensington-style lock
Power Source	Line Voltage	100V~240V AC \pm 10% , 50Hz~60Hz
	Power Consumption	30W, 45VA maximum
Miscellaneous	Menu Operation Environment	Multi-language manu Available Temperature: 0°C to 50°C. Relative Humidity \leq 80% at 40°C or below; \leq 45% at 41°C ~ 50°C
	Dimensions	384mm X 208mm X 127.3mm
	Weight	2.8kg
	Environment	Indoor , Altitude < 2000m Overvoltage category: OVC II
	LVD	EN61010-1(Class1,Pollution degree 2) conformity of 2014/35/EU
	EMC	EN61326-1 (ClassA), conformity of 2014/30/EU

10-3-3. Probe Specifications

10-3-3-1. For DCS-1052B/1054B/1072B/1074B

Model		GTP-070B-4
Position x10	Attenuation Ratio	10:1
	Bandwidth	DC ~ 70MHz
	Input Resistance	10M Ω when used with oscilloscopes with 1M Ω input.
	Input Capacitance	14.5pF~17.5pF
	Compensation Range	10pF ~ 35pF
	Max. Input Voltage	\leq 600V DC + ACpk
Position x1	Attenuation Ratio	1:1
	Bandwidth	DC ~ 10MHz
	Input Resistance	1M Ω when used with 1M Ω input
	Input Capacitance	85pF~115pF
	Max. Input Voltage	\leq 200V DC + ACpk
Operating Cond.	Temperature	-10°C ~ 50°C
	Relative Humidity	\leq 85%

10-3-3-2. For DCS-1102B/1104B

Model		GTP-100B-4
Position X10	Attenuation Ratio	10:1
	Bandwidth	DC ~ 100MHz
	Input Resistance	10M Ω when used with oscilloscopes with 1M Ω input.
	Input Capacitance	14.5pF~17.5pF
	Compensation Range	5 ~ 30pF
	Max. Input Voltage	\leq 600V DC + ACpk
Position X1	Attenuation Ratio	1:1
	Bandwidth	DC ~ 10MHz
	Input Resistance	1M Ω (Oscilloscope Input)
	Input Capacitance	85pF~115pF
	Max. Input Voltage	\leq 200V DC + ACpk
Operating Cond.	Temperature	-10°C ~ 50°C
	Relative Humidity	\leq 85%

Note:We reserves the right to change the probe model type at anytime without notice for probe model types of similar specification.

10-4. DIMENSIONS

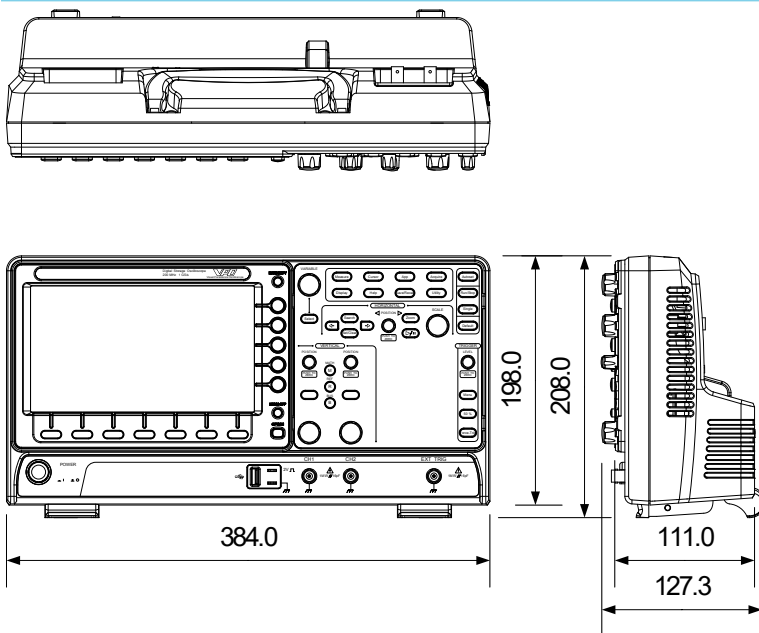



TEXIO TECHNOLOGY CORPORATION

7F Towa Fudosan Shin Yokohama Bldg., 2-18-13, Shin Yokohama, Kohoku-ku,
Yokohama, Kanagawa, 222-0033, Japan.

<https://www.texio.co.jp/>
